

### Features

- LO 10 TO 1000 MHz
- RF 10 TO 1000 MHz
- F DC TO 600 MHz
- LO DRIVE: +20 dBm (nominal)
- HIGH INTERCEPT POINT: +30 dBm (TYP.)
- HERMETICALLY SEALED

### Description

The M2E is a double balanced mixer, designed for use in military, commercial, and test equipment applications. The design utilizes Schottky ring quad diodes and broadband ferrite baluns to attain excellent performance. This mixer can also be used as a phase detector and/or bi-phase modulator since the IF port is DC coupled to the diodes. Environmental screening is available to MIL-STD-883, MIL-STD-202, or MIL-DTL-28837, consult factory.

### Ordering Information

Part Number	Package
M2E	TO-8
M2EC	SMA Connectorized
SM2E	Surface Mount

### Product Image

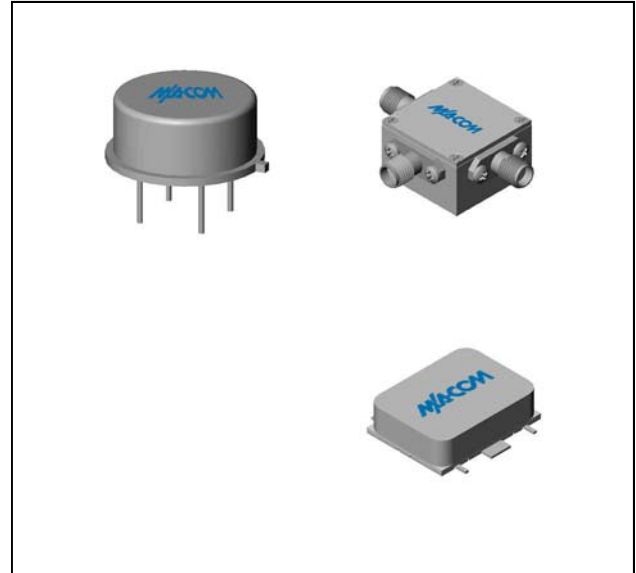

### Electrical Specifications: $Z_0 = 50\Omega$ $Lo = +20$ dBm (Downconverter application only)

Parameter	Test Conditions	Units	Typical	Guaranteed	
				+25°C	-54° to +85°C *
SSB Conversion Loss (max) & SSB Noise Figure (max)	fR = 0.01 to 0.3 GHz, fL = 0.01 to 0.3 GHz, fl = 0.01 to 0.2 GHz	dB	7.0	7.5	7.8
	fR = 0.01 to 0.3 GHz, fL = 0.01 to 0.3 GHz, fl = 0.01 to 0.6 GHz	dB	8.0	9.0	9.3
	fR = 0.01 to 1 GHz, fL = 0.01 to 1 GHz, fl = 0.01 to 0.2 GHz	dB	8.5	9.5	9.8
	fR = 0.01 to 1 GHz, fL = 0.01 to 1 GHz, fl = 0.01 to 0.6 GHz	dB	10.0	11.0	11.3
Isolation, L to R (min)	fL = 0.01 to 0.1 GHz	dB	40	35	34
	fL = 0.1 to 0.4 GHz	dB	35	25	24
	fL = 0.4 to 1 GHz	dB	25	18	17
Isolation, L to I (min)	fL = 0.01 to 0.1 GHz	dB	45	35	34
	fL = 0.1 to 0.4 GHz	dB	35	25	24
	fL = 0.4 to 1 GHz	dB	20	14	13
1 dB Conversion Comp.	fL = +25 dBm	dBm	+20		
Input IP3		dBm	+30		

\* The M2EC specification limits apply at 0°C to +50°C.

### Typical Performance Curves

**Conversion Loss vs. Frequency**

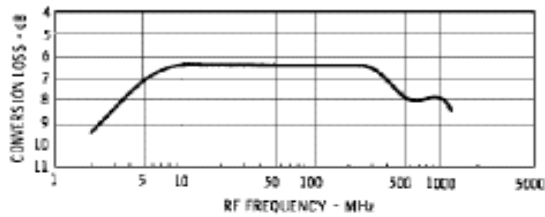

$f_{LO} > f_{RF}$   
 $P_{LO} = +20 \text{ dBm}$   
 $P_{RF} = -10 \text{ dBm}$   
 $f_{IF} = \text{BETWEEN } 1 \text{ MHz and } 100 \text{ MHz}$

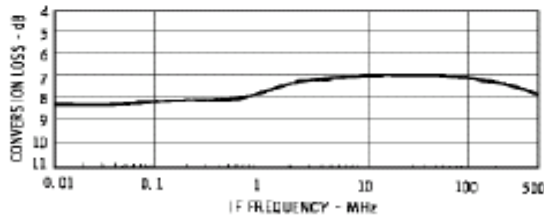

$f_{LO} > f_{RF}$   
 $P_{LO} = +20 \text{ dBm}$   
 $f_{RF} = 100 \text{ MHz @ } -10 \text{ dBm}$

**Conversion Loss vs. LO Drive**

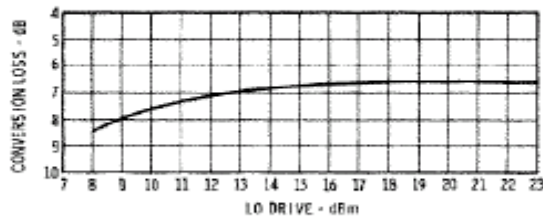

$f_{LO} = 400 \text{ MHz}$   
 $f_{RF} = 300 \text{ MHz @ } -10 \text{ dBm}$

**Isolation**

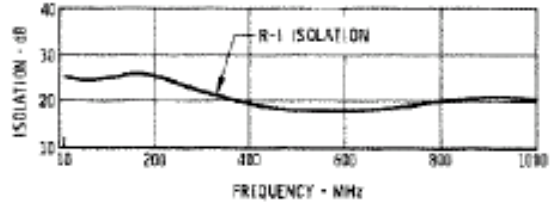
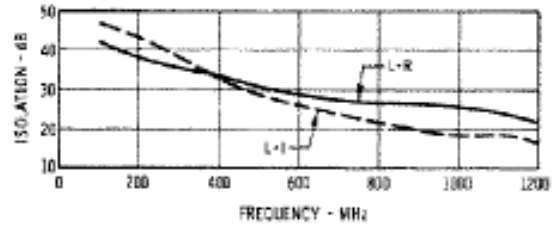

$f_{LO} = 700 \text{ MHz @ } +20 \text{ dBm}$   
 $P_{RF} = -10 \text{ dBm}$

**VSWR**

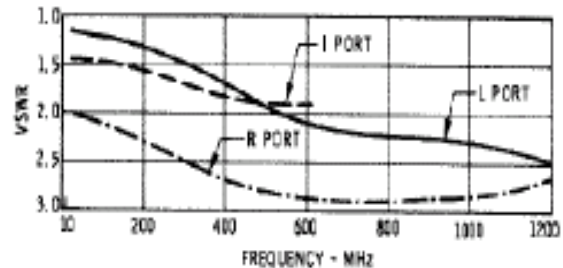

$P_{RF} = P_{IF} = -10 \text{ dBm}$   
 $P_{LO} = +20 \text{ dBm}$   
 $f_{LO} = 1000 \text{ MHz}$

## Double-Balanced Mixer

Rev. V4

### Absolute Maximum Ratings

Parameter	Absolute Maximum
Operating Temperature	-54°C to +100°C
Storage Temperature	-65°C to +100°C
Peak Input Power	+27 dBm max @ +25°C dBm max @ +100°C
Peak Input Current	100 mA DC

### Outline Drawing: TO-8 \*

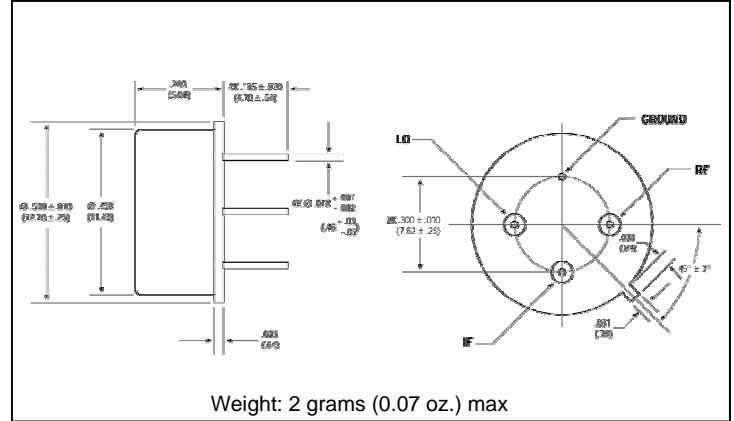

### Outline Drawing: SMA Connectorized \*

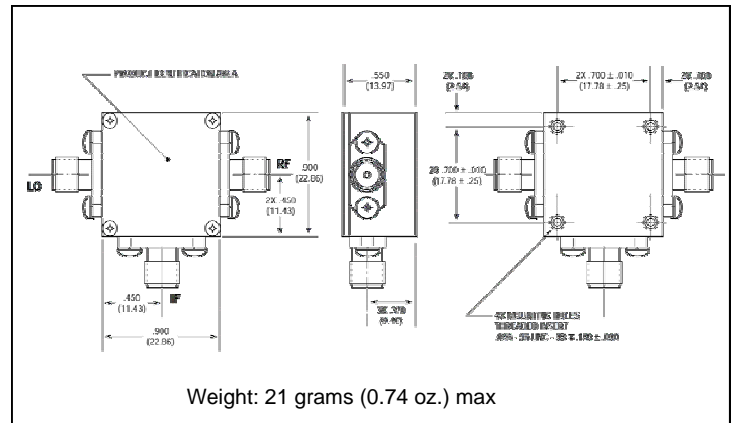

\* Dimensions are inches (millimeters) ±0.015 (0.38) unless otherwise specified.

### Outline Drawing: Surface Mount \*

