

## Metal Film Fusing Resistors

Type: **ERQA**  
**ERQZ**  
 (0.25 W, 0.5 W, 1 W, 2 W coating type )



This series is not a recommended product.  
 Not recommended for new design.

### Features

- Accurate fusing
- Small size and lightweight
- Uniform quality, consistent performance and reliability
- Flame retardant, utilizing exclusive silicon insulation material
- Reference Standard  
EIAJ RC-2125
- RoHS compliant

### Explanation of Part Numbers

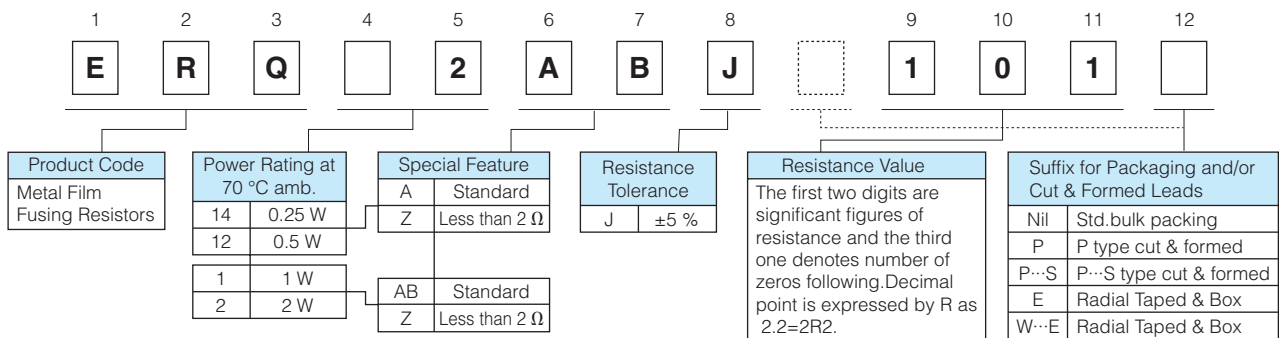

The above example shows a standard Metal Film Fusing Resistors, 2 W power rating, resistance value of 100 Ω, tolerance of ±5 %, and package of standard bulk packing.

### Construction

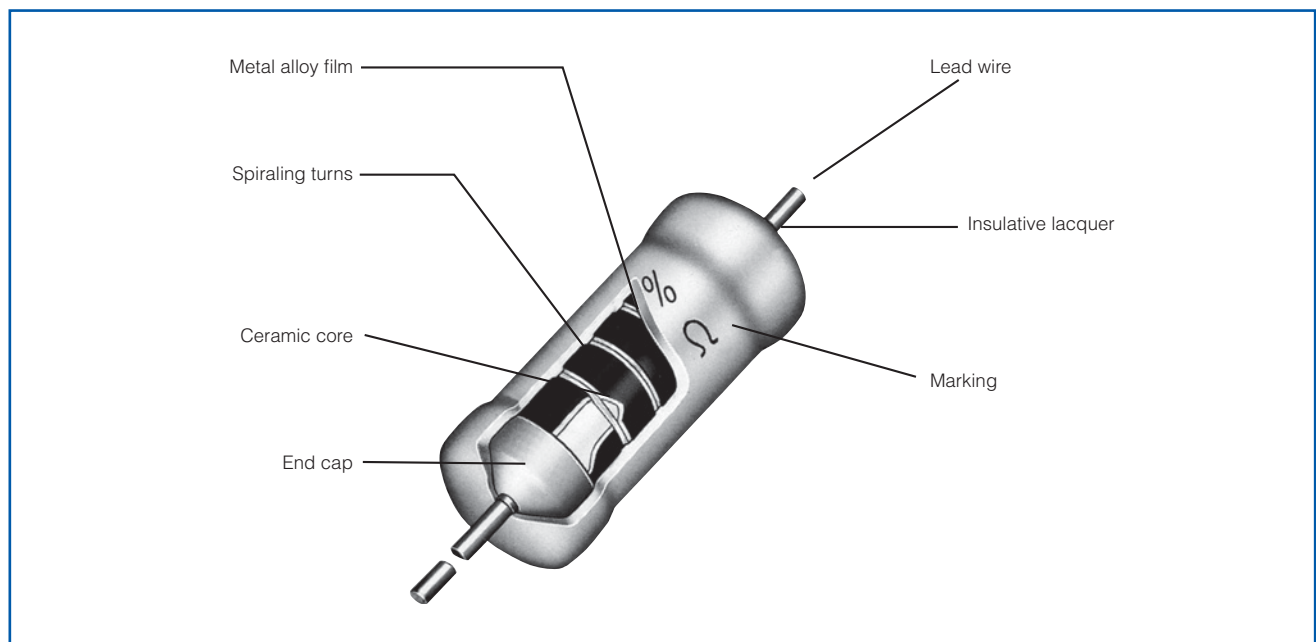

## Ratings

Part No.	Power Rating at 70°C (W)	Maximum Open Circuit Voltage <sup>(1)</sup> (V)	Maximum Overload Voltage	Dielectric With-standing Voltage (V)	Resistance Tolerance (%)	Resistance Range (Ω)		T.C.R. (× 10 <sup>-6</sup> /°C)	Standard Resistance Values	Marking Method on Body	Mass (Weight) [g/pc.]
						min.	max.				
ERQ14Z ERQ14A	0.25	200	3 times of rated voltage <sup>(2)</sup>	AC 350	J (± 5)	1.0	1.8	±350	E24	Color code	0.24
2.0						470					
ERQ12Z ERQ12A	0.5	250		AC 350	J (± 5)	1.0	1.8	±350	E24	Stamp	0.32
2.0						560	Color code				
ERQ1Z ERQ1AB	1	250		AC 600	J (± 5)	1.0	1.8	±350	E24	Stamp	0.64
2.0						560					
ERQ2Z ERQ2AB	2	250	AC 1000	J (± 5)	1.0	1.8	±350	E24	Stamp	1.54	
2.0					560						

(1) Maximum Open Circuit Voltage: Referring to the maximum value of the voltage applied between terminals of the resistor when the resistor is opened in an electric circuit 1000 times power rating or voltage specified above whichever less is regarded as the maximum open circuit voltage.  
 (2) Rated Continuous Working Voltage (RCWV) shall be determined from  $RCWV = \sqrt{\text{Power Rating} \times \text{Resistance Value}}$

### Power Derating Curve

For resistors operated in ambient temperatures above 70 °C, power rating shall be derated in accordance with the figure on the right.

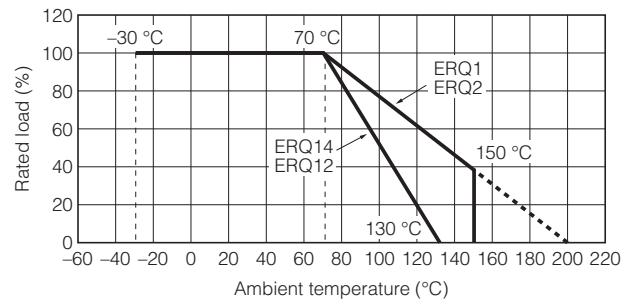

## Performance Specifications

Characteristics	Specifications	Test Methods																
Fusing Characteristics	<table border="1"> <thead> <tr> <th>Rated Power</th> <th>Res. Value (Ω)</th> <th>Limit</th> </tr> </thead> <tbody> <tr> <td>0.25 W 0.5 W</td> <td rowspan="2">1 to 1.8</td> <td>Open within 30 seconds at 30 times the rated power</td> </tr> <tr> <td>1 W 2 W</td> <td>Open within 30 seconds at 25 times the rated power</td> </tr> <tr> <td>0.25 W 0.5 W 1 W 2 W</td> <td>2 to 9.1</td> <td>Open within 30 seconds at 16 times the rated power</td> </tr> <tr> <td>0.25 W</td> <td>10 to 470</td> <td rowspan="3">Open within 30 seconds at 12 times the rated power</td> </tr> <tr> <td>0.5 W 1 W 2 W</td> <td>10 to 560</td> </tr> </tbody> </table>	Rated Power	Res. Value (Ω)	Limit	0.25 W 0.5 W	1 to 1.8	Open within 30 seconds at 30 times the rated power	1 W 2 W	Open within 30 seconds at 25 times the rated power	0.25 W 0.5 W 1 W 2 W	2 to 9.1	Open within 30 seconds at 16 times the rated power	0.25 W	10 to 470	Open within 30 seconds at 12 times the rated power	0.5 W 1 W 2 W	10 to 560	<p>The test potential shall be preadjusted using a dummy resistor and then be subjected to the test specimens. The potential shall be readjusted within two seconds to reach the exact value of specified current. This test shall be made under the conditions at 20 °C and 65 % RH (or at a temperature of 5 °C to 35 °C and 45 to 85 % RH, only when any doubt may not be caused), and the use of stabilized power source is suggested. Fusing time shall be measured as the duration until the circuit current is decreased to a 1/50 the initial test current or less.</p>
	Rated Power	Res. Value (Ω)	Limit															
	0.25 W 0.5 W	1 to 1.8	Open within 30 seconds at 30 times the rated power															
	1 W 2 W		Open within 30 seconds at 25 times the rated power															
	0.25 W 0.5 W 1 W 2 W	2 to 9.1	Open within 30 seconds at 16 times the rated power															
0.25 W	10 to 470	Open within 30 seconds at 12 times the rated power																
0.5 W 1 W 2 W	10 to 560																	

## Dimensions in mm (not to scale)

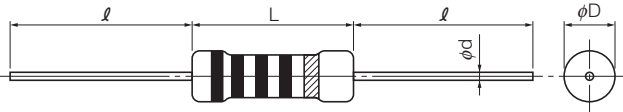

Part No.	Dimensions (mm)			
	L	φD	l	φd
ERQ14	6.3 <sup>+1.5</sup> <sub>-1.0</sub>	2.3 <sup>±0.5</sup>	30.0 <sup>±3.0</sup>	0.65 <sup>±0.05</sup>
ERQ12	9.0 <sup>+1.5</sup> <sub>-1.0</sub>	2.8 <sup>±0.5</sup>	30.0 <sup>±3.0</sup>	0.65 <sup>±0.05</sup>
ERQ1	12.0 <sup>+1.5</sup> <sub>-1.0</sub>	4.0 <sup>±1.0</sup>	30.0 <sup>±3.0</sup>	0.80 <sup>±0.05</sup>
ERQ2	15.0 <sup>±1.5</sup>	5.5 <sup>±1.0</sup>	38.0 <sup>±3.0</sup>	0.80 <sup>±0.05</sup>

## Explanation of Marking

Type ERQ14, ERQ12 (0.25 W, 0.5 W)

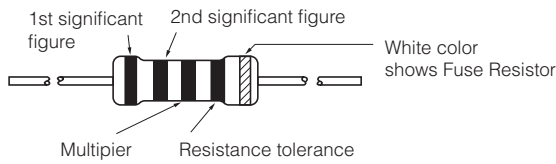

Type ERQ1, ERQ2 (1W, 2W)

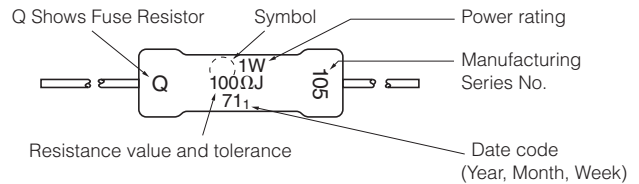

## Cut & Formed Type

ERQ□□AJ□□□P  
ERQ□□ZJ□□□P

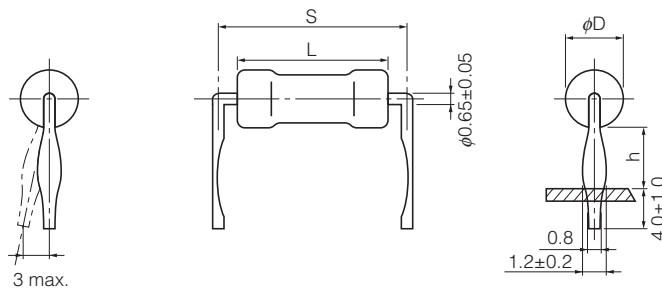

Part No.	Power Rating at 70 °C (W)	Standard Q'ty/Packing (pcs.)	Dimensions (mm)			
			L	φD	S	h
ERQ14□J□□□P	0.25	2,000	6.3 <sup>+1.5</sup> <sub>-1.0</sub>	2.3 <sup>±0.5</sup>	10.0 <sup>±1.5</sup>	4.0 <sup>±1.5</sup>
ERQ12□J□□□P	0.5	2,000	9.0 <sup>+1.5</sup> <sub>-1.0</sub>	2.8 <sup>±0.5</sup>	12.5 <sup>±1.5</sup>	4.0 <sup>±1.5</sup>

ERQ□ABJP□□□S  
ERQ□ZJP□□□S

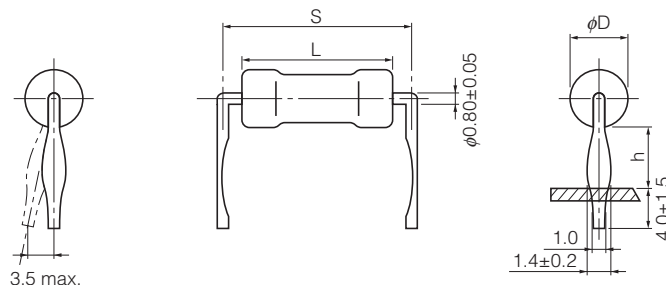

Part No.	Power Rating at 70 °C (W)	Standard Q'ty/Packing (pcs.)	Dimensions (mm)			
			L	φD	S	h
ERQ1□□JP□□□S	1	1,000	12.0 <sup>+1.5</sup> <sub>-1.0</sub>	4.0 <sup>±1.0</sup>	15.0 <sup>±1.5</sup>	6.0 <sup>±1.5</sup>
ERQ2□□JP□□□S	2	1,000	15.0 <sup>±1.5</sup>	5.5 <sup>±1.0</sup>	20.0 <sup>±2.0</sup>	6.5 <sup>±1.5</sup>

Design and specifications are each subject to change without notice. Ask factory for the current technical specifications before purchase and/or use.  
Should a safety concern arise regarding this product, please be sure to contact us immediately.

## For Panasert Automatic Insertion Machine Radial Taped & Box

ERQ□□AJ□□□□E  
ERQ□□ZJ□□□□E  
(14A/14Z, 12A/12Z, 1AB/1Z)

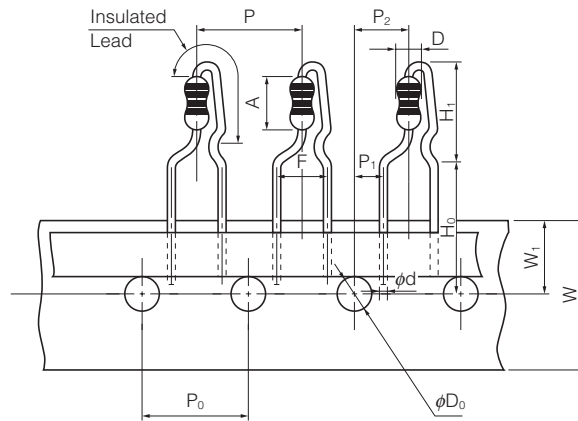

Dimensions (mm)		Dimensions (mm)		Dimensions (mm)		Dimensions (mm)		Dimensions (mm)				
P	12.7±1.0	W	18.0±0.5	H <sub>1</sub>	14A/14Z	12 max.	A	14A/14Z	6.35 <sup>+0.65</sup> <sub>-0.35</sub>	D	14A/14Z	2.3±0.5
P <sub>0</sub>	12.7±0.3	W <sub>1</sub>	9.0±0.5		12A/12Z	15.5 max.		12A/12Z	9.0 <sup>+1.5</sup> <sub>-1.0</sub>		12A/12Z	2.8±0.5
P <sub>1</sub>	3.85±0.70				1AB/1Z	19 max.		1AB/1Z	12.0 <sup>+1.5</sup> <sub>-1.0</sub>		1AB/1Z	4.0±1.0
P <sub>2</sub>	6.35±1.00			H <sub>0</sub>	16.0±0.5		phi d	0.65±0.05				
F	5.0±0.8			phi D <sub>0</sub>	4.0±0.2							

### ● Radial Tape Packaging Methods

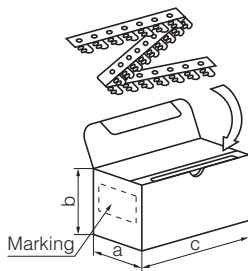

Part Number	Dimensions (mm)			Standard Quantity (pcs./box)
	a	b	c	
ERQ14AJ□□□□E ERQ14ZJ□□□□E	46	130	335	2,000 pcs./box
ERQ12AJ□□□□E ERQ12ZJ□□□□E	46	130	335	2,000 pcs./box
ERQ1ABJ□□□□E ERQ1ZJ□□□□E	49	100	335	1,000 pcs./box

## For Panasert Automatic Insertion Machine Radial Taped & Box

ERQ□□A/ZJW□□□□E (14A/14Z, 12A/12Z, 1AB/1Z)

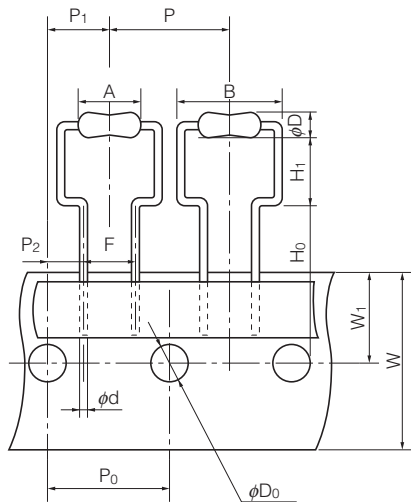

Dimensions (mm)			Dimensions (mm)		
P	14A/14Z	12.7±1.0	H <sub>1</sub>	14A/14Z	6.5 <sup>+0.6</sup> <sub>-0.6</sub>
	12A/12Z, 1AB/1Z	30.0±1.0		12A/12Z	6.5 <sup>+1.0</sup> <sub>-1.0</sub>
P <sub>0</sub>	14A/14Z	12.7±0.3		1AB/1Z	6.5 <sup>+1.0</sup> <sub>-1.0</sub>
	12A/12Z, 1AB/1Z	15.0±0.3	phi D <sub>0</sub>	4.0±0.2	
P <sub>1</sub>	14A/14Z	6.35±1.00	A	14A/14Z	6.35 <sup>+0.65</sup> <sub>-0.35</sub>
	12A/12Z, 1AB/1Z	7.5±1.0		12A/12Z	9.0 <sup>+1.5</sup> <sub>-1.0</sub>
P <sub>2</sub>	14A/14Z	3.85±0.70		1AB/1Z	12.0 <sup>+1.5</sup> <sub>-1.0</sub>
	12A/12Z, 1AB/1Z	3.75±0.50	B	14A/14Z	11.2 max.
F	14A/14Z	5.0 <sup>+0.6</sup> <sub>-0.2</sub>		12A/12Z	14 max.
	12A/12Z, 1AB/1Z	7.5 <sup>+0.6</sup> <sub>-0.2</sub>	1AB/1Z	17 max.	
W	18.0±0.5		phi D	14A/14Z	2.3 <sup>+0.5</sup> <sub>-0.3</sub>
W <sub>1</sub>	9.0±0.5			12A/12Z	2.8±0.5
H <sub>0</sub>	14A/14Z	16.0±0.5	phi d	1AB/1Z	4.0±1.0
	12A/12Z	18.0±1.0		14A/14Z	0.65±0.05
	1AB/1Z	18.0±1.0		12A/12Z, 1AB/1Z	0.80±0.05

## Fusing Characteristics (Constant Voltage Circuit)

This data is for reference only, specifications should be verified in written form with the engineering division.

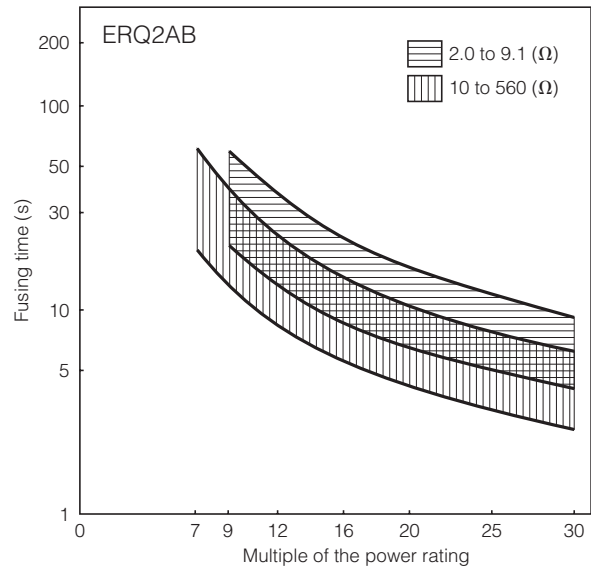
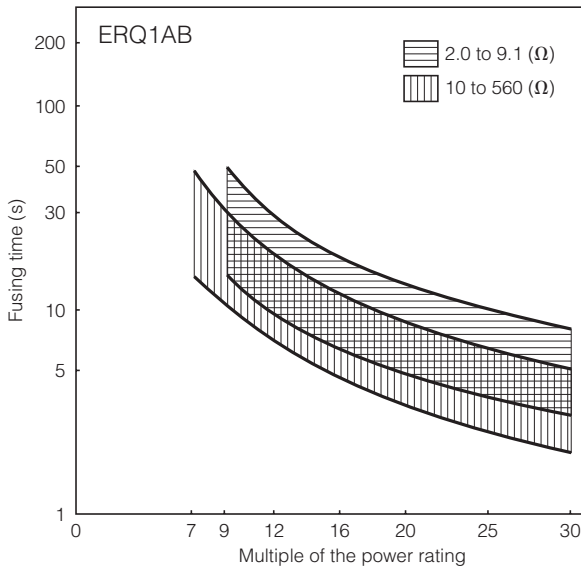
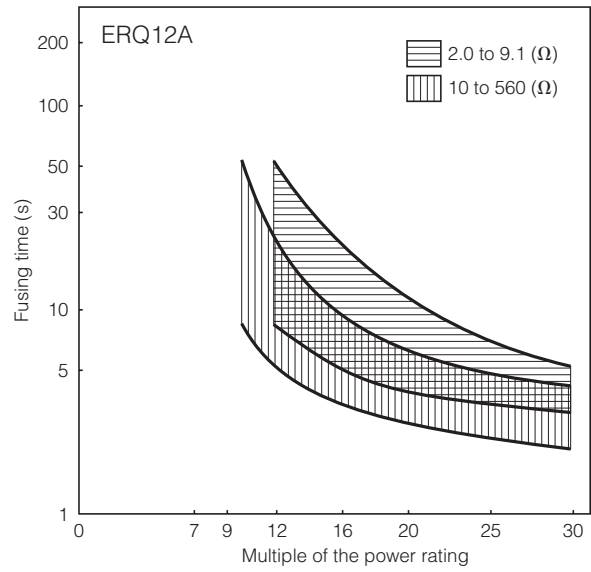
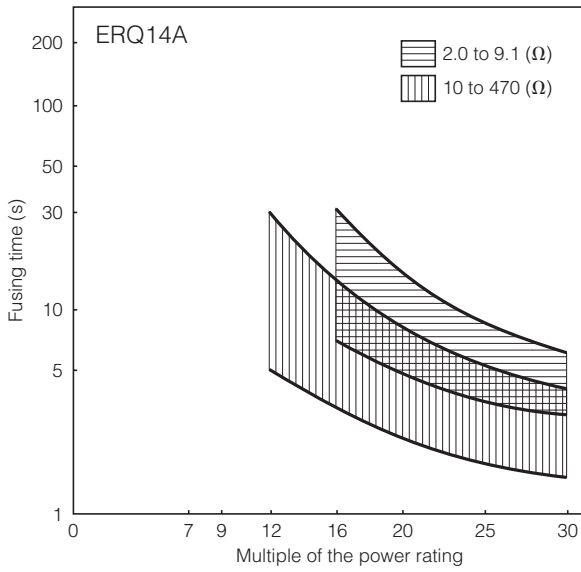

## Hot Spot Temperature (for reference)

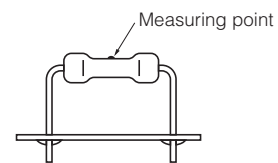
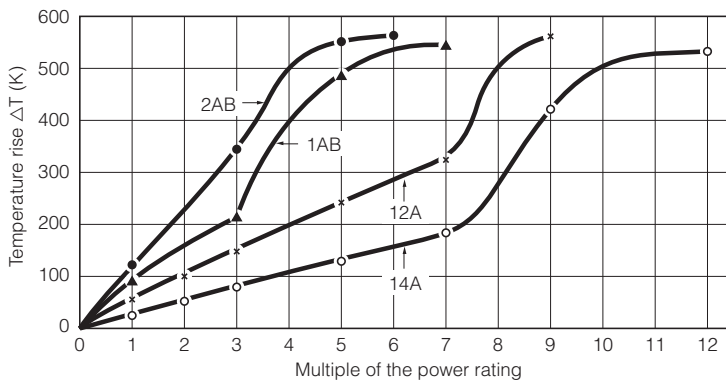

## ⚠ Safety Precautions

The following are precautions for individual products. Please also refer to the common precautions for Fixed Resistors in this catalog.

1. Checking the fusing conditions
  - 1) Fusing characteristics differ depending on the type, shape, and resistance. Check the fusing conditions before selecting the type of Metal Film Fusing Resistors (hereafter called the fusing resistor) to be used.
  - 2) Use the fusing resistors under the maximum open circuit voltage. Otherwise, arcing may occur when a voltage much higher than the rated one is applied in the event of an abnormality in the circuit, or when a high voltage is applied after fusing.
  - 3) Under abnormal conditions of a constant voltage circuit, a current of about 2 or 3 times the initial abnormal current passes through, accelerating the speed at which the fusing resistors blows. When using a constant current circuit, carefully check the conditions because the fusing resistors may not blow in a constant current circuit.
2. Checking for pulse voltage, impact voltage, and transient voltage
 

Make sure to evaluate and check the fusing resistors mounted on your product if they are to be mounted on a circuit that generates an impact voltage, or if there is a possibility that the transient phenomenon (significantly high voltage applied in a short time) may occur or that a pulse voltage with a high peak voltage may be applied. Make sure to consult our sales staff before using the fusing resistors under special conditions.
3. Conditions of use in a steady state
 

Make sure that the load conditions have a sufficient allowance for the power derating curve. The characteristics of the fusing resistors are set by using a constant voltage circuit.
4. The solvent resistance of the fusing resistors is not assured. If you use a solvent for cleaning after soldering or other processes, make sure to consult our sales staff before use and perform a prior test and evaluation to ensure that the solvent will not affect the reliability of the fusing resistors.

## (Data for Reference)

### Pulse Characteristics (Usual)

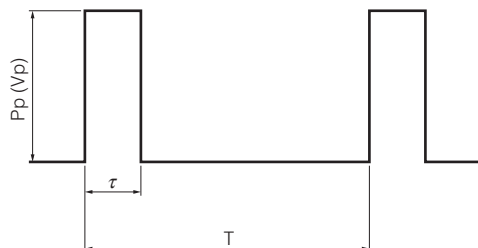

- $P_P$  : Pulse limit power (W)
- $V_P$  : Pulse limit voltage (V)
- $\tau$  : Pulse continuous time (s)
- $T$  : Period (s)
- $V_R$  : Rated voltage (V)
- $P$  : Rated power (W)
- $R$  : Resistance value ( $\Omega$ )
- $V_{pmax.}$  : Max. pulse limit voltage (V)

Withstand pulse limit power is calculated by the next method.

$$P_P = K \cdot P \cdot T / \tau$$

$$V_P = \sqrt{K \cdot P \cdot R \cdot T / \tau}$$

Reference to the right about a fixed number of  $V_{pmax.}$

Part No.	K	$V_{pmax.}$ (V)
ERQ14A	0.6	200
ERQ12A	0.6	250
ERQ1AB	0.6	250
ERQ2AB	0.4	250

- $T > 1(s) \rightarrow T = 1(s)$
- $T / \tau > 100 \rightarrow T / \tau = 100$
- $P_P < P \rightarrow P$  stands for  $P_P$   
( $V_P < V_R \rightarrow V_R$  stands for  $V_P$ )
- Added voltage  $\leq V_{pmax.}$
- $P_P$  or  $V_P$  is reference value  
Conditions : Pulse added time=1000 h, Resistance change= $\pm 5\%$   
Room temperature

## ⚠ Safety Precautions (Common precautions for Fixed Resistors)

- When using our products, no matter what sort of equipment they might be used for, be sure to make a written agreement on the specifications with us in advance. The design and specifications in this catalog are subject to change without prior notice.
- Do not use the products beyond the specifications described in this catalog.
- This catalog explains the quality and performance of the products as individual components. Before use, check and evaluate their operations when installed in your products.
- Install the following systems for a failsafe design to ensure safety if these products are to be used in equipment where a defect in these products may cause the loss of human life or other significant damage, such as damage to vehicles (automobile, train, vessel), traffic lights, medical equipment, aerospace equipment, electric heating appliances, combustion/gas equipment, rotating equipment, and disaster/crime prevention equipment.
- \* Systems equipped with a protection circuit and a protection device
- \* Systems equipped with a redundant circuit or other system to prevent an unsafe status in the event of a single fault

### (1) Precautions for use

- These products are designed and manufactured for general and standard use in general electronic equipment (e.g. AV equipment, home electric appliances, office equipment, information and communication equipment)
- These products are not intended for use in the following special conditions. Before using the products, carefully check the effects on their quality and performance, and determine whether or not they can be used.
  1. In liquid, such as water, oil, chemicals, or organic solvent
  2. In direct sunlight, outdoors, or in dust
  3. In salty air or air with a high concentration of corrosive gas, such as Cl<sub>2</sub>, H<sub>2</sub>S, NH<sub>3</sub>, SO<sub>2</sub>, or NO<sub>2</sub>
  4. Electric Static Discharge (ESD) Environment  
These components are sensitive to static electricity and can be damaged under static shock (ESD). Please take measures to avoid any of these environments.  
Smaller components are more sensitive to ESD environment.
  5. Electromagnetic Environment  
Avoid any environment where strong electromagnetic waves exist.
  6. In an environment where these products cause dew condensation
  7. Sealing or coating of these products or a printed circuit board on which these products are mounted, with resin or other materials
- These products generate Joule heat when energized. Carefully position these products so that their heat will not affect the other components.
- Carefully position these products so that their temperatures will not exceed the category temperature range due to the effects of neighboring heat-generating components. Do not mount or place heat-generating components or inflammables, such as vinyl-coated wires, near these products.
- Note that non-cleaning solder, halogen-based highly active flux, or water-soluble flux may deteriorate the performance or reliability of the products.
- Carefully select a flux cleaning agent for use after soldering. An unsuitable agent may deteriorate the performance or reliability. In particular, when using water or a water-soluble cleaning agent, be careful not to leave water residues. Otherwise, the insulation performance may be deteriorated.

### (2) Precautions for storage

The performance of these products, including the solderability, is guaranteed for a year from the date of arrival at your company, provided that they remain packed as they were when delivered and stored at a temperature of 5 °C to 35 °C and a relative humidity of 45 % to 85 %.

Even within the above guarantee periods, do not store these products in the following conditions. Otherwise, their electrical performance and/or solderability may be deteriorated, and the packaging materials (e.g. taping materials) may be deformed or deteriorated, resulting in mounting failures.

1. In salty air or in air with a high concentration of corrosive gas, such as Cl<sub>2</sub>, H<sub>2</sub>S, NH<sub>3</sub>, SO<sub>2</sub>, or NO<sub>2</sub>
2. In direct sunlight

### <Package markings>

Package markings include the product number, quantity, and country of origin. In principle, the country of origin should be indicated in English.

## Guidelines and precautions regarding the technical information and use of our products described in this online catalog.

- If you want to use our products described in this online catalog for applications requiring special qualities or reliability, or for applications where the failure or malfunction of the products may directly jeopardize human life or potentially cause personal injury (e.g. aircraft and aerospace equipment, traffic and transportation equipment, combustion equipment, medical equipment, accident prevention, anti-crime equipment, and/or safety equipment), it is necessary to verify whether the specifications of our products fit to such applications. Please ensure that you will ask and check with our inquiry desk as to whether the specifications of our products fit to such applications use before you use our products.
- The quality and performance of our products as described in this online catalog only apply to our products when used in isolation. Therefore, please ensure you evaluate and verify our products under the specific circumstances in which our products are assembled in your own products and in which our products will actually be used.
- If you use our products in equipment that requires a high degree of reliability, regardless of the application, it is recommended that you set up protection circuits and redundancy circuits in order to ensure safety of your equipment.
- The products and product specifications described in this online catalog are subject to change for improvement without prior notice. Therefore, please be sure to request and confirm the latest product specifications which explain the specifications of our products in detail, before you finalize the design of your applications, purchase, or use our products.
- The technical information in this online catalog provides examples of our products' typical operations and application circuits. We do not guarantee the non-infringement of third party's intellectual property rights and we do not grant any license, right, or interest in our intellectual property.
- If any of our products, product specifications and/or technical information in this online catalog is to be exported or provided to non-residents, the laws and regulations of the exporting country, especially with regard to security and export control, shall be observed.

## <Regarding the Certificate of Compliance with the EU RoHS Directive/REACH Regulations>

- The switchover date for compliance with the RoHS Directive/REACH Regulations varies depending on the part number or series of our products.
- When you use the inventory of our products for which it is unclear whether those products are compliant with the RoHS Directive/REACH Regulation, please select "Sales Inquiry" in the website inquiry form and contact us.

**We do not take any responsibility for the use of our products outside the scope of the specifications, descriptions, guidelines and precautions described in this online catalog.**