

## Surface Mount Type

Series : Medium-size **TK** Type : **V**  
**High temperature**  
**Lead-Free reflow (suffix : A\*)**



### Features

- Endurance : 125 °C 2000 h
- Vibration-proof product is available upon request.
- RoHS compliant

### Specifications

Category temperature range	-40 °C to +125 °C								
Rated voltage range	10 V.DC to 100 V.DC								
Capacitance range	47 μF to 4700 μF								
Capacitance tolerance	±20 % (120 Hz/+20 °C)								
Leakage current	I ≤ 0.01 CV After 2 minutes								
Dissipation factor (tan δ)	Please see the attached characteristics list								
Characteristics at low temperature	V.DC	10	16	25	35	50	63	80	100
	Z(-25 °C)/Z(+20 °C)	3	2	2	2	2	2	2	2
	Z(-40 °C)/Z(+20 °C)	6	4	4	3	3	3	3	3

(Impedance ratio at 120 Hz)

Endurance	After applying rated working voltage for 2000 hours at +125 °C±2 °C and then being stabilized at +20 °C, Capacitors shall meet the following limits.	
	Capacitance change	Within ±30 % of the initial value (Miniaturization product : Within ±35 %)
	tan δ	≤300 % of the initial limit (Miniaturization product : Within 350 %)
Shelf life	After storage for 1000 hours at +125 °C±2 °C with no voltage applied and then being stabilized at +20 °C, capacitors shall meet the limits specified in Endurance.(With voltage treatment)	
	After reflow soldering and then being stabilized at +20 °C, capacitors shall meet the following limits.	
Resistance to soldering heat	Capacitance change	Within ±10 % of the initial value
	tan δ	Within the initial limit
	DC leakage current	Within the initial limit
AEC-Q200	AEC-Q200 compliant	

### Frequency correction factor for ripple current

Frequency (Hz)	120	1 k	10 k	100 k to
Correction factor	0.75	0.90	0.95	1.00

### Marking

Example : 10 V.DC 1000 μF  
 Marking color : BLACK

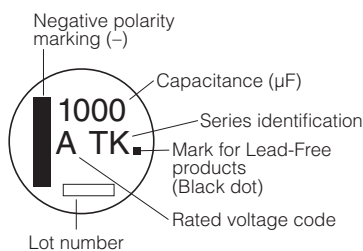

R. Voltage (V.DC)	10	16	25	35	50	63	80	100
Code	A	C	E	V	H	J	K	2A

### Dimensions

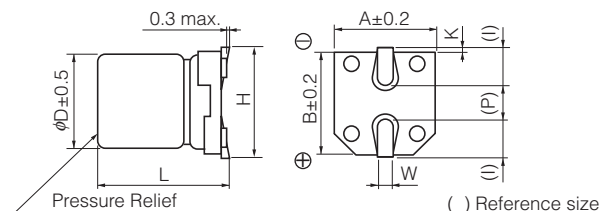

(Unit : mm)

Size code	φD	L	A, B	H	I	W	P	K
H13	12.5	13.5±0.5	13.5	15.0 max.	4.7	0.90±0.3	4.4	0.70±0.3
J16	16.0	16.5±0.5	17.0	19.0 max.	5.5	1.20±0.3	6.7	0.70±0.3
K16	18.0	16.5±0.5	19.0	21.0 max.	6.7	1.20±0.3	6.7	0.70±0.3

### Dimensions (Vibration-proof products)

\* The size and shape are different from standard products. Please inquire details of our company.

< Size code : D, D8 >

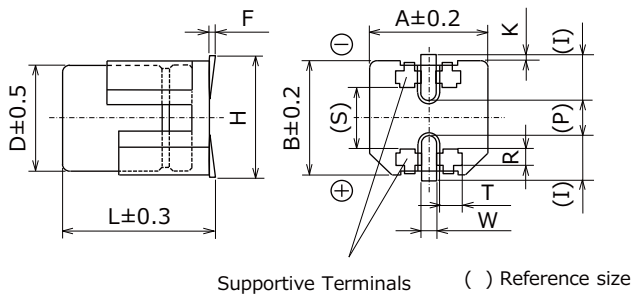

< Size code : E, F, G, H13, J16, K16, K21 >

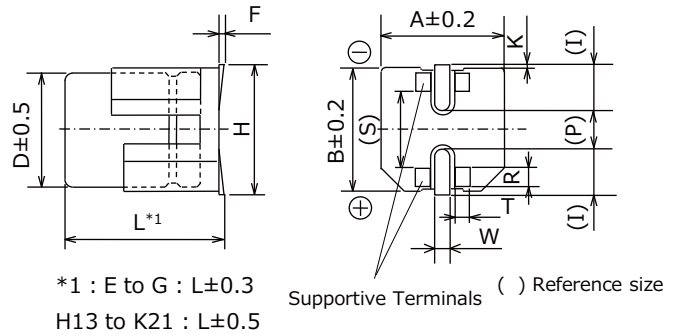

\*1 : E to G : L±0.3  
H13 to K21 : L±0.5

Unit : mm

Size code	φD	L	A, B	H max.	F	I	W	P	K	R	S	T
D	6.3	6.1	6.6	7.8	0 to +0.15	2.4	0.65±0.1	2.2	0.35 <sup>+0.15</sup> <sub>-0.20</sub>	1.1±0.2	3.3±0.2	1.05±0.2
D8	6.3	8.0	6.6	7.8	0 to +0.15	2.4	0.65±0.1	2.2	0.35 <sup>+0.15</sup> <sub>-0.20</sub>	1.1±0.2	3.3±0.2	1.05±0.2
E	8.0	6.5	8.3	9.5	0 to +0.15	3.4	0.7±0.1	2.2	0.35 <sup>+0.15</sup> <sub>-0.20</sub>	0.70±0.2	5.3±0.2	1.7±0.2
F	8.0	10.5	8.3	10.0	0 to +0.15	3.4	1.2±0.2	3.1	0.70±0.2	0.70±0.2	5.3±0.2	1.3±0.2
G	10.0	10.5	10.3	12.0	0 to +0.15	3.5	1.2±0.2	4.6	0.70±0.2	0.70±0.2	6.9±0.2	1.3±0.2
H13	12.5	13.8	13.5	15.0	-0.1 to +0.15	4.7	1.2±0.2	4.4	0.70±0.3	2.2±0.2	7.1±0.2	2.4±0.2
J16	16.0	16.8	17.0	19.0	-0.1 to +0.15	5.5	1.4±0.2	6.7	0.70±0.3	3.0±0.2	9.0±0.2	1.9±0.2
K16	18.0	16.8	19.0	21.0	-0.1 to +0.15	6.7	1.4±0.2	6.7	0.70±0.3	3.0±0.2	11.0±0.2	1.9±0.2
K21	18.0	21.8	19.0	21.0	-0.1 to +0.15	6.7	1.4±0.2	6.7	0.70±0.3	3.0±0.2	11.0±0.2	1.9±0.2

### Land / Pad pattern

The circuit board land/pad pattern size for chip capacitors is specified in the following table. The land pitch influences installation strength and consider it.

#### ● Standard products

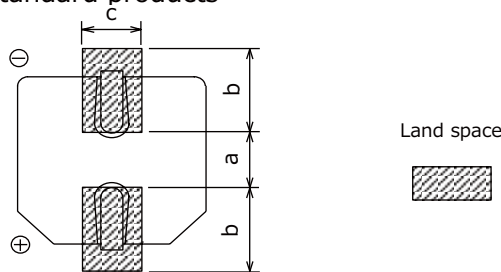

(Table of board land size vs. capacitor size)

Size code	a	b	c
B (φ4)	1.0	2.5	1.6
C (φ5)	1.5	2.8	1.6
D (φ6.3)	1.8	3.2	1.6
D8 (φ6.3x7.7L)	1.8	3.2	1.6
E (φ8x6.2L)	2.2	4.0	1.6
F (φ8x10.2L)	3.1	4.0	2.0
G (φ10x10.2L)	4.6	4.1	2.0
H (φ12.5)	4.0	5.7	2.0
J (φ16)	6.0	6.5	2.5
K (φ18)	6.0	7.5	2.5

Unit : mm

When size "a" is wide, back fillet can be made, decreasing fitting strength.

#### ● Vibration-proof products

< Size code : D, D8 >

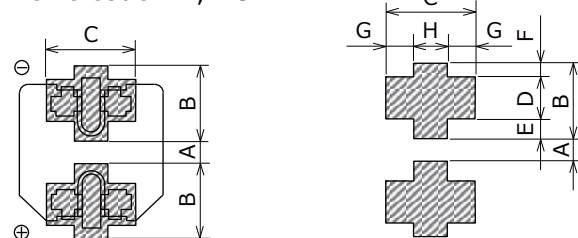

(Table of board land size vs. capacitor size)

Size code	A	B	C	D	E	F	G	H
D (φ6.3xL6.1)	1.2	3.6	3.2	2.0	0.95	0.65	1.0	1.2
D8 (φ6.3xL8.0)	1.2	3.6	3.2	2.0	0.95	0.65	1.0	1.2
E (φ8x6.5L)	1.8	4.2	5.0	1.3	1.5	1.4	1.5	2.0
F (φ8x10.5L)	2.7	4.0	4.7	1.3	1.0	1.7	1.1	2.5
G (φ10)	3.9	4.4	4.7	1.3	1.2	1.9	1.1	2.5
H (φ12.5)	3.9	6.0	6.9	2.8	1.3	1.9	2.2	2.5
J (φ16)	5.8	6.8	6.2	3.6	1.3	1.9	1.7	2.8
K (φ18)	5.8	7.3	6.2	3.6	1.8	1.9	1.7	2.8

Unit : mm

When size "A" is wide, back fillet can be made, decreasing fitting strength.

< Size code : E, F, G, H, J, K >

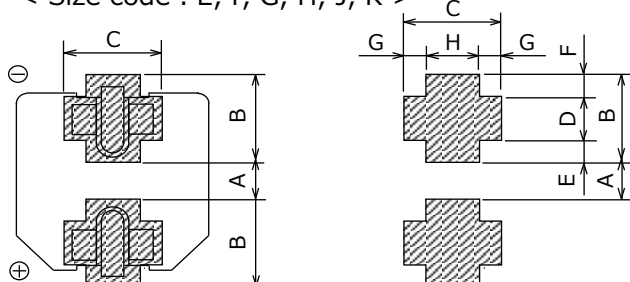

\* Take mounting conditions, solderability and fitting strength into consideration when selecting parts for your company's design.

\* The vibration-proof capacitors of size φ6.3 has support terminals extending from the bottom side to the lead edge. Then, make sure to find appropriate soldering conditions to form fillet on the support terminals if required for appearance inspection.

## Characteristics list

Endurance : 125 °C 2000 h

Rated voltage (V.DC)	Cap. (±20 %) (μF)	Case size (mm)		Size* code	Specification			Part No.	Reflow	Min. Packaging Qty	
		φD	L		Ripple current (100 kHz) (+125 °C) (mA r.m.s.)	ESR (100 kHz) (Ω)				tan δ (120 Hz) (+20 °C)	Taping (pcs)
						+20 °C	-40 °C				
10	1000	12.5	13.5	H13	800	0.120	1.80	0.30	EEETK1A102AQ	(9)	200
	1500	12.5	13.5	(H13)	800	0.120	1.80	0.30	EEETKA152UAQ	(9)	200
	2200	16	16.5	J16	1100	0.080	1.20	0.32	EEETK1A222AM	(9)	125
	3300	16	16.5	(J16)	1100	0.080	1.20	0.34	EEETKA332UAM	(9)	125
		18	16.5	K16	1300	0.075	1.10	0.36	EEETK1A332AM	(9)	125
	4700	18	16.5	K16	1300	0.075	1.10	0.38	EEETK1A472AM	(9)	125
16	330	12.5	13.5	H13	800	0.120	1.80	0.23	EEETK1C331AQ	(9)	200
	470	12.5	13.5	H13	800	0.120	1.80	0.23	EEETK1C471AQ	(9)	200
	680	12.5	13.5	H13	800	0.120	1.80	0.23	EEETK1C681AQ	(9)	200
	1000	12.5	13.5	(H13)	800	0.120	1.80	0.23	EEETKC102UAQ	(9)	200
		16	16.5	J16	1100	0.080	1.20	0.25	EEETK1C102AM	(9)	125
	2200	16	16.5	(J16)	1100	0.080	1.20	0.27	EEETKC222UAM	(9)	125
		18	16.5	K16	1300	0.075	1.10	0.27	EEETK1C222AM	(9)	125
3300	18	16.5	K16	1300	0.075	1.10	0.29	EEETK1C332AM	(9)	125	
25	330	12.5	13.5	H13	800	0.120	1.80	0.18	EEETK1E331AQ	(9)	200
	470	12.5	13.5	H13	800	0.120	1.80	0.18	EEETK1E471AQ	(9)	200
	680	12.5	13.5	(H13)	800	0.120	1.80	0.18	EEETKE681UAQ	(9)	200
		16	16.5	J16	1100	0.080	1.20	0.18	EEETK1E681AM	(9)	125
	1000	16	16.5	(J16)	1100	0.080	1.20	0.18	EEETKE102UAM	(9)	125
		18	16.5	K16	1300	0.075	1.10	0.18	EEETK1E102AM	(9)	125
	2200	18	16.5	K16	1300	0.075	1.10	0.20	EEETK1E222AM	(9)	125
35	330	12.5	13.5	H13	800	0.120	1.80	0.16	EEETK1V331AQ	(9)	200
	470	12.5	13.5	(H13)	800	0.120	1.80	0.16	EEETKV471UAQ	(9)	200
		16	16.5	J16	1100	0.080	1.20	0.16	EEETK1V471AM	(9)	125
	680	16	16.5	(J16)	1100	0.080	1.20	0.16	EEETKV681UAM	(9)	125
		18	16.5	K16	1300	0.075	1.10	0.16	EEETK1V681AM	(9)	125
	1000	18	16.5	K16	1300	0.075	1.10	0.16	EEETK1V102AM	(9)	125
50	220	12.5	13.5	H13	600	0.230	3.40	0.14	EEETK1H221AQ	(10)	200
	330	12.5	13.5	H13	600	0.230	3.40	0.14	EEETK1H331AQ	(10)	200
	470	16	16.5	J16	900	0.150	2.20	0.14	EEETK1H471AM	(10)	125
		16	16.5	(J16)	900	0.150	2.20	0.14	EEETKH681UAM	(10)	125
	680	18	16.5	K16	950	0.140	2.10	0.14	EEETK1H681AM	(10)	125
		1000	18	16.5	K16	950	0.140	2.10	0.14	EEETK1H102AM	(10)
63	100	12.5	13.5	H13	350	0.260	5.20	0.12	EEETK1J101AQ	(11)	200
	220	12.5	13.5	H13	350	0.260	5.20	0.12	EEETK1J221AQ	(11)	200
	330	16	16.5	J16	500	0.180	3.60	0.12	EEETK1J331AM	(11)	125
	470	16	16.5	J16	500	0.180	3.60	0.12	EEETK1J471AM	(11)	125
80	47	12.5	13.5	H13	250	0.420	8.40	0.12	EEETK1K470AQ	(11)	200
	100	12.5	13.5	(H13)	250	0.420	8.40	0.12	EEETKK101UAQ	(11)	200
		16	16.5	J16	350	0.300	6.00	0.12	EEETK1K101AM	(11)	125
	220	16	16.5	(J16)	350	0.300	6.00	0.12	EEETKK221UAM	(11)	125
		18	16.5	K16	400	0.280	5.60	0.12	EEETK1K221AM	(11)	125
	330	16	16.5	(J16)	350	0.300	6.00	0.12	EEETKK331UAM	(11)	125
		18	16.5	K16	400	0.280	5.60	0.12	EEETK1K331AM	(11)	125
470	18	16.5	K16	400	0.280	5.60	0.12	EEETK1K471AM	(11)	125	
100	47	12.5	13.5	H13	250	0.420	8.40	0.10	EEETK2A470AQ	(11)	200
	100	16	16.5	J16	350	0.300	6.00	0.10	EEETK2A101AM	(11)	125
	220	18	16.5	K16	400	0.280	5.60	0.10	EEETK2A221AM	(11)	125
	330	18	16.5	K16	400	0.280	5.60	0.10	EEETK2A331AM	(11)	125

- \* Size code( ) : Miniaturization product
- Please refer to the page of "Reflow Profile" and "The Taping Dimensions".
- When requesting vibration-proof product, please put the last "V" instead to "Q" or "M"

## Guidelines and precautions regarding the technical information and use of our products described in this online catalog.

- If you want to use our products described in this online catalog for applications requiring special qualities or reliability, or for applications where the failure or malfunction of the products may directly jeopardize human life or potentially cause personal injury (e.g. aircraft and aerospace equipment, traffic and transportation equipment, combustion equipment, medical equipment, accident prevention, anti-crime equipment, and/or safety equipment), it is necessary to verify whether the specifications of our products fit to such applications. Please ensure that you will ask and check with our inquiry desk as to whether the specifications of our products fit to such applications use before you use our products.
- The quality and performance of our products as described in this online catalog only apply to our products when used in isolation. Therefore, please ensure you evaluate and verify our products under the specific circumstances in which our products are assembled in your own products and in which our products will actually be used.
- If you use our products in equipment that requires a high degree of reliability, regardless of the application, it is recommended that you set up protection circuits and redundancy circuits in order to ensure safety of your equipment.
- The products and product specifications described in this online catalog are subject to change for improvement without prior notice. Therefore, please be sure to request and confirm the latest product specifications which explain the specifications of our products in detail, before you finalize the design of your applications, purchase, or use our products.
- The technical information in this online catalog provides examples of our products' typical operations and application circuits. We do not guarantee the non-infringement of third party's intellectual property rights and we do not grant any license, right, or interest in our intellectual property.
- If any of our products, product specifications and/or technical information in this online catalog is to be exported or provided to non-residents, the laws and regulations of the exporting country, especially with regard to security and export control, shall be observed.

## <Regarding the Certificate of Compliance with the EU RoHS Directive/REACH Regulations>

- The switchover date for compliance with the RoHS Directive/REACH Regulations varies depending on the part number or series of our products.
- When you use the inventory of our products for which it is unclear whether those products are compliant with the RoHS Directive/REACH Regulation, please select "Sales Inquiry" in the website inquiry form and contact us.

**We do not take any responsibility for the use of our products outside the scope of the specifications, descriptions, guidelines and precautions described in this online catalog.**

---