

Product Overview

The AG201-63G is a general-purpose buffer amplifier that offers high dynamic range operation in a low-cost surface mount package. At 900 MHz, the AG201-63G provides typical 11 dB of gain, +19 dBm OIP3 and +6.5 dBm P1dB. This device combines dependable performance with consistent quality to maintain MTTF values exceeding 1000 years at mounting temperatures of +85°C. The device is housed in a lead-free/Green/RoHS-compliant SOT-363 industry standards SMT package.

The AG201-63G consists of a Darlington-pair amplifier using the high reliability InGap/GaAs HBT process technology and only requires DC-blocking capacitors, a bias resistor, and an inductive RF choke for operation.

This broadband MMIC amplifier can be directly applied to various current and next generation wireless technologies such as GPRS, GSM, CDMA, and WCDMA. In addition, The AG201-63G will work for other various applications within the DC to 6 GHz frequency range such as CATV and WiMAX.



SoT-636 Package

Key Features

- DC – 6000 MHz
- 11 dB Gain at 900 MHz
- +6.5 dBm P1dB at 900 MHz
- +19 dBm OIP3 at 900 MHz
- Single Voltage Supply
- Internal Matched to 50 Ω
- Robust 1000V ESD, Class 1C
- Lead-free / Green / RoHS Compliant SoT-636 Package

Functional Block Diagram

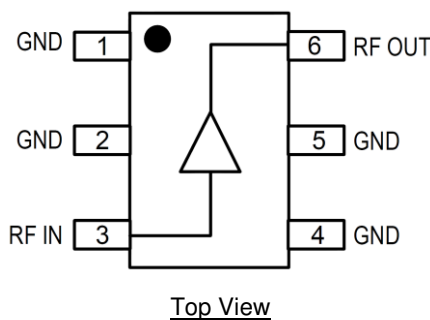

Pin Configuration

Pin No.	Function
3	RF Input
6	RF Output
1, 2, 4, 5	Ground

Applications

- Mobile Infrastructure
- CATV / FTTH
- WLAN / ISM
- RFID
- WiMAX / WiBro

Ordering Information

Part No.	Description
AG201-63G	3,000 pieces on a 7" reel
AG201-63 PCB	700–2400 MHz Evaluation Board

Absolute Maximum Ratings

Parameter	Rating
Storage Temperature	-55 to +125 °C
Operational Temperature	-55 to +105 °C
Device DC Voltage	+4.5 V
RF Input Power (continuous)	+10 dBm

Exceeding any one or a combination of the Absolute Maximum Rating conditions may cause permanent damage to the device. Extended application of Absolute Maximum Rating conditions to the device may reduce device reliability.

Recommended Operating Conditions

Parameter	Min	Typ	Max	Units
Device Voltage (V_{DEVICE})		+4		V
Device Current (I_{CC})		20		mA
T_{CASE}	-40		+105	°C
T_j for $>10^6$ hours MTTF			+177	°C

Electrical specifications are measured at specified test conditions. Specifications are not guaranteed over all recommended operating conditions.

Electrical Specifications

Parameter	Conditions ⁽¹⁾	Min	Typ	Max	Units
Operational Frequency Range		DC		6000	MHz
Test Frequency			900		MHz
Gain			11.3		dB
Input Return Loss			25		dB
Output Return Loss			16		dB
Output P1dB			+6.5		dBm
Output IP3	$P_{out} = -10$ dBm/tone, $\Delta f = 10$ MHz		+19.1		dBm
Output IP2			+27		dBm
Noise Figure			4.4		dB
Test Frequency			1900		MHz
Gain		10	11	12	dB
Output P1dB			+5.8		dBm
Output IP3	$P_{out} = -10$ dBm/tone, $\Delta f = 10$ MHz		+18.5		dBm
Device Voltage			+4		V
Device Current			20		mA
Thermal Resistance, θ_{jc}	Junction to case			410	°C/W

Notes:

1. Test conditions unless otherwise noted: Supply Voltage = +5.0 V, $R_{BIAS} = 49.9 \Omega$, Temp = +25 °C, 50 Ω system.

S-Parameters

Freq (GHz)	S11 (dB)	S11 (ang)	S21 (dB)	S21 (ang)	S12 (dB)	S12 (ang)	S22 (dB)	S22 (ang)
50	-33.36	-6.60	11.22	178.53	-16.01	1.78	-16.22	-2.50
250	-34.27	26.40	11.19	172.86	-16.41	0.49	-16.31	-4.04
500	-33.08	106.48	11.19	165.72	-16.39	-3.56	-18.46	-10.33
750	-29.63	86.10	11.15	158.59	-16.32	-5.87	-18.71	-19.75
1000	-26.66	74.33	11.07	151.65	-16.67	-10.07	-19.20	-28.63
1250	-24.09	69.64	11.04	144.43	-16.23	-10.28	-19.49	-42.62
1500	-22.36	64.19	10.96	137.42	-16.24	-11.70	-19.55	-55.66
1750	-20.94	60.32	10.88	130.39	-16.37	-13.92	-19.24	-69.54
2000	-19.57	56.83	10.77	123.52	-16.33	-14.76	-19.04	-82.66
2250	-16.29	43.02	10.61	116.95	-16.37	-17.48	-15.52	-85.89
2500	-16.47	38.44	10.54	112.28	-16.76	-23.47	-16.44	-94.20
2750	-16.81	41.05	10.48	105.22	-16.16	-23.54	-17.38	-103.52
3000	-17.52	42.18	10.38	98.63	-16.10	-23.33	-19.06	-113.34
3250	-18.18	45.78	10.31	92.38	-16.25	-24.50	-21.18	-127.55
3500	-18.21	48.49	10.24	85.82	-16.21	-26.42	-23.63	-155.61
3750	-18.11	50.97	10.08	79.13	-15.99	-29.08	-23.62	163.87
4000	-17.38	54.83	9.98	72.24	-16.06	-32.03	-21.23	140.39
4250	-16.85	56.42	9.83	65.64	-15.97	-34.05	-18.49	125.84
4500	-16.39	56.13	9.67	59.19	-15.80	-36.44	-16.69	120.27
4750	-16.25	53.66	9.51	52.37	-15.80	-38.98	-15.54	116.28
5000	-16.06	51.28	9.39	45.85	-15.85	-42.28	-14.43	116.89
5250	-17.05	44.99	9.23	39.74	-15.85	-44.47	-14.46	117.24
5500	-18.24	33.18	9.07	33.99	-15.76	-45.79	-14.46	117.59
5750	-19.96	22.01	9.03	27.96	-15.43	-49.07	-14.85	122.56
6000	-21.05	8.45	8.95	21.94	-15.61	-50.71	-14.99	122.55

Test Conditions: $V_{\text{DEVICE}} = +5 \text{ V}$, $I_{\text{CC}} = 20 \text{ mA (typ.)}$, $\text{Temp.} = +25^\circ\text{C}$, reference plane at device leads

700–2400 MHz Evaluation Board – AG201-63 PCB

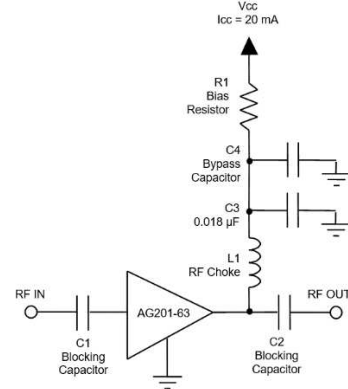
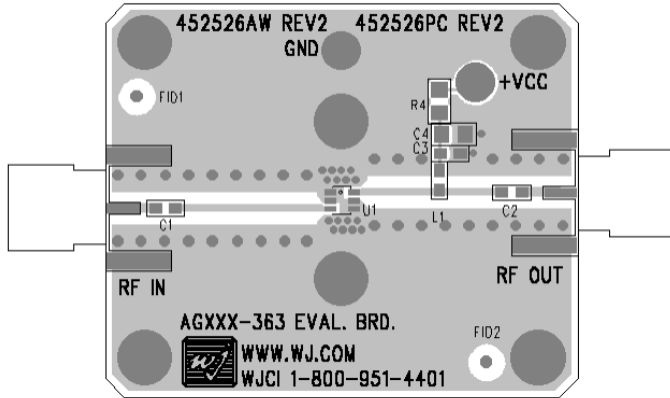

Bill of Material – AG201-63 PCB

Reference Des.	Value	Description	Manuf.	Part Number
PCB		Printed Circuit Board	Qorvo	
U1		Amplifier, InGaP GaAs HBT	Qorvo	AG201-63G
C1, C2	56 pF	Capacitor, 56 pF, 5%, 50V, C0G, 0603	various	
C3	0.018 µF	Capacitor, 0.018 µF, 50V, X7R, 0603		
L1	39 nH	Inductor, 39 nH, 5%, Wire wound, 0603	various	
R1	49.9 Ω	Resistor, 49.9 Ω, 1%, 1/16W, 0603	various	

Note: see Component Values table for Optimum performance in specific frequency bands

Component Values for Specific Frequencies and Supply Voltages

Frequency (MHz)	50	500	900	1900	2200	2500	3500
L1	820 nH	220 nH	68 nH	27 nH	22 nH	18 nH	15 nH
C1, C2, C4	.018 µF	1000 pF	100 pF	68 pF	68 pF	56 pF	39 pF
V _{SUPPLY} (V)	5	6	7	8	9	10	12
R1 (Ω)	50	100	150	200	250	300	400
Component Size	0603	0603	0805	0805	1206	1210	1210

Typical Performance – AG201-63G

Parameter	Typical Performance Value ⁽¹⁾								Units
	100	500	900	1900	2140	2400	3500	5800	
Frequency	100	500	900	1900	2140	2400	3500	5800	MHz
Gain	11.4	11.4	11.3	11.0	10.9	10.8	10.4	9.2	dB
Input Return Loss	-30	-30	-25	-20	-15	-16	-18	-20	dB
Output Return Loss	-16	-16	-16	-16	-16	-16	-20	-14	dB
Output P1dB	+6.5	+6.5	+6.5	+5.8	+5.1	+5.0	+4.1		dBm
OIP3 ⁽²⁾	+19.5	+19.5	+19.1	+18.5	+18.2	+17.7			dBm
Noise Figure	4.3	4.3	4.4	4.6	4.6	4.7			dB

Notes:

1. Test conditions unless otherwise noted: Supply Voltage = +5V, V_{DEVICE} = +4V, R_{bias} = 49.9 Ω, I_{CC} = 20 mA, Temp. = +25 °C
2. P_{out} = -10 dBm/tone, Δf = 10 MHz

Performance Plots – AG201-63G PCB

Test conditions unless otherwise noted: Supply Voltage = +5 V, I_{CC} = 20 mA, R_{BIAS} = 49.9 Ω, Temp.=+25 °C

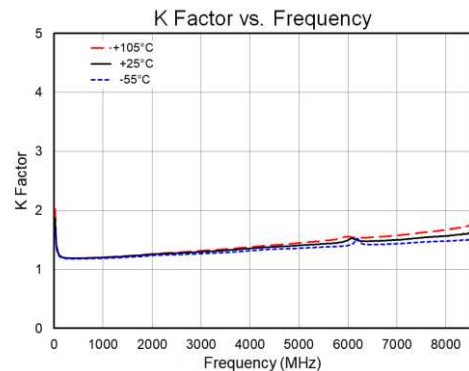
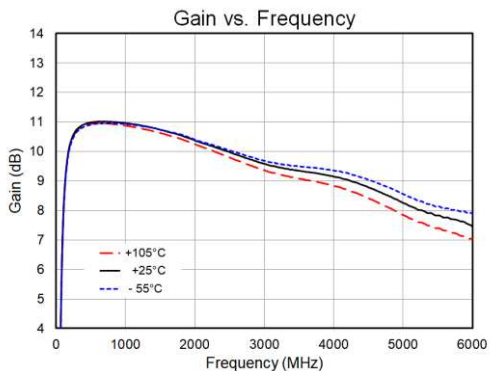
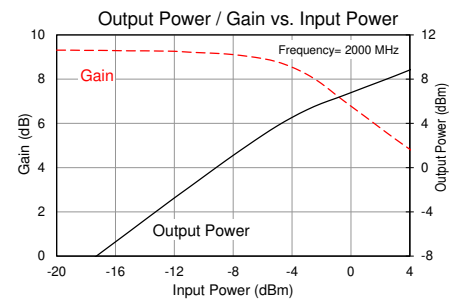
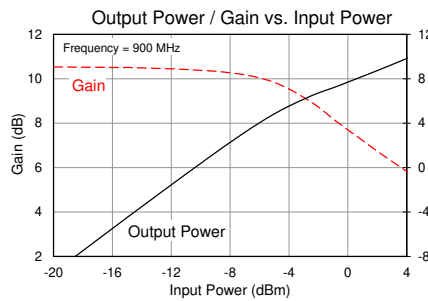
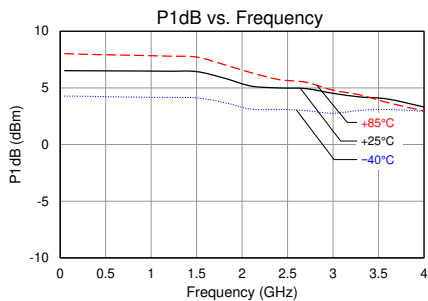
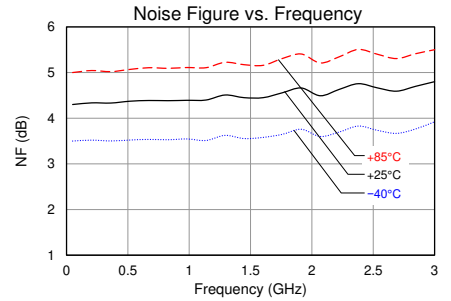
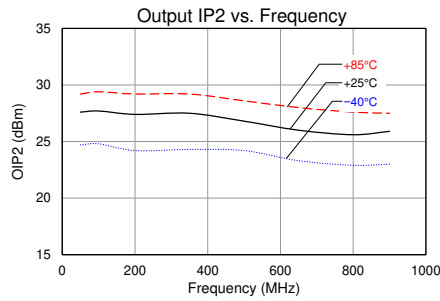
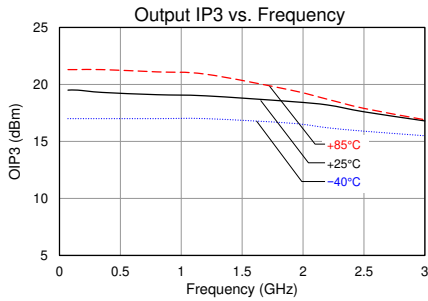
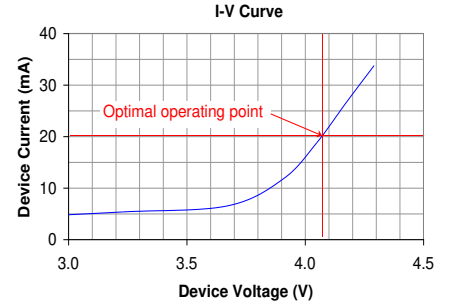
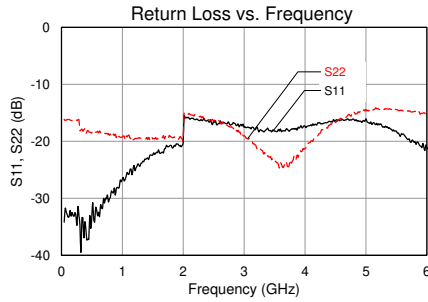
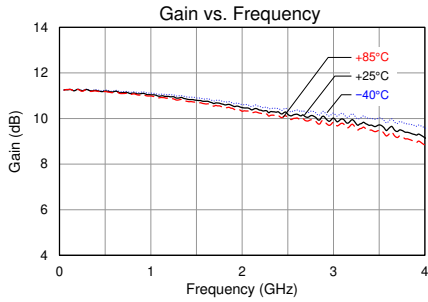

Performance Plots – AG201-63G (Supply Voltage +6V)

Test conditions unless otherwise noted: Supply Voltage = +6V, $I_{CC} = 20\text{ mA}$, $R_{BIAS} = 100\ \Omega$, Temp.=+25 °C

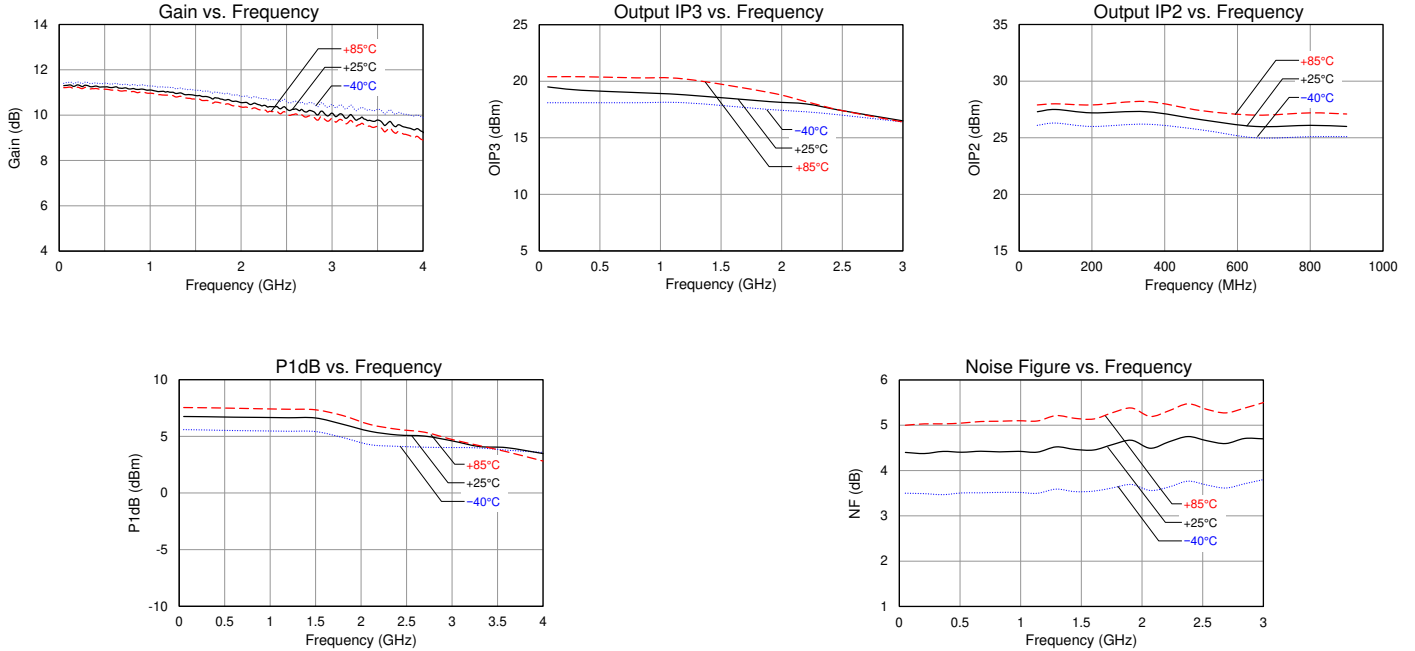

Performance Plots – AG201-63G (Supply Voltage +8V)

Test conditions unless otherwise noted: Supply Voltage = +8V, $I_{CC} = 20\text{ mA}$, $R_{BIAS} = 200\ \Omega$, Temp.=+25 °C

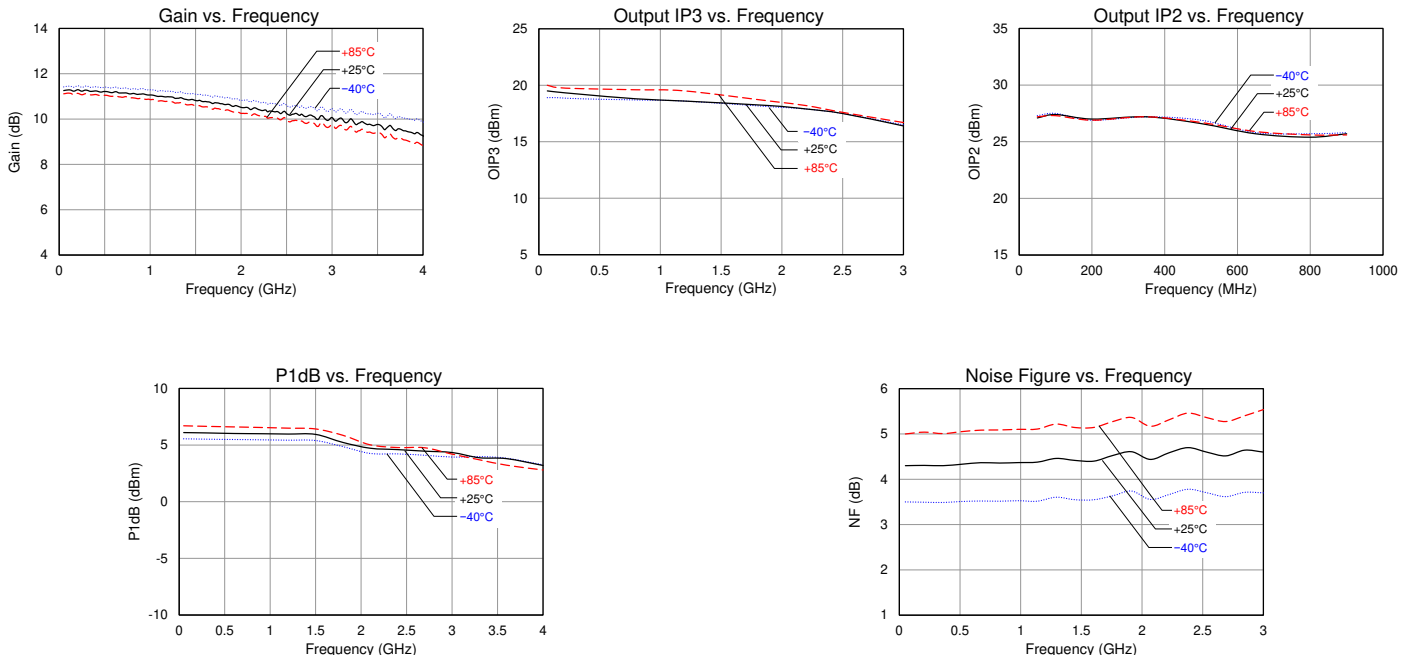

Pad Configuration and Description

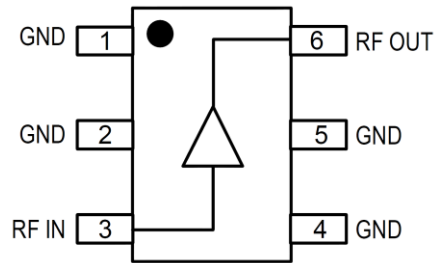

Top View

Pad No.	Label	Description
1, 2, 4, 5	GND	RF/DC ground. Use recommended via pattern to minimize inductance and thermal resistance. See PCB Mounting Pattern for suggested footprint.
3	RF IN	RF input. External DC Block required.
6	RF OUT	RF output and V_{DEVICE} . External DC Block and bias voltage required.

Package Marking and Dimensions

Marking: Part Designator – F
Lot Code – XX

SYMBOL	MIN	MAX
A	-	1.10 (.043)
A1	0	.10 (.004)
A2	.70 (.028)	1.00 (.039)
D	2.00 (.079)	BASIC
E	2.10 (.083)	BASIC
E1	1.25 (.039)	BASIC
L	.21 (.008)	.41 (.016)
L1	.42 (.017)	REF
L2	.15 (.006)	BASIC
θ	0°	8°
θ_1	4°	12°
b	.15 (.006)	.30 (.012)
c	.08 (.003)	.22 (.009)
e	.65 (.026)	BASIC
e1	1.30 (.051)	BASIC

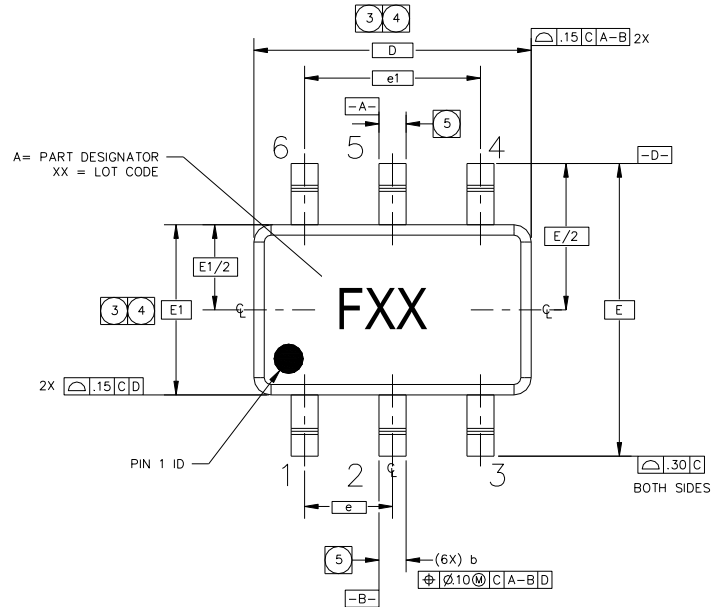

TOP VIEW

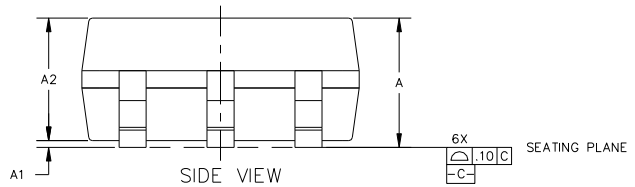
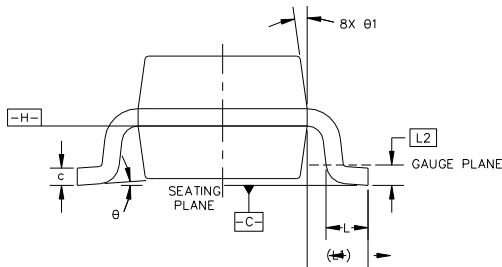

SIDE VIEW

NOTES:

- DIMENSIONS AND TOLERANCING PER ASME Y14.5M-1194. PACKAGE CONFORMS TO JEDEC MO-203, ISSUE B.
- DIMENSIONS ARE IN MILLIMETERS (INCHES).
- DIMENSION D DOES NOT INCLUDE MOLD FLASH, PROTRUSIONS OR GATE BURRS. MOLD FLASH, PROTRUSIONS OR GATE BURRS SHALL NOT EXCEED 0.15 mm PER END. DIMENSION E1 DOES NOT INCLUDE INTERLEAD FLASH OR PROTRUSION. INTERLEAD FLASH OR PROTRUSION SHALL NOT EXCEED 0.15 mm PER SIDE. D AND E1 DIMENSIONS ARE DETERMINED AT DATUM H.
- THE PACKAGE TOP MAY BE SMALLER THAN THE PACKAGE BOTTOM. DIMENSIONS D AND E1 ARE DETERMINED AT THE OUTERMOST EXTREMES OF THE PLASTIC BODY EXCLUSIVE OF MOLD FLASH, TIE BAR BURRS, GATE BURRS AND INTERLEAD FLASH, BUT INCLUDING ANY MISMATCH BETWEEN THE TOP AND THE BOTTOM OF THE PLASTIC BODY. D AND E1 DIMENSIONS ARE DETERMINED AT DATUM H.

- 5 DATUM A & B TO BE DETERMINED AT DATUM H.
- 6 DIMENSION 'b' DOES NOT INCLUDE DAMBAR PROTRUSION. ALLOWABLE DAMBAR PROTRUSION SHALL BE 0.08 mm TOTAL IN EXCESS OF THE "b" DIMENSION AT MAXIMUM MATERIAL CONDITION. THE DAMBAR IS NOT LOCATED ON THE LOWER RADIUS OF THE FOOT. MINIMUM SPACE BETWEEN PROTRUSION AND AN ADJACENT LEAD SHALL NOT BE LESS THAN 0.07 mm.

Notes:

- All dimensions are in millimeters. Angles are in degrees.
- The terminal #1 identifier and terminal numbering conform to JESD 95-1 SPP-012.
- Contact plating: Matte-Tin (Thickness: 7.6 to 20 μ m)

PCB Mounting Pattern

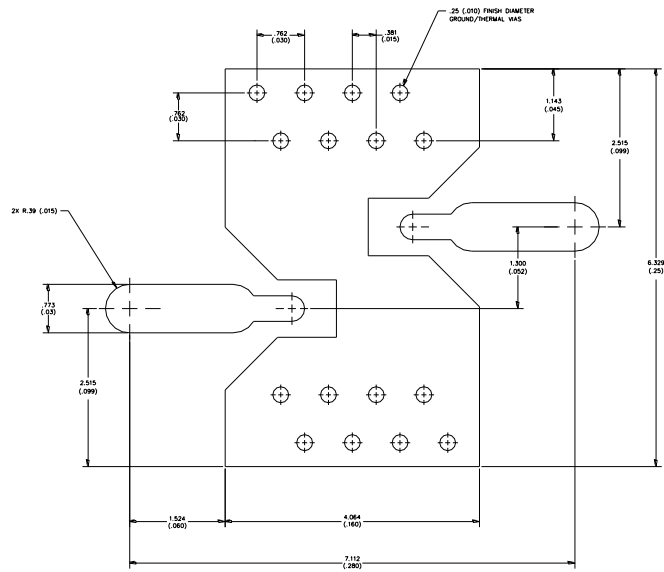

Notes:

1. All dimensions are in millimeters. Angles are in degrees.
2. Use 1 oz. copper minimum for top and bottom layer metal. And Make copper metal area as much as possible in inner and outer layers near the part to obtain optimal thermal performance
3. Via holes are required under the backside paddle of this device for proper RF/DC grounding and thermal dissipation. We recommend a 0.35mm (#80/.0135") diameter bit for drilling via holes and a final plated thru diameter of 0.25 mm (0.01").
4. No solder mask on the backside of the PCB in the region where the board contacts the heatsink
5. Mounting screws can be added near the part to fasten the board to a heatsink. To ensure the ground and thermal via holes contact the heatsink

Handling Precautions

Parameter	Rating	Standard
ESD – Human Body Model (HBM)	Class 1C	ESDA / JEDEC JS-001-2012
ESD – Charged Device Model (CDM)	Class C3	JEDEC JESD22-C101F
MSL – Moisture Sensitivity Level	Level 3	IPC/JEDEC J-STD-020



Caution!
ESD-Sensitive Device

Solderability

Compatible with both lead-free (260°C max. reflow temp.) and tin/lead (245°C max. reflow temp.) soldering processes. Solder profiles available upon request.

Contact plating: Matte Tin (*Thickness: 7.6 to 20 μm*)

RoHS Compliance

This part is compliant with 2011/65/EU RoHS directive (Restrictions on the Use of Certain Hazardous Substances in Electrical and Electronic Equipment) as amended by Directive 2015/863/EU.

This product also has the following attributes:

- Lead Free
- Halogen Free (Chlorine, Bromine)
- Antimony Free
- TBBP-A (C₁₅H₁₂Br₄O₂) Free
- PFOS Free
- SVHC Free



Contact Information

For the latest specifications, additional product information, worldwide sales and distribution locations:

Web: www.qorvo.com

Tel: 1-844-890-8163

Email: customer.support@qorvo.com

For technical questions and application information:

Email: appsupport@qorvo.com

Important Notice

The information contained herein is believed to be reliable; however, Qorvo makes no warranties regarding the information contained herein and assumes no responsibility or liability whatsoever for the use of the information contained herein. All information contained herein is subject to change without notice. Customers should obtain and verify the latest relevant information before placing orders for Qorvo products. The information contained herein or any use of such information does not grant, explicitly or implicitly, to any party any patent rights, licenses, or any other intellectual property rights, whether with regard to such information itself or anything described by such information. **THIS INFORMATION DOES NOT CONSTITUTE A WARRANTY WITH RESPECT TO THE PRODUCTS DESCRIBED HEREIN, AND QORVO HEREBY DISCLAIMS ANY AND ALL WARRANTIES WITH RESPECT TO SUCH PRODUCTS WHETHER EXPRESS OR IMPLIED BY LAW, COURSE OF DEALING, COURSE OF PERFORMANCE, USAGE OF TRADE OR OTHERWISE, INCLUDING THE IMPLIED WARRANTIES OF MERCHANTABILITY AND FITNESS FOR A PARTICULAR PURPOSE.**

Without limiting the generality of the foregoing, Qorvo products are not warranted or authorized for use as critical components in medical, life-saving, or life-sustaining applications, or other applications where a failure would reasonably be expected to cause severe personal injury or death.

Copyright 2018 © Qorvo, Inc. | Qorvo is a registered trademark of Qorvo, Inc.