

# AU OPTRONICS CORPORATION

## Product Specification

### 17.0" SXGA Color TFT-LCD Module

**Model Name: M170EG01 V.8**

Approved by	Prepared by
<i>CC Chiu</i>	<i>Flossie Chuang.</i>

*DDBU Marketing Division / AU Optronics*

Customer	Checked & Approved by

## Product Specification

**17.0" SXGA Color TFT-LCD Module**

**Model Name: M170EG01**

**V.8**

**(◆) Preliminary Specifications**

**( ) Final Specifications**

**Note: This Specification is subject to change without notice.**

## Contents

<b>1.0 Handling Precautions.....</b>	<b>5</b>
<b>2.0 General Description .....</b>	<b>6</b>
2.1 Display Characteristics.....	6
2.2 Optical Characteristics.....	7
<b>3.0 Functional Block Diagram .....</b>	<b>10</b>
<b>4.0 Absolute Maximum Ratings.....</b>	<b>11</b>
4.1 TFT LCD Module .....	11
4.2 Backlight Unit.....	11
4.3 Absolute Ratings of Environment.....	11
<b>5.0 Electrical characteristics .....</b>	<b>12</b>
5.1 TFT LCD Module .....	12
5.1.1 Power Specification.....	12
5.1.2 Signal Electrical Characteristics.....	13
5.2 Backlight Unit.....	14
<b>6.0 Signal Characteristic.....</b>	<b>15</b>
6.1 Pixel Format Image .....	15
6.2 The input data format.....	15
6.3 Signal Description.....	16
6.4 Interface Timing.....	17
6.4.1 Timing Characteristics.....	17
6.4.2 Timing diagram .....	18
6.5 Power ON/OFF Sequence .....	19
<b>7.0 Connector &amp; Pin Assignment.....</b>	<b>20</b>
7.1 TFT LCD Module .....	20
7.2 Backlight Unit.....	21
7.3 Signal for Lamp connector.....	21
<b>8.0 Reliability .....</b>	<b>22</b>
<b>9.0 Safety .....</b>	<b>23</b>
9.1 Sharp Edge Requirements.....	23
9.2 Materials .....	23
9.2.1 Toxicity.....	23
9.2.2 Flammability.....	23
9.3 Capacitors.....	23
<b>10.0 Other requirement .....</b>	<b>23</b>
10.1 National Test Lab Requirement.....	23
10.2 Label.....	23
<b>11.0 Mechanical Characteristics.....</b>	<b>24</b>

## Record of Revision

Version and Date	Page	Old description	New Description	Remark
0.1 2005/02/28	All	First Edition for Customer		

## 1.0 Handling Precautions

- 1) Since front polarizer is easily damaged, pay attention not to scratch it.
- 2) Be sure to turn off power supply when inserting or disconnecting from input connector.
- 3) Wipe off water drop immediately. Long contact with water may cause discoloration or spots.
- 4) When the panel surface is soiled, wipe it with absorbent cotton or other soft cloth.
- 5) Since the panel is made of glass, it may break or crack if dropped or bumped on hard surface.
- 6) Since CMOS LSI is used in this module, take care of static electricity and insure human earth when handling.
- 7) Do not open nor modify the Module Assembly.
- 8) Do not press or pat the panel surface by fingers, hand or tooling.
- 9) Do not press the reflector sheet at the back of the module to any directions.
- 10) In case if a module has to be put back into the packing container slot after once it was taken out from the container, do not press the center of the CCFL reflector edge. Instead, press at the far ends of the CCFL reflector edge softly. Otherwise the TFT module may be damaged.
- 11) At the insertion or removal of the Signal Interface Connector, be sure not to rotate nor tilt the Interface Connector of the TFT module.
- 12) After installation of the TFT module into an enclosure (Desktop monitor Bezel, for example), do not twist nor bend the TFT Module even momentary. At designing the enclosure, it should be taken into consideration that no bending/twisting forces are applied to the TFT module from outside. Otherwise the TFT module may be damaged.

## 2.0 General Description

This specification applies to the 17.0 inch Color TFT/LCD Module M170EG01 V8.

This module is designed for a display unit of personal computer.

The display supports the SXGA (1280(H) x 1024(V)) screen format and 16.2M colors (RGB 6-bits + FRC data).

All input signals are 2 Channel LVDS interface compatible.

This module does not contain an inverter card for backlight.

## 2.1 Display Characteristics

The following items are characteristics summary on the table under 25 condition:

ITEMS	Unit	SPECIFICATIONS			
Screen Diagonal	[mm]	432(17.0")			
Active Area	[mm]	337.920 (H) x 270.336(V)			
Pixels H x V		1280(x3) x 1024			
Pixel Pitch	[mm]	0.264 (per one triad) x 0.264			
Pixel Arrangement		R.G.B. Vertical Stripe			
Display Mode		Normally White			
White Luminance	[cd/m <sup>2</sup> ]	300 (Typ)			
Contrast Ratio		500 : 1 (Typ)			
Optical Rise Time/Fall Time	[msec]	8 (Typ) <b>(Note 1)</b>			
Color Saturation		72% NTSC			
Nominal Input Voltage VDD	[Volt]	+5.0 V			
Power Consumption (VDD line + CCFL line)	[Watt]	25.8 W(Typ) (PDD=6 W, PCFL=19.8 W @Lamp=7.5mA)			
Weight	[Grams]	1900 (Typ)			
Physical Size	[mm]		Min.	Typ.	Max.
		Horizatal(H)	358	358.5	359.0
		Vertical(V)	296	296.5	297
		Depth(D)	16.5	17.0	17.5
Electrical Interface		Dual Channel LVDS			
Support Color		16.2M colors (RGB 6-bit + FRC data)			
Temperature Range					
	Operating	[°C]	0 to +50		
Storage (Shipping)	[°C]	-20 to +60			
Surface Treatment		Hard-coating (3H), Anti-Glare treatment			

**Note 1:** System should be warmed up at least one hour

## 2.2 Optical Characteristics

The optical characteristics are measured under stable conditions at 25 (Room Temperature):

Item	Unit	Conditions	Min.	Typ.	Max.	Note
Viewing Angle	[degree]	Horizontal (Right) CR = 10 (Left)	60 60	70 70		-
		Vertical (Up) CR = 10 (Down)	60 50	70 60		-
		Horizontal (Right) CR = 5 (Left)	70 70	80 80		
		Vertical (Up) CR = 5 (Down)	70 70	80 80		
Contrast ratio		Normal Direction	300	500		-
Response Time	[msec]	Rising Time	-	6	9	<b>Note 1</b>
		Falling Time	-	2	4	
		Rising + Falling	-	8	13	
Color / Chromaticity Coordinates (CIE)		Red x	0.61	0.64	0.67	
		Red y	0.31	0.34	0.37	
		Green x	0.26	0.29	0.32	
		Green y	0.58	0.61	0.64	
		Blue x	0.11	0.14	0.17	
		Blue y	0.04	0.07	0.10	
Color Coordinates (CIE) White		White x	0.28	0.31	0.34	
		White y	0.30	0.33	0.36	
White Luminance @ CCFL 7.5mA (center)	[cd/m <sup>2</sup> ]		240	300		-
Luminance Uniformity	[%]		75	80		<b>Note 2</b>
Crosstalk (in 75Hz)	[%]				1.5	<b>Note 3</b>
Flicker	dB				-20	<b>Note 4</b>

**Equipment** Pattern Generator, Power Supply, Digital Voltmeter, Luminance meter  
(PR 880, BM-5A / BM7, CS-1000, CA210, SR\_3, EZ Contrast\*, Optiscope& Westar TRD-100)

Aperture 1 ° with 100cm VD or 2 ° with 50cm viewing distance

Test Point Center (VESA point 9)

Environment < 1 lux

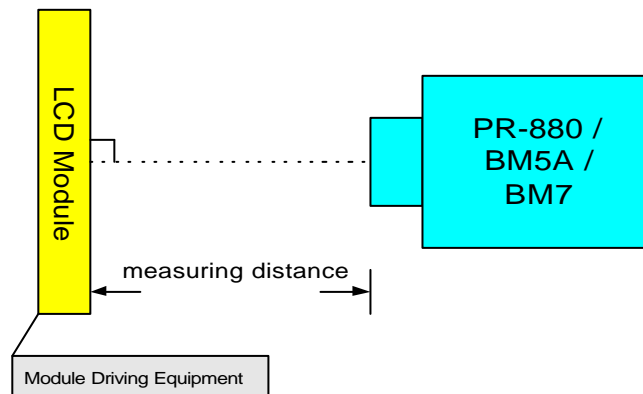

\* EZ Contrast is different measurement tool with very close viewing distance.

**Note 1: Definition of Response time**

The output signals of photodetector are measured when the input signals are changed from 'Full Black' to 'Full White' (rising time), and from 'Full White' to 'Full Black' (falling time), respectively. The response time is interval between the 10% and 90% of amplitudes.

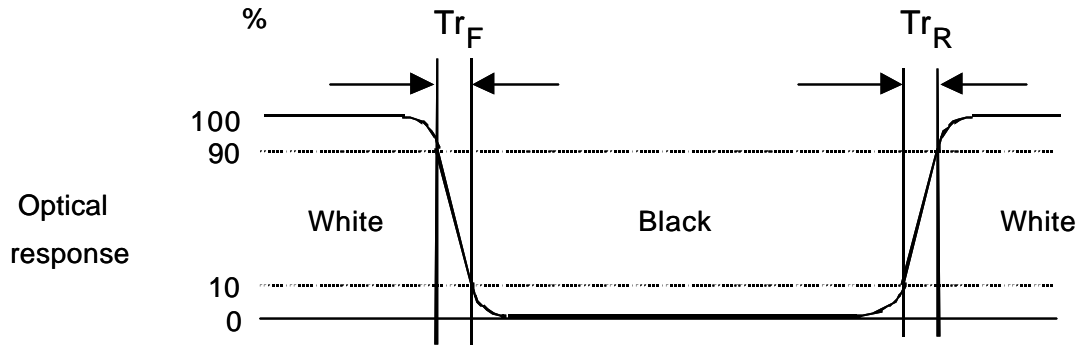

**Note 2: Brightness uniformity of these 9 points is defined as below**

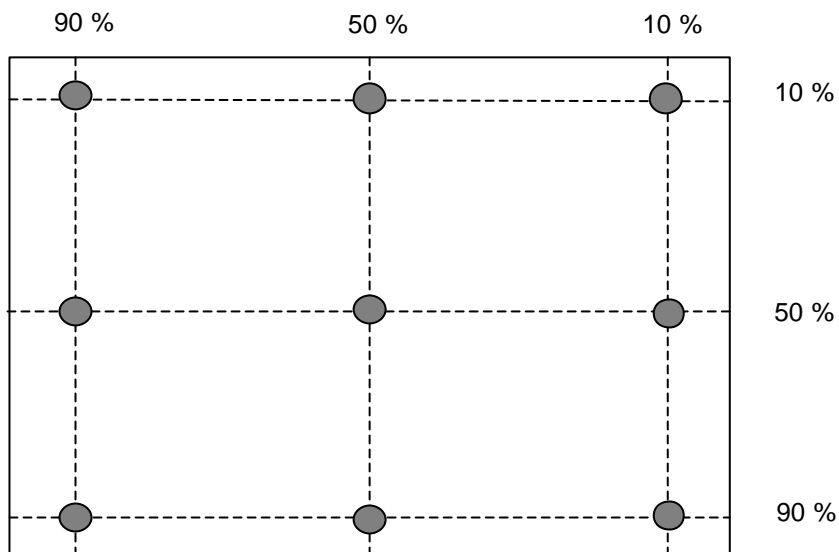

$$\text{Uniformity} = \frac{\text{Minimum Luminance in 9 points (1-9)}}{\text{Maximum Luminance in 9 Points (1-9)}}$$



**Note 3:** Crosstalk is defined as below :

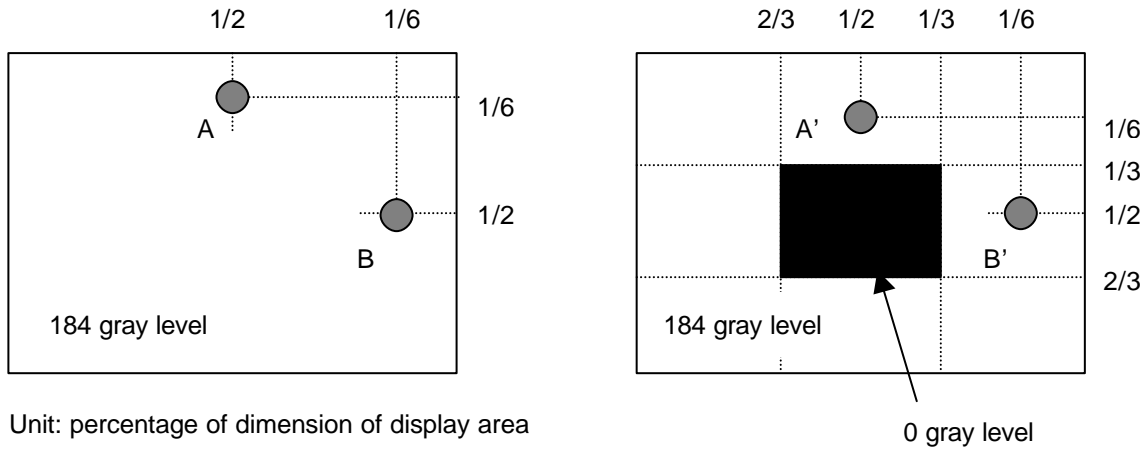

Unit: percentage of dimension of display area

$|L_A - L_{A'}| / L_A \times 100\% = 1.5\% \text{ max.}$ ,  $L_A$  and  $L_B$  are brightness at location A and B

$|L_B - L_{B'}| / L_B \times 100\% = 1.5\% \text{ max.}$ ,  $L_{A'}$  and  $L_{B'}$  are brightness at location A' and B'

**Note 4:** Test Patern: Subchecker Pattern

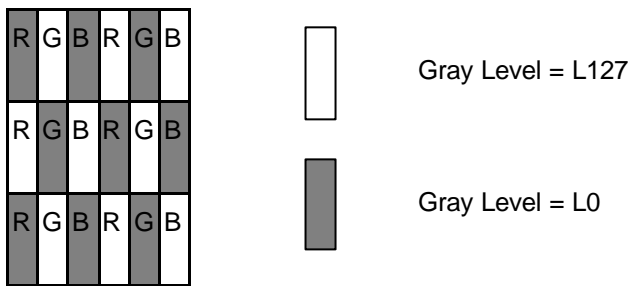

Method: Record dBV & DC value with (WESTAR)TRD-100

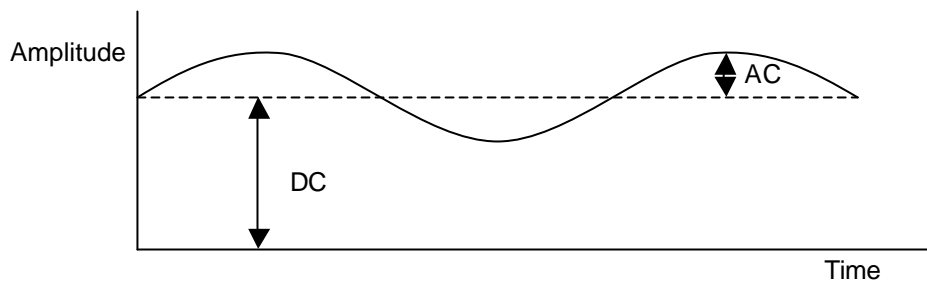

$$\text{Flicker (dB)} = 20 \log \frac{\text{AC Level(at 30 Hz)}}{\text{DC Level}}$$

### 3.0 Functional Block Diagram

The following diagram shows the functional block of the 19.0 inches wide Color TFT/LCD Module:

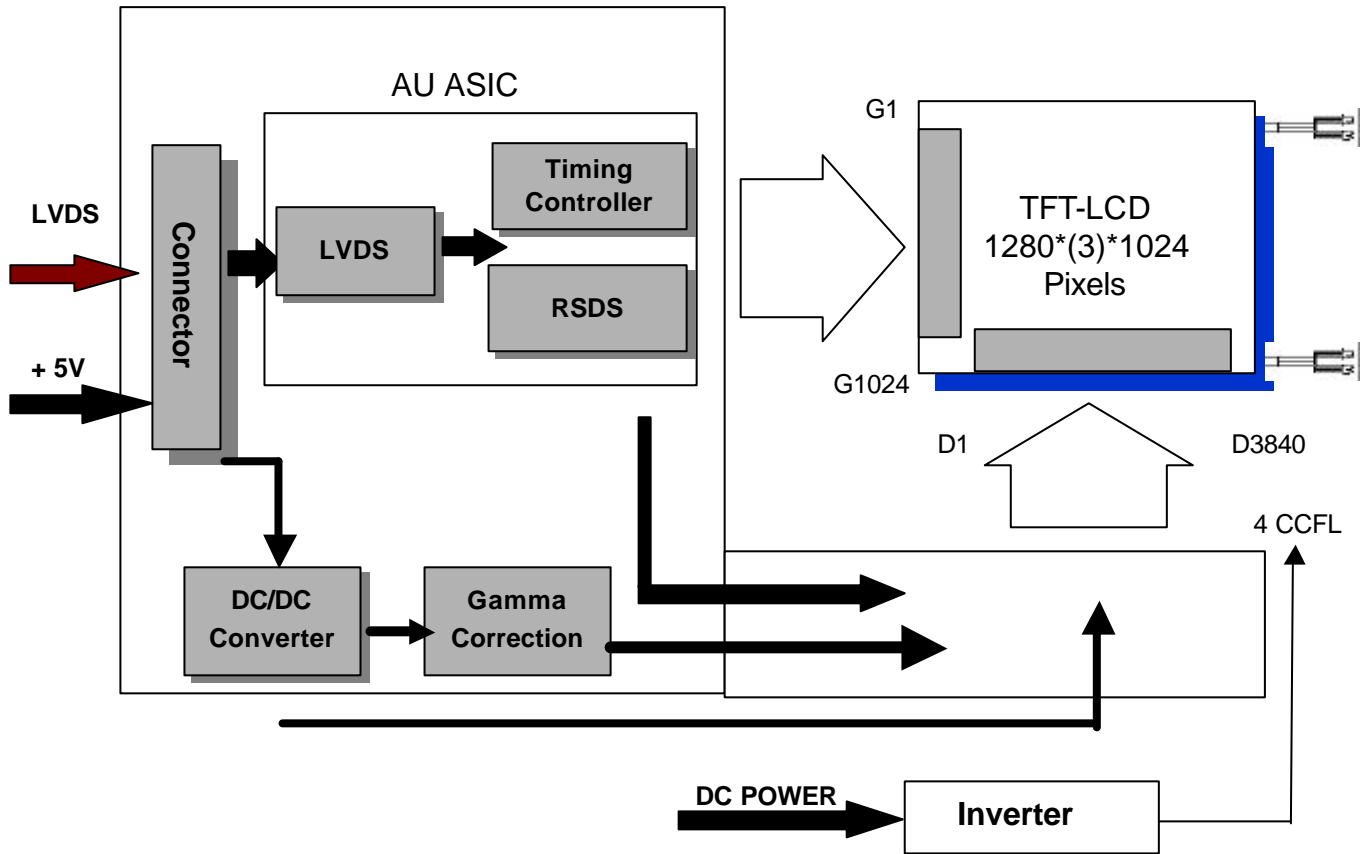

AL2307-A0G1D-P / FI-XB30SSRL-HF16

JST-BHSR-02VS-1 ( 2pin x2 )

Mating Type: JAE FI-X30HL

SM02B-BHSS-1-TB

## 4.0 Absolute Maximum Ratings

Absolute maximum ratings of the module is as following:

### 4.1 TFT LCD Module

Item	Symbol	Min	Max	Unit	Conditions
Logic/LCD Drive Voltage	VIN	-0.3	+6	[Volt]	<b>Note 1,2</b>

### 4.2 Backlight Unit

Item	Symbol	Min	Max	Unit	Conditions
CCFL Current	ICFL	-	8.5	[mA] rms	<b>Note 1,2</b>

### 4.3 Absolute Ratings of Environment

Item	Symbol	Min	Max	Unit	Conditions
Operating Temperature	TOP	0	+50	[°C]	<b>Note 3</b>
Operating Humidity	HOP	5	90	[%RH]	<b>Note 3</b>
Storage Temperature	TST	-20	+60	[°C]	<b>Note 3</b>
Storage Humidity	HST	5	90	[%RH]	<b>Note 3</b>

Please refer the graph below for corresponding of Min/Max values of temperature and humidity.

**Note 1:** With in Ta (25 )

**Note 2:** Permanent damage to the device may occur if exceed maximum values

**Note 3:** For quality performance, please refer to AUO IIS(Incoming Inspection Standard).

#### Relative Humidity %

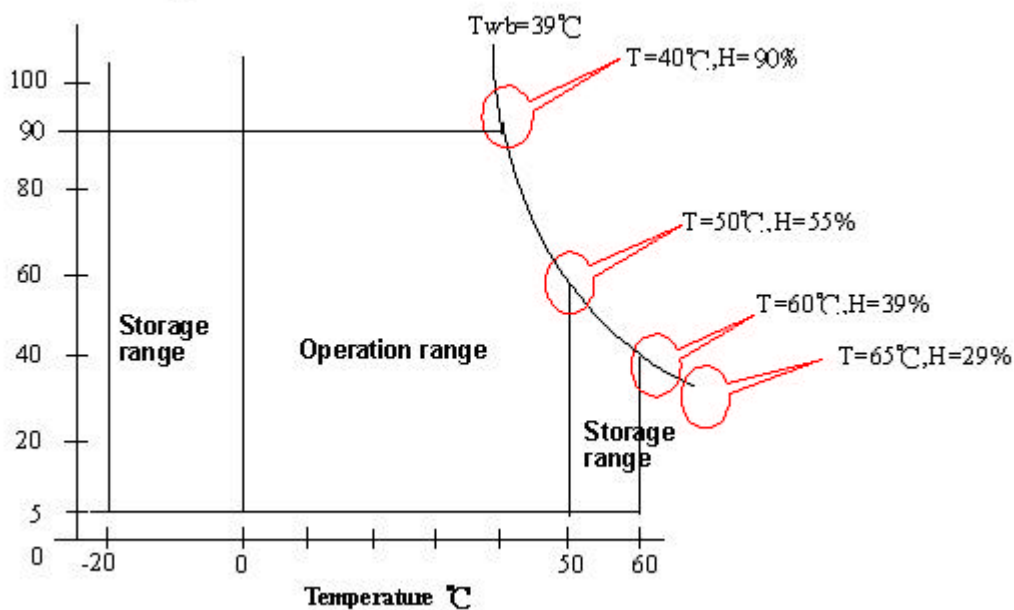

## 5.0 Electrical characteristics

### 5.1 TFT LCD Module

#### 5.1.1 Power Specification

Input power specifications are as follows;

Symbol	Parameter	Min	Typ	Max	Units	Condition
VDD	Logic/LCD Drive Voltage	4.5	5	5.5	[Volt]	± 10%
IDD	VDD current	-	1200	1560	[mA]	Vin=5V , All Black Pattern, at 75Hz
Irush	LCD Inrush Current	-	-	2.5	[A]	<b>Note</b>
PDD	VDD Power		6	7.8	[Watt]	Vin=5V , All Black Pattern, at 75Hz
VDDrp	Allowable Logic/LCD Drive Ripple Voltage			100	[mV] p-p	Vin=5V , All Black Pattern, at 75Hz

**Note:** Measurement conditions:

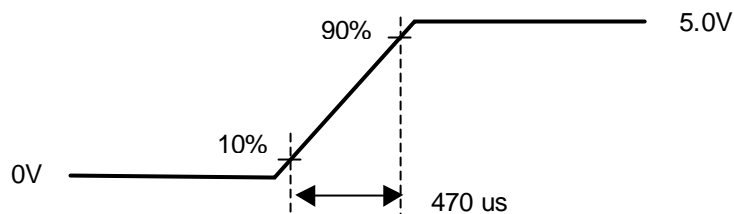
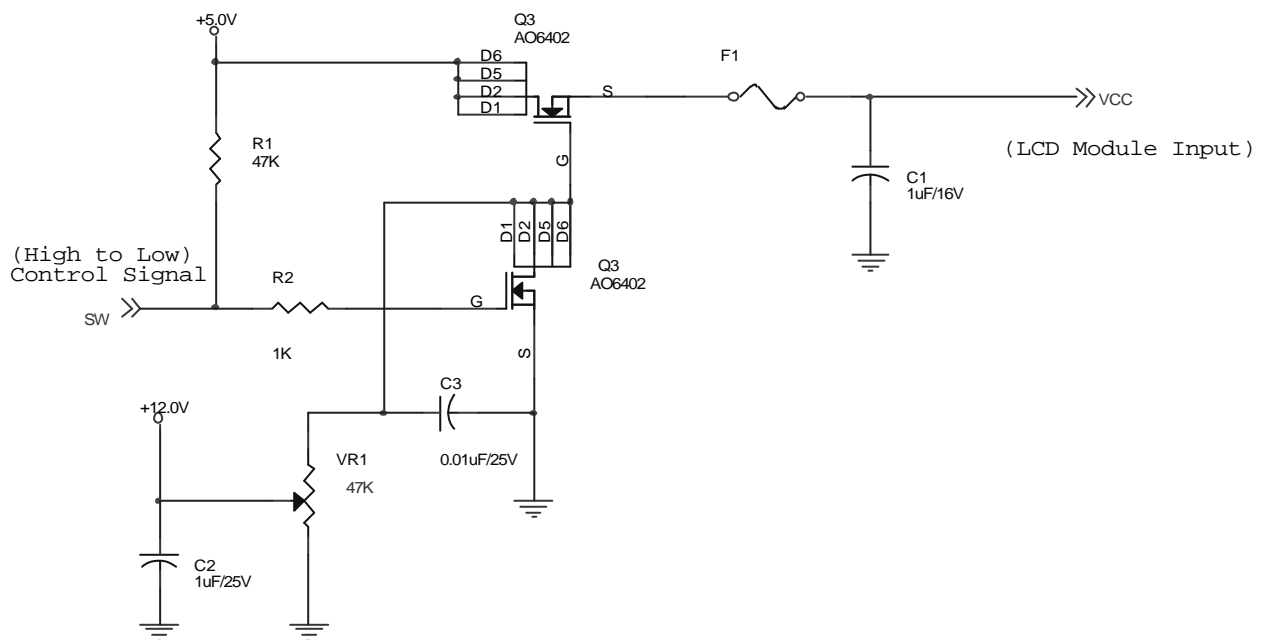

Vin rising time

### 5.1.2 Signal Electrical Characteristics

Input signals shall be low or Hi-Z state when  $V_{in}$  is off

It is recommended to refer the specifications of SN75LVDS82DGG (Texas Instruments) in detail.

Each signal characteristics are as follows;

Symbol	Parameter	Min	Typ	Max	Units	Condition
VTH	Differential Input High Threshold	-	-	100	[mV]	$V_{ICM} = 1.2V$ <b>Note</b>
VTL	Differential Input Low Threshold	-100	-	-	[mV]	$V_{ICM} = 1.2V$ <b>Note</b>
VID	Input Differential Voltage	100	400	600	[mV]	<b>Note</b>
VICM	Differential Input Common Mode Voltage	1.1	-	1.45	[V]	$V_{TH}/V_{TL} = \pm 100mV$ <b>Note</b>

**Note:** LVDS Signal Waveform

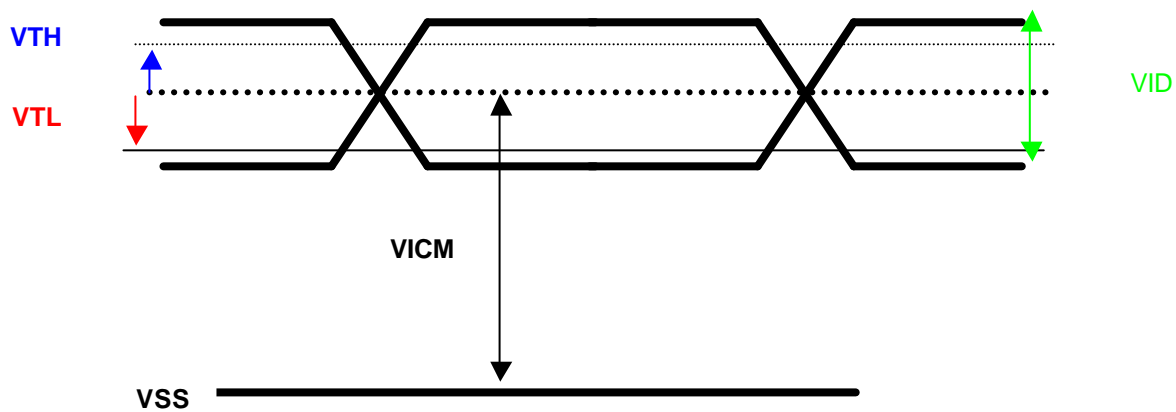

## 5.2 Backlight Unit

Parameter guideline for CCFL Inverter

Symbol	Parameter	Min.	Typ.	Max.	Unit	Condition
ISCFL	CCFL standard current	7.0	7.5	8.0	[mA] rms	(Ta=25°C) <b>Note 1</b>
IRCFL	CCFL operation range	3.0	7.5	8.0	[mA] rms	(Ta=25°C)
FCFL	CCFL Frequency	40	60	80	[KHz]	(Ta=25°C) <b>Note 2</b>
ViCFL (0°C)	CCFL Ignition Voltage (End of the lamp wire connector)	1500	-	-	[Volt] rms	(Ta=0°C)
ViCF (25°C)	CCFL Ignition Voltage (End of the lamp wire connector)	1150	-	-	[Volt] rms	(Ta=25°C)
VCFL	CCFL Operation Voltage	-	660 @7.5mA	700 @3.0mA	[Volt] rms	(Ta=25°C) <b>Note 1</b>
PCFL	CCFL Power consumption (for reference)	-	19.8	21.8	[Watt]	(Ta=25°C) <b>Note 3</b>
LTCFL	CCFL life Time	30,000	50,000	-	[Hour]	(Ta=25°C) <b>Note 4</b>

**Note 1:** CCFL standard current is measured at 25 ±2 .

**Note 2:** CCFL Frequency should be carefully determined to avoid interference between inverter and TFT LCD

**Note 3:** The variance of CCFL power consumption is ± 10%. Calculator value for reference (ICFL×VCFL×4=PCFL).

**Note 4:** CCFL life time is determined as the time at which brightness of lamp is 50%. The typical life time of CCFL is on the condition at 7.5 mA lamp current.

## 6.0 Signal Characteristic

### 6.1 Pixel Format Image

Following figure shows the relationship of the input signals and LCD pixel format.

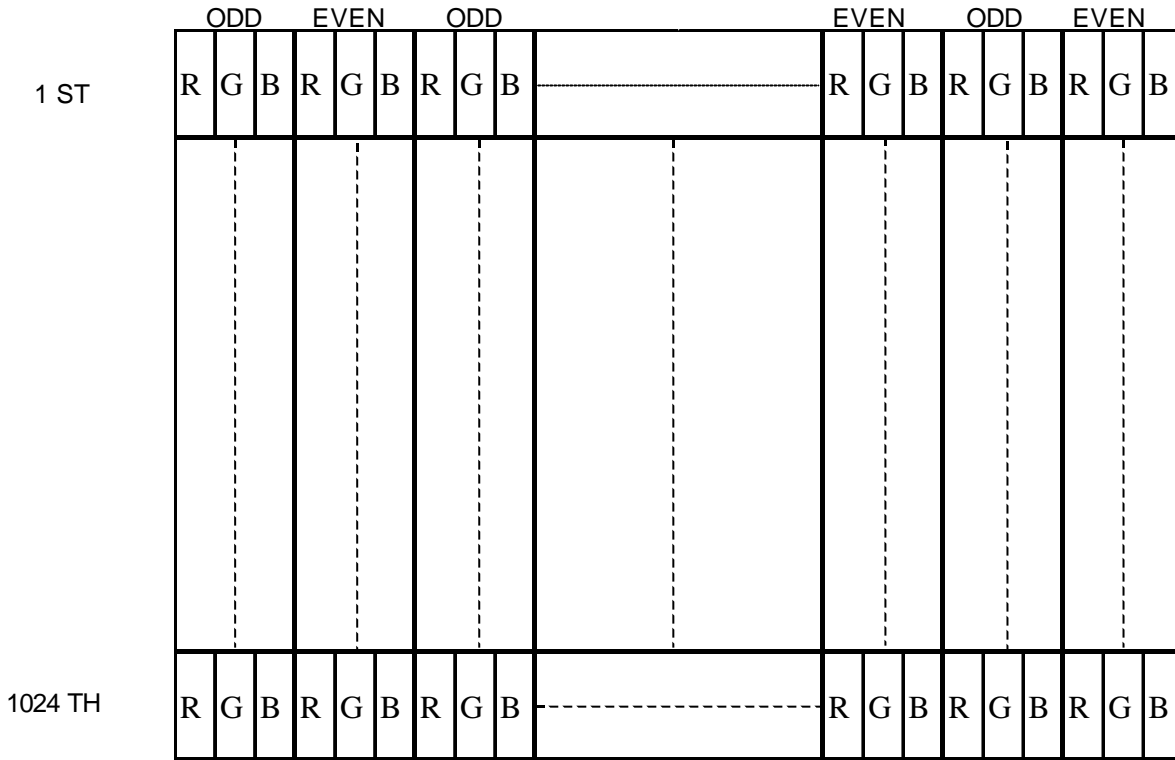

### 6.2 The input data format

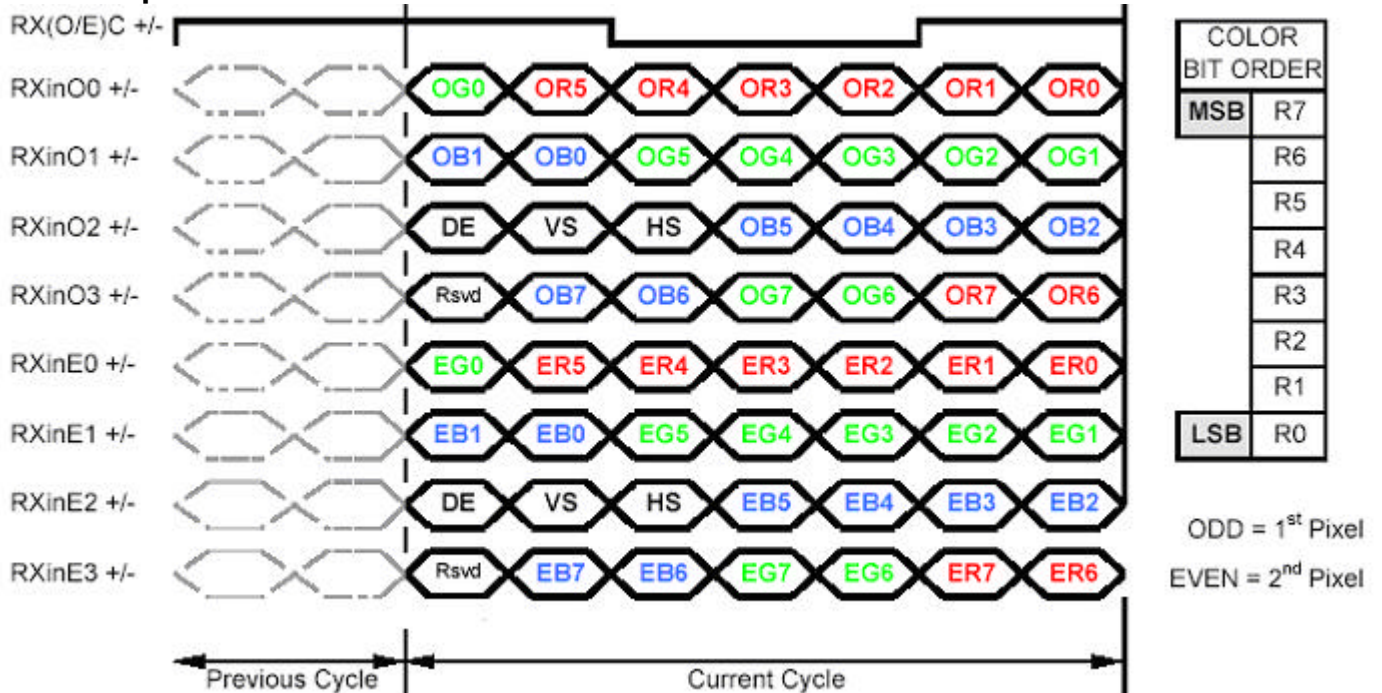

**Note1:** Normally, DE, VS, HS on EVEN channel are not used.

**Note2:** Please follow PSWG.

**Note3:** 8-bit in

### 6.3 Signal Description

The module using a pair of LVDS receiver SN75LVDS82(Texas Instruments) or compatible. LVDS is a differential signal technology for LCD interface and high speed data transfer device. Transmitter shall be SN75LVDS83(negative edge sampling) or compatible. The first LVDS port(RxOxxx) transmits odd pixels while the second LVDS port(RxExxx) transmits even pixels.

PIN #	SIGNAL NAME	DESCRIPTION
1	RxOIN0-	Negative LVDS differential data input (Odd data)
2	RxOIN0+	Positive LVDS differential data input (Odd data)
3	RxOIN1-	Negative LVDS differential data input (Odd data)
4	RxOIN1+	Positive LVDS differential data input (Odd data)
5	RxOIN2-	Negative LVDS differential data input (Odd data, H-Sync,V-Sync,DSPTMG)
6	RxOIN2+	Positive LVDS differential data input (Odd data, H-Sync,V-Sync,DSPTMG)
7	VSS	Power Ground
8	RxOCLKIN-	Negative LVDS differential clock input (Odd clock)
9	RxOCLKIN+	Positive LVDS differential clock input (Odd clock)
10	RxOIN3-	Negative LVDS differential data input (Odd data)
11	RxOIN3+	Positive LVDS differential data input (Odd data)
12	RxEIN0-	Negative LVDS differential data input (Even data)
13	RxEIN0+	Positive LVDS differential data input (Even data)
14	VSS	Power Ground
15	RxEIN1-	Positive LVDS differential data input (Even data)
16	RxEIN1+	Negative LVDS differential data input (Even data)
17	VSS	Power Ground
18	RxEIN2-	Negative LVDS differential data input (Even data)
19	RxEIN2+	Positive LVDS differential data input (Even data)
20	RxECLKIN-	Negative LVDS differential clock input (Even clock)
21	RxECLKIN+	Positive LVDS differential clock input (Even clock)
22	RxEIN3-	Negative LVDS differential data input (Even data)
23	RxEIN3+	Positive LVDS differential data input (Even data)
24	VSS	Power Ground
25	VSS	Power Ground
26	NC	No Connection ( for AUO test)
27	VSS	Power Ground
28	VCC	+5.0V Power Supply
29	VCC	+5.0V Power Supply
30	VCC	+5.0V Power Supply



**Note1:** Start from left side

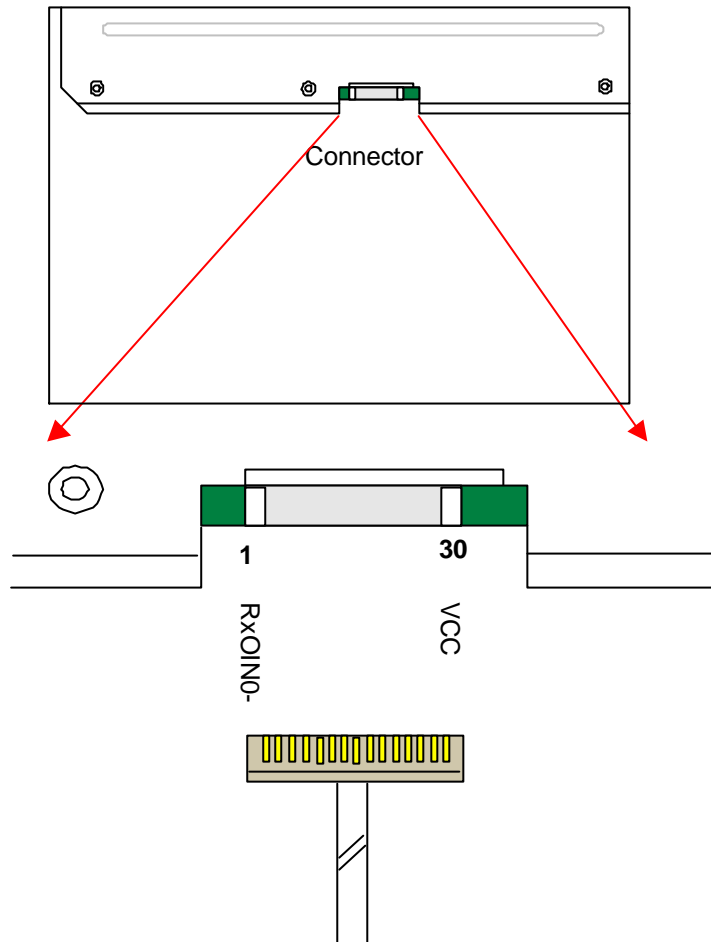

**Note2:** Input signals of odd and even clock shall be the same timing.

**Note3:** Please follow PSWG.

## 6.4 Interface Timing

### 6.4.1 Timing Characteristics

Basically, interface timings described here is not actual input timing of LCD module but output timing of SN75LVDS82DGG (Texas Instruments) or equivalent.

Item	Symbol	Min	Typ	Max	Unit	
Data CLK	Tclk	40	54	70	MHz	
H-section	Period	Th	685	844	1024	Tclk
	Display Area	Tdisp(h)	640	640	640	Tclk
V-section	Period	Tv	1036	1066	2048	Th
	Display Area	Tdisp(v)	1024	1024	1024	Th
Frame Rate	F	49	60	76	Hz	

**Note :** DE mode only

### 6.4.2 Timing diagram

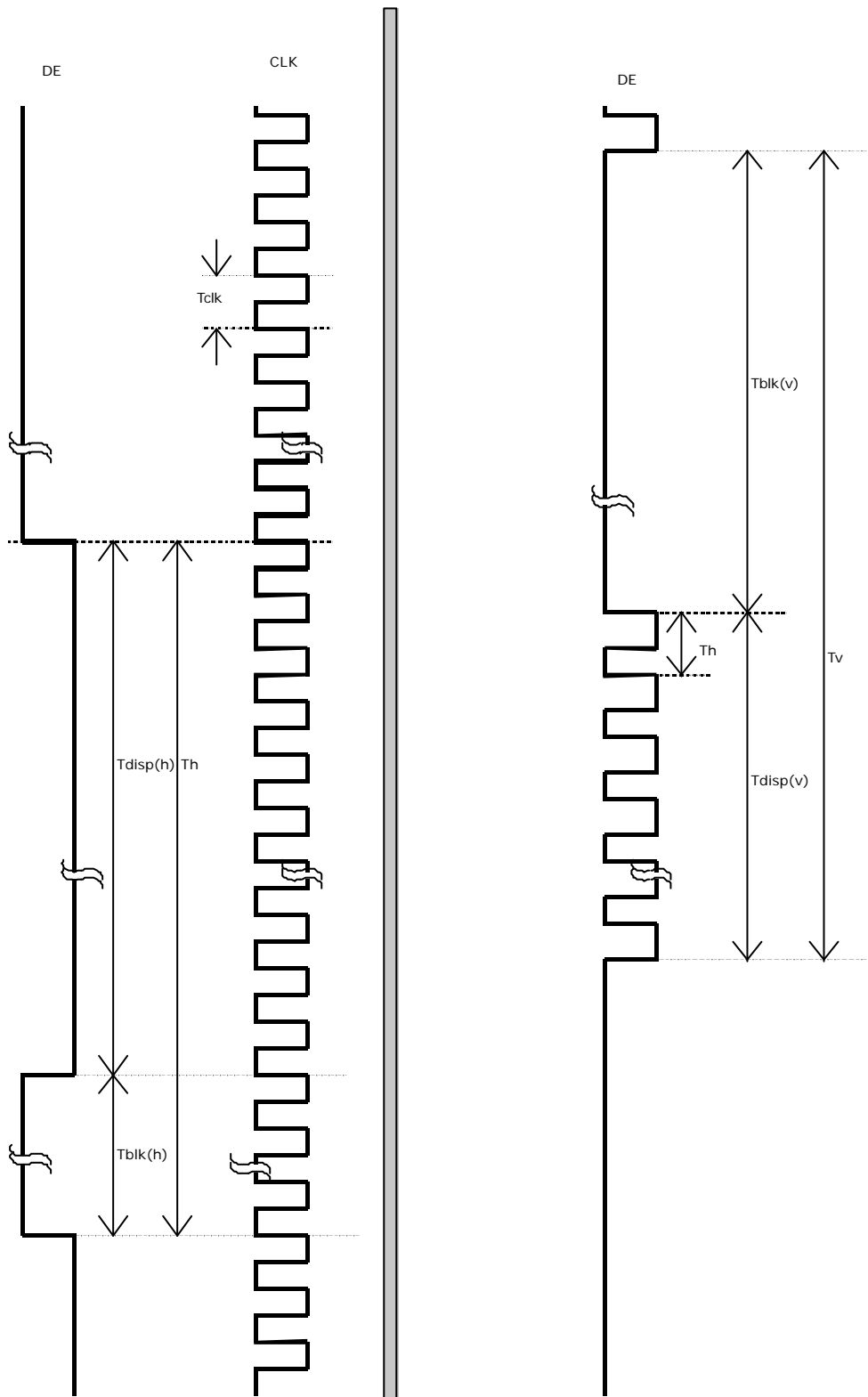

## 6.5 Power ON/OFF Sequence

Vin power and lamp on/off sequence is as follows. Interface signals are also shown in the chart. Signals from any system shall be Hi-Z state or low level when Vin is off.

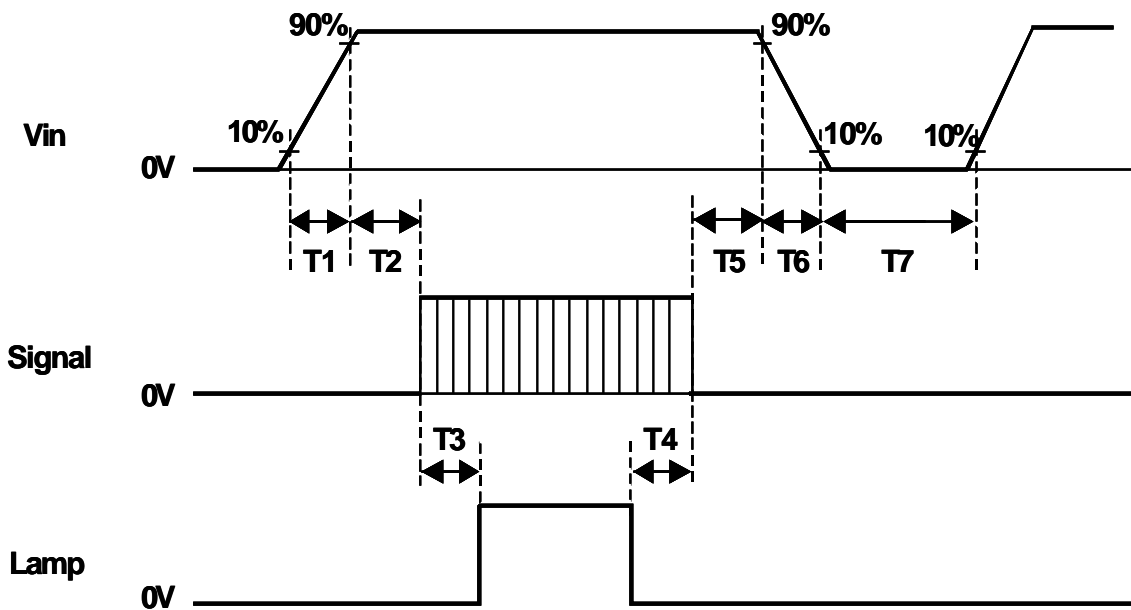

Symbol	Values			Unit
	Min.	Typ.	Max.	
T1	0.5	-	10	ms
T2	0	-	10	ms
T3	200	-	-	ms
T4	100	-	-	ms
T5	0	16	50	ms
T6	-	-	10	ms
T7	1000	-	-	ms

**Note:** The values of the table are follow PSWG.

## 7.0 Connector & Pin Assignment

Physical interface is described as for the connector on module.

These connectors are capable of accommodating the following signals and will be following components.

### 7.1 TFT LCD Module

<b>Connector Name / Designation</b>	Interface Connector / Interface card
<b>Manufacturer</b>	P2 / JAE or compatible
<b>Type Part Number</b>	AL2307-A0G1D-P / FI-XB30SSRL-HF16
<b>Mating Housing Part Number</b>	JAE FI-X30HL

Pin#	Signal Name	Pin#	Signal Name
1	RxOIN0-	2	RxOIN0+
3	RxOIN1-	4	RxOIN1+
5	RxOIN2-	6	RxOIN2+
7	VSS	8	RxOCLKIN-
9	RxOCLKIN+	10	RxOIN3-
11	RxOIN3+	12	RxEIN0-
13	RxEIN0+	14	VSS
15	RxEIN1-	16	RxEIN1+
17	VSS	18	RxEIN2-
19	RxEIN2+	20	RxECLKIN-
21	RxECLKIN+	22	RxEIN3-
23	RxEIN3+	24	VSS
25	VSS	26	NC
27	VSS	28	VCC
29	VCC	30	VCC

### 7.2 Backlight Unit

<b>Connector Name / Designation</b>	Lamp Connector / Backlight lamp
<b>Manufacturer</b>	JST
<b>Type Part Number</b>	BHSR-02VS-1
<b>Mating Type Part Number</b>	SM02B-BHSS-1-TB

### 7.3 Signal for Lamp connector

	Connector No.	Pin No.	Input	Color	Function
Upper	CN1	1	Hot1	Pink	High Voltage
		2	Cold1	White	Low Voltage
	CN2	1	Hot2	Blue	High Voltage
		2	Cold2	Black	Low Voltage
Lower	CN3	1	Hot1	Pink	High Voltage
		2	Cold1	White	Low Voltage
	CN4	1	Hot2	Blue	High Voltage
		2	Cold2	Black	Low Voltage

## 8.0 Reliability

### Reliability test condition

No	Test Item	Test Condition
1	Temperature Humidity Bias (THB)	50 , 80%, 300hours
2	High Temperature Operation (HTO)	50 , 300hours
3	Low Temperature Operation (LTO)	0 , 300hours
4	High Temperature Storage (HTS)	60 , 300hours
5	Low Temperature Storage (LTS)	-20 , 300hours
6	Thermal Shock Test (TST)	-20 /30min, 60 /30min, 100 cycles
7	On/Off Test	On/10sec, Off/10sec, 30,000 cycles
8	Shock Test (Non-Operating)	50G, 20ms, Half-sine wave ( $\pm X$ , $\pm Y$ , $\pm Z$ )
9	Vibration Test (Non-Operating)	1.5G(10~200Hz P- P), 30 Minutes each Axis (X, Y, Z)
10	ESD (ElectroStatic Discharge)	Contact Discharge: $\pm 8KV$ , 150pF(330O ) 1sec, 8 points, 25 times/ point Air Discharge: $\pm 15KV$ , 150pF(330O ) 1sec, 8 points, 25 times/ point
11	Altitude Test	Operation:10,000 ft Non-Operation:30,000 ft
12	Drop Test	The drop height is 60cm

## 9.0 Safety

### 9.1 Sharp Edge Requirements

There will be no sharp edges or comers on the display assembly that could cause injury.

### 9.2 Materials

#### 9.2.1 Toxicity

There will be no carcinogenic materials used anywhere in the display module. If toxic materials are used, they will be reviewed and approved by the responsible AUO Toxicologist.

#### 9.2.2 Flammability

All components including electrical components that do not meet the flammability grade UL94-V1 in the module will complete the flammability rating exception approval process.

The printed circuit board will be made from material rated 94-V1 or better. The actual UL flammability rating will be printed on the printed circuit board.

### 9.3 Capacitors

If any polarized capacitors are used in the display assembly, provisions will be made to keep them from being inserted backwards.

## 10.0 Other requirement

### 10.1 National Test Lab Requirement

The display module will satisfy all requirements for compliance to

**UL 1950, First Edition**  
**CSA C22.2 No.950-M89**  
**EEC 950**  
**EN 60 950**

U.S.A. Information Technology Equipment  
 Canada, Information Technology Equipment  
 International, Information Technology Equipment  
 International, Information Processing Equipment  
 (European Norm for IEC950)

### 10.2 Label

The label is on the panel as shown below:



# 11.0 Mechanical Characteristics

