

# WL2852K

## High Input Voltage, Low Quiescent Current LDO

[Http://www.sh-willsemi.com](http://www.sh-willsemi.com)

### Descriptions

The WL2852K series is a high accuracy, high input voltage low quiescent current, high speed, and low dropout Linear regulator with high ripple rejection. The device is manufactured with Bi-CMOS process.

The WL2852K offers over-current limit and over temperature protection to ensure the device working in well conditions.

The WL2852K regulators are available in standard SOT-89-3L packages. Standard products are Pb-free and Halogen-free.

### Features

- Supply Voltage : 4.75V~40V
- Output Range : 1.8V~5.7V
- Output Accuracy : <+/-2%
- Output Current : 100mA (Up to 150mA Typ.)
- PSRR : 60dB @ 100Hz
- Dropout Voltage : 800mV @ I<sub>OUT</sub>=100mA
- Quiescent Current : 10μA@V<sub>IN</sub>=7V(Typ.)
- Recommend Capacitor : 10uF  
( Locate Cin as close to the Vin pin as possible. )

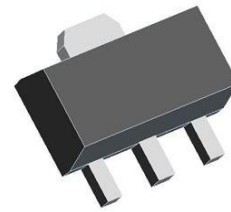

**SOT-89**

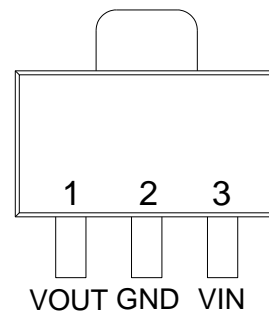

**Pin Configuration (Top View)**

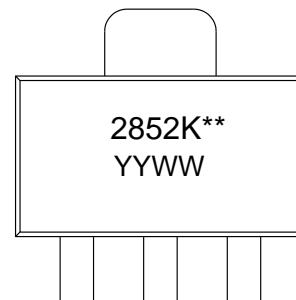

For detail marking information, please see page 10.

**Marking**

### Order Information

For detail order information, please see page 10.

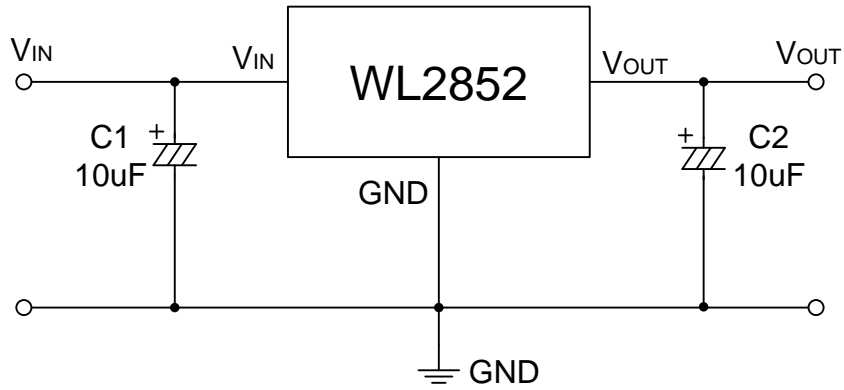
**Typical Application**

**Pin Description**

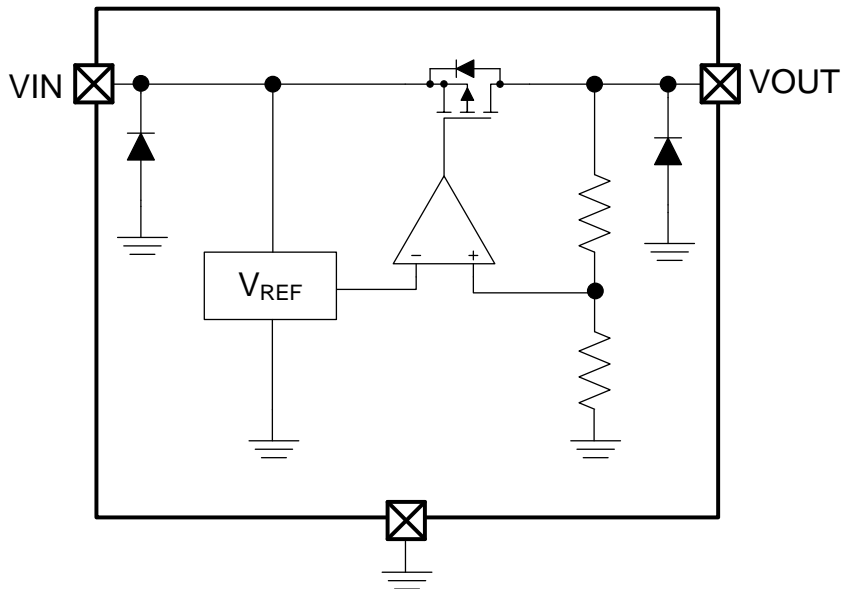
PIN	Symbol	Description
1	VOUT	Voltage Output
2	GND	Ground
3	VIN	Voltage Input

**Block Diagram**

**Absolute Maximum Ratings**

Parameter	Value	Unit
Power Dissipation	Internal limited	mW
V <sub>IN</sub> Range	-0.3~45	V
V <sub>OUT</sub> Range	-0.3~6.5	V
Lead Temperature Range	260	°C
Storage Temperature Range	-55 ~ 150	°C
Operating Junction Temperature Range	150	°C
ESD MM	400	V
ESD HBM	4K	V

**Recommend Operating Ratings**

Parameter	Value	Unit
Operating Supply voltage	4.75~40	V
Operating Temperature Range	-40~85	°C
Thermal Resistance (On PCB) , R <sub>θJA</sub>	43.5	°C/W
Power Dissipation	1000	mW

**Electronics Characteristics (Ta=25°C, V<sub>IN</sub>=12V, C<sub>IN</sub>=C<sub>OUT</sub>=10uF, unless otherwise noted)**

Symbol	Parameter	Test Condition	WL2852K SPEC			Unit
			Min.	Typ.	Max.	
V <sub>IN</sub>	Input Range	I <sub>OUT</sub> =10mA	4.75		40	V
V <sub>OUT</sub>	Output Range	I <sub>OUT</sub> =10mA	V <sub>OUT</sub> *0.98	V <sub>OUT</sub>	V <sub>OUT</sub> *1.02	V
ΔV <sub>OUT</sub>	Output Voltage	V <sub>IN</sub> =12V, I <sub>OUT</sub> =10mA	5.586	5.7	5.814	V
			5.194	5.3	5.406	V
			4.9	5.0	5.1	V
			4.312	4.4	4.488	V
			3.920	4.0	4.080	V
			3.528	3.6	3.672	V
			3.234	3.3	3.366	V
I <sub>OUT_PK</sub>	Maximum Output Current	V <sub>IN</sub> =12V, R <sub>L</sub> =1Ω	180	280	460	mA
I <sub>Q</sub>	Quiescent Current	V <sub>IN</sub> =7V, No load		10	15	μA
		V <sub>IN</sub> =24V, No load		11	16	
		V <sub>IN</sub> =40V, No load		13	20	
V <sub>DROP</sub>	Dropout Voltage	I <sub>OUT</sub> =1mA		8	12	mV
		I <sub>OUT</sub> =100mA		800	1200	
Δ V <sub>Line</sub>	Line Regulation	V <sub>IN</sub> =7--24V, V <sub>OUT</sub> =5V I <sub>OUT</sub> =1mA		0.02		%V
		V <sub>IN</sub> =7--45V, V <sub>OUT</sub> =5V I <sub>OUT</sub> =1mA		0.1		
Δ V <sub>Load</sub>	Load Regulation	V <sub>IN</sub> =12V, I <sub>OUT</sub> =1--100mA		0.6		%
e <sub>NO</sub>	Output Noise	I <sub>OUT</sub> =10mA	-100		+100	μV
PSRR	Ripple Rejection	V <sub>IN</sub> =10V	f=100Hz	60		dB
		V <sub>PP</sub> =0.5V	f=1KHz	45		
		I <sub>OUT</sub> =1mA	f=10KHz	35		
T <sub>SD</sub>	Thermal Protection	V <sub>IN</sub> =12V, I <sub>OUT</sub> =1mA		165		°C
T <sub>SD_HYS</sub>	Thermal Protection Hys	V <sub>IN</sub> =12V, I <sub>OUT</sub> =1mA		30		°C
ΔVo/ΔT	Temperature Coefficient	V <sub>IN</sub> =12V, I <sub>OUT</sub> =1mA		±0.5		mv/°C

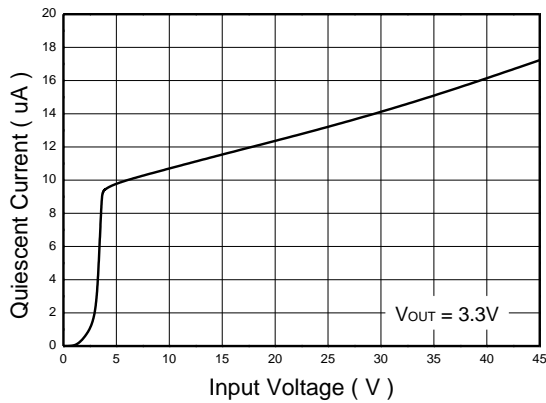
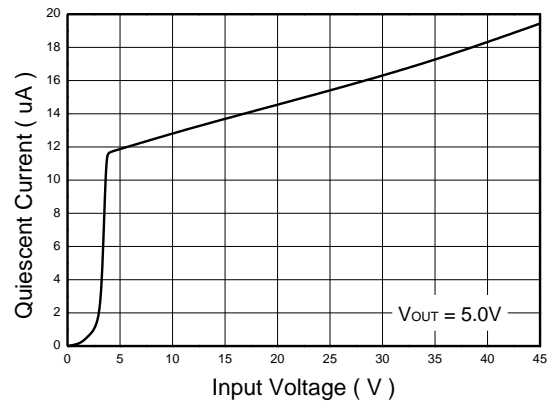
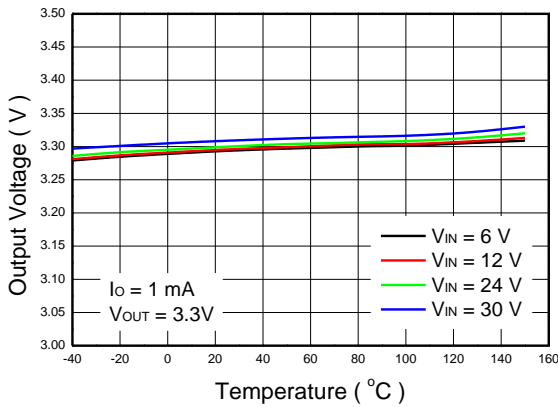
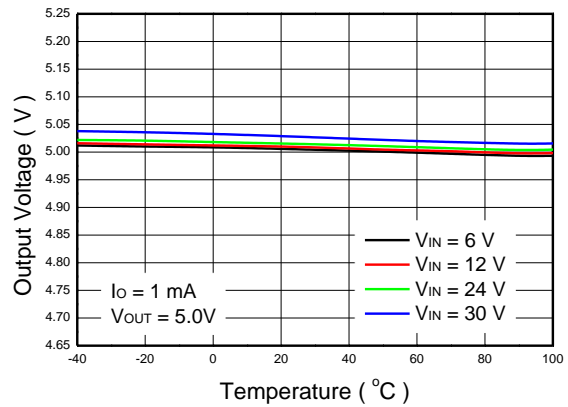
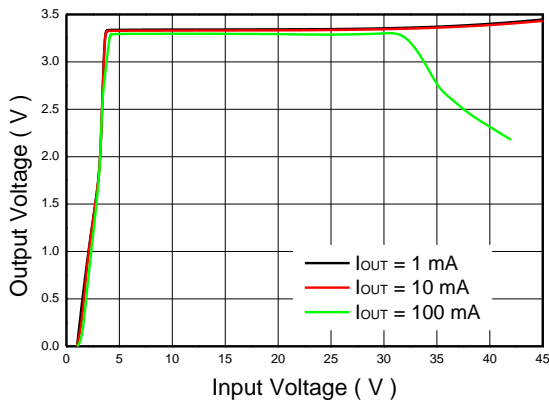
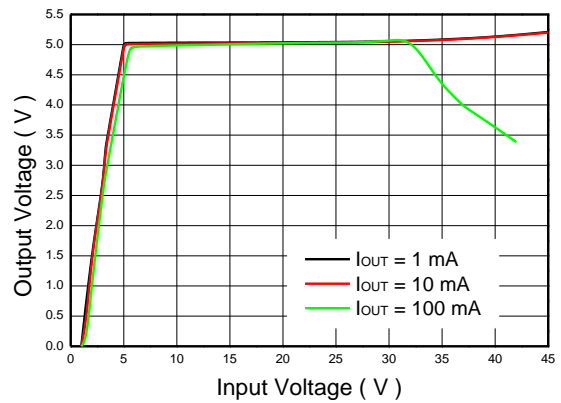
**Typical characteristics (Ta=25oC, CIN=COUT=10uF, unless otherwise noted)**

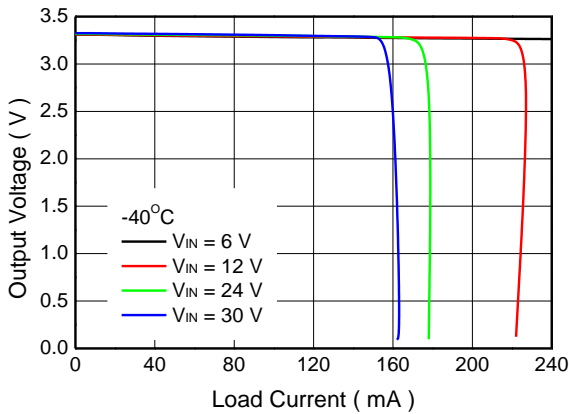
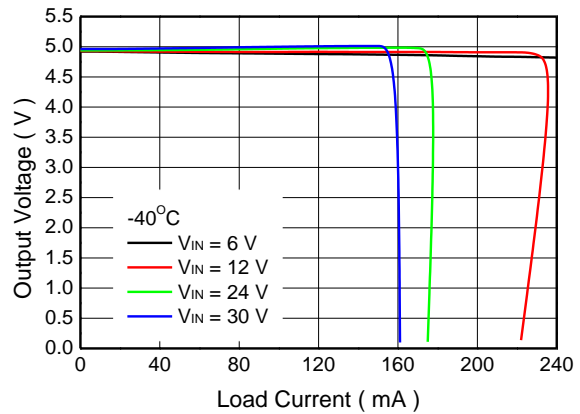
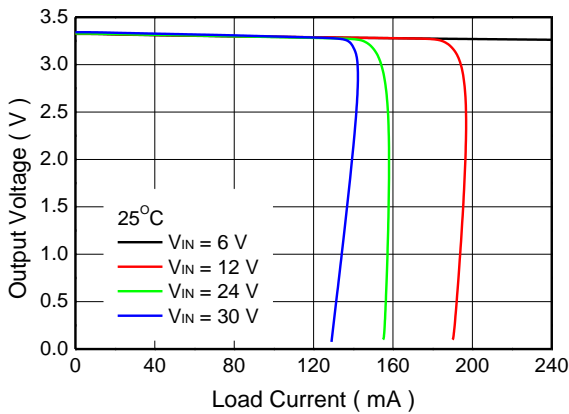
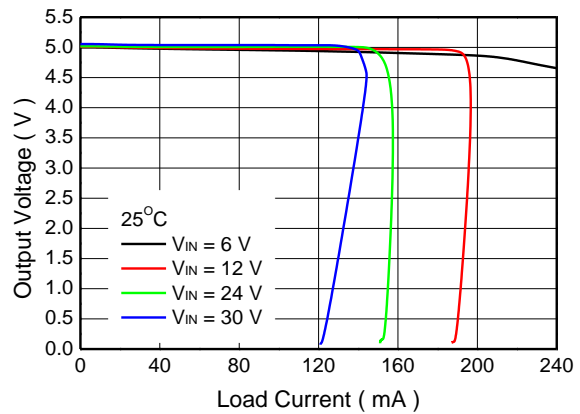
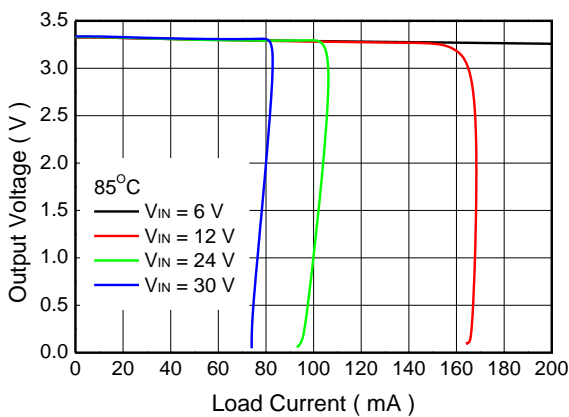
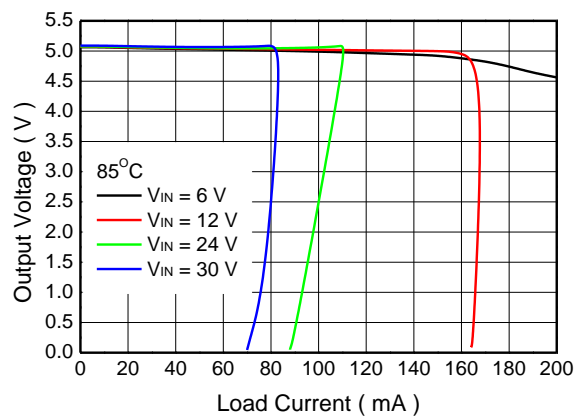
**Quiescent Current vs. Input Voltage**

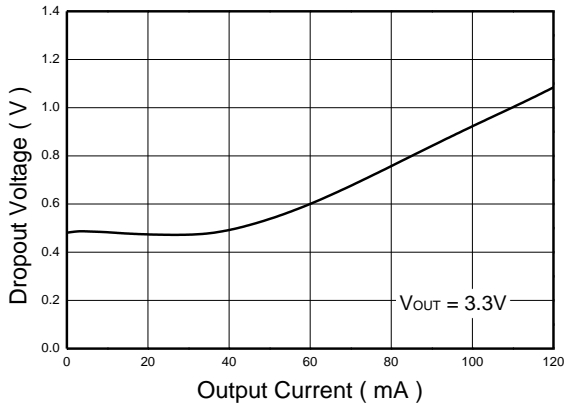
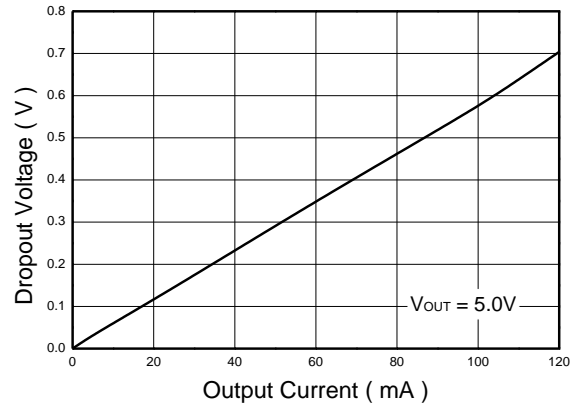
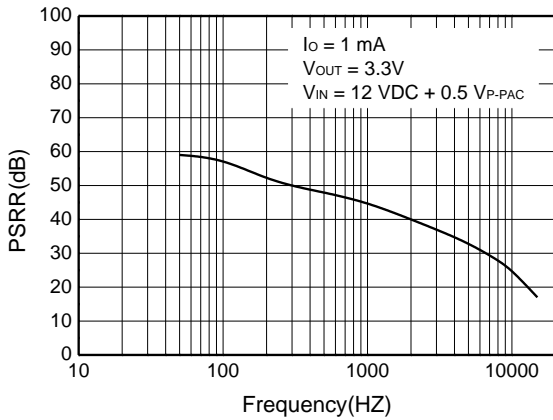
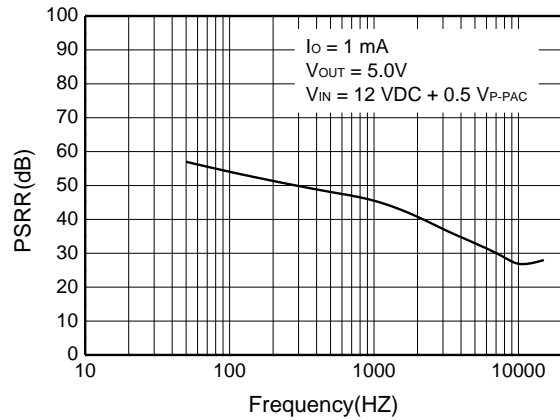
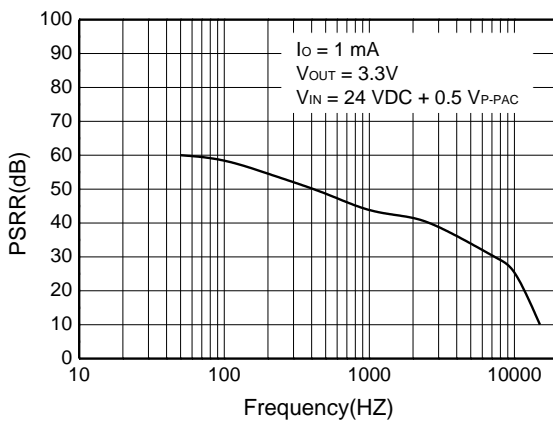
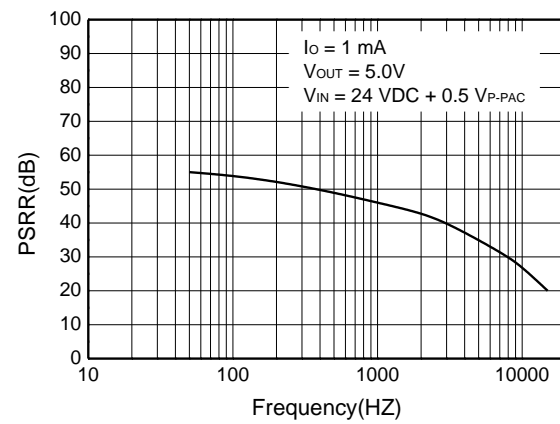
**Quiescent Current vs. Input Voltage**

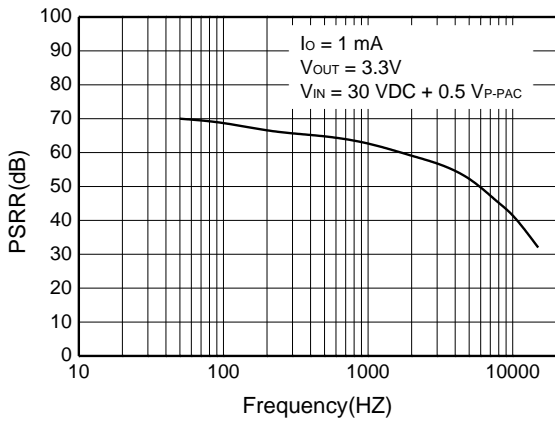
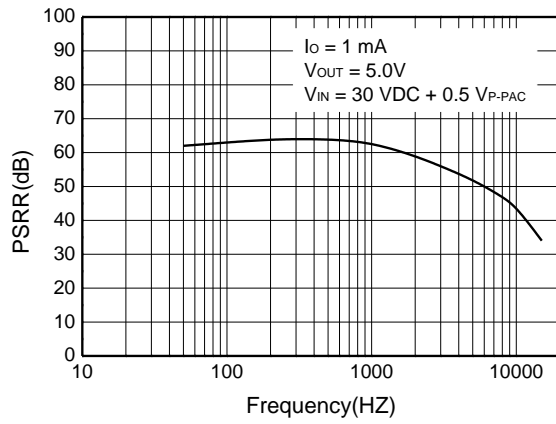
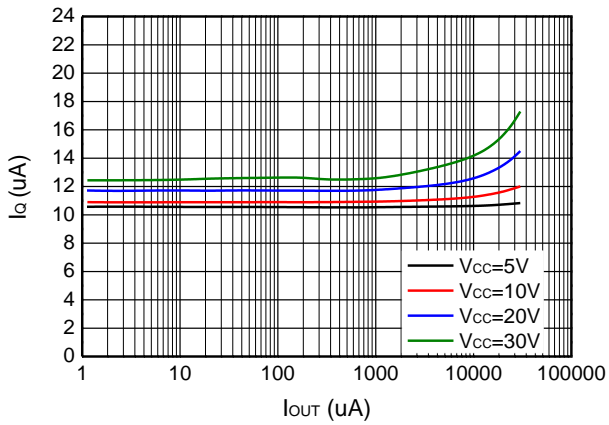
**Output Voltage vs. Temperature**

**Output Voltage vs. Temperature**

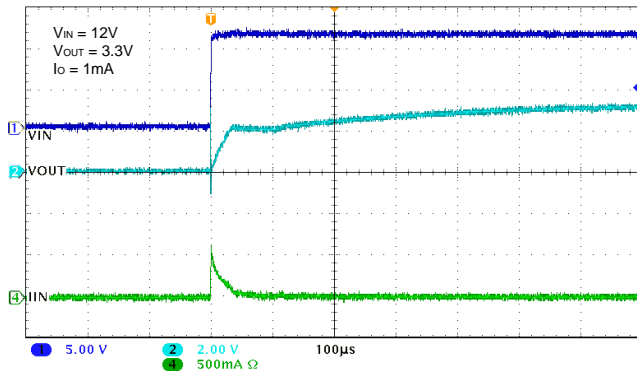
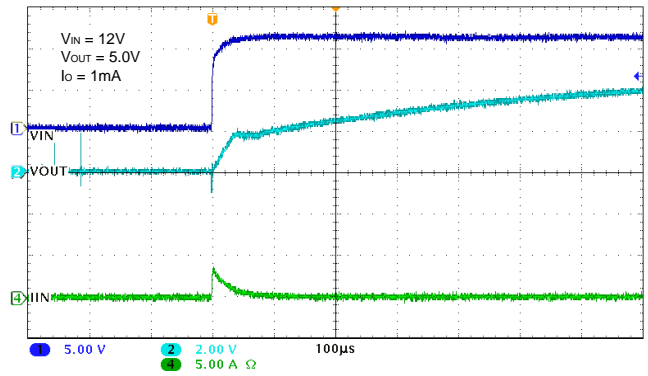
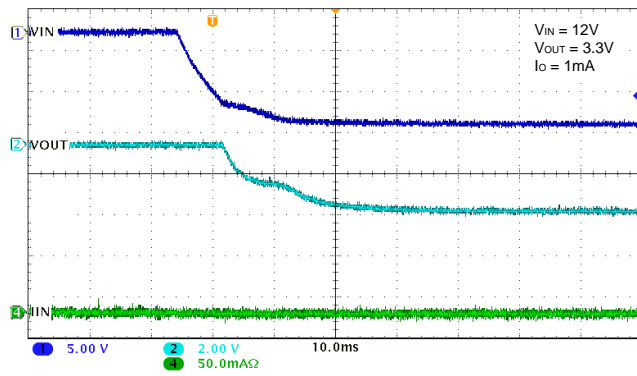
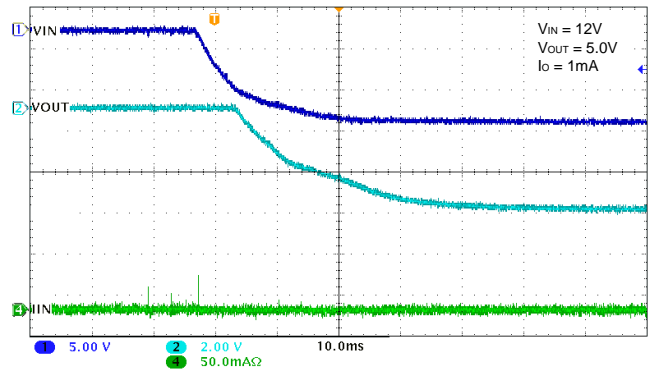
**Output Voltage vs. Input Voltage**

**Output Voltage vs. Input Voltage**

**Output Voltage vs. Load Current**

**Output Voltage vs. Load Current**

**Output Voltage vs. Load Current**

**Output Voltage vs. Load Current**

**Output Voltage vs. Load Current**

**Output Voltage vs. Load Current**

**Dropout Voltage vs. Output Current**

**Dropout Voltage vs. Output Current**

**PSRR vs. Frequency**

**PSRR vs. Frequency**

**PSRR vs. Frequency**

**PSRR vs. Frequency**

**PSRR vs. Frequency**

**PSRR vs. Frequency**

**Quiescent Current vs. Output Current**



**Startup from Power ON**

**Startup from Power ON**

**Shutdown from Power OFF**

**Shutdown from Power OFF**

**ORDER INFORMATION**

Ordering No.	Vout (V)	Package	Operating Temperature	Marking	Shipping
WL2852K33-3/TR	3.3	SOT-89	-40~+85°C	2852KDD YYWW	Tape and Reel, 1000
WL2852K36-3/TR	3.6	SOT-89	-40~+85°C	2852KDG YYWW	Tape and Reel, 1000
WL2852K40-3/TR	4.0	SOT-89	-40~+85°C	2852KEA YYWW	Tape and Reel, 1000
WL2852K44-3/TR	4.4	SOT-89	-40~+85°C	2852KEE YYWW	Tape and Reel, 1000
WL2852K50-3/TR	5.0	SOT-89	-40~+85°C	2852KFA YYWW	Tape and Reel, 1000
WL2852K53-3/TR	5.3	SOT-89	-40~+85°C	2852KFD YYWW	Tape and Reel, 1000
WL2852K57-3/TR	5.7	SOT-89	-40~+85°C	2852KFH YYWW	Tape and Reel, 1000

**Marking:**

2852K\*\* = Device Code

YY = Year

WW = Week

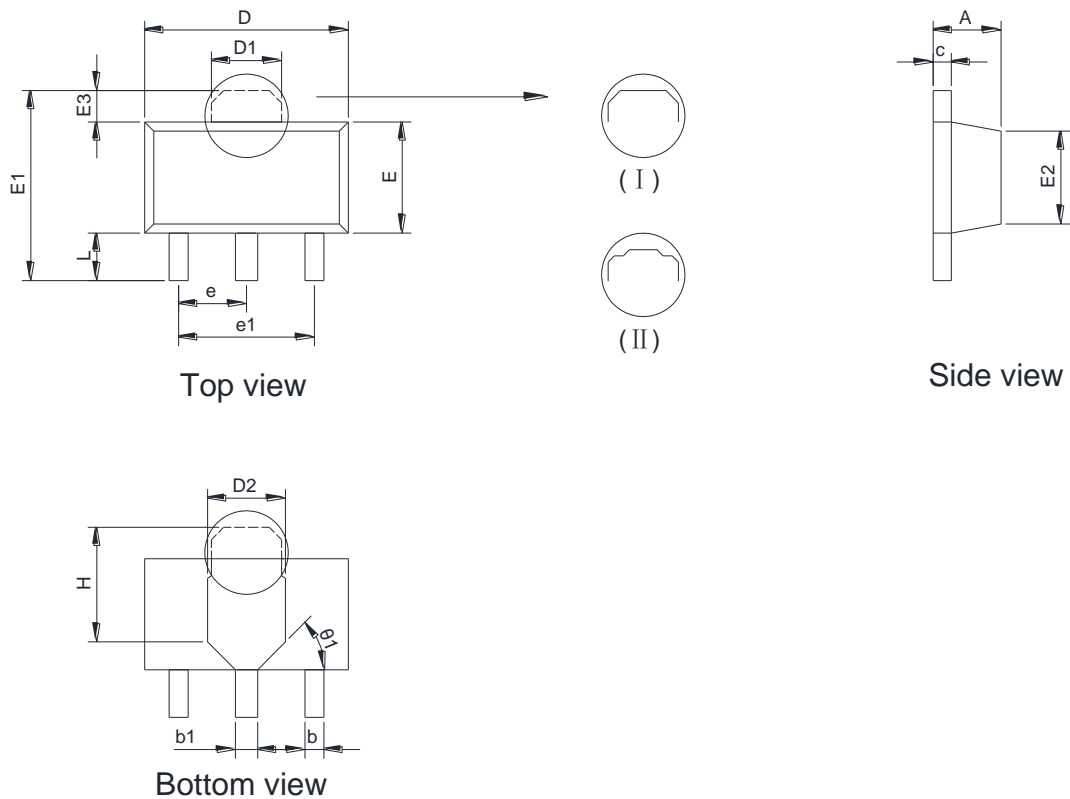
**Package outline dimensions**
**SOT-89-3L**

Symbol	Dimensions in millimeters	
	Min.	Max.
A	1.400	1.600
b	0.320	0.520
b 1	0.400	0.580
c	0.350	0.440
D	4.400	4.600
D1	1.550	1.800
D2	1.600	1.900
E	2.300	2.600
E1	3.940	4.250
E2	1.940	2.290
E3	0.600	0.800
H	2.700	3.000
e	1.500TYP	
e 1	3.000TYP	
L	0.890	1.200
$\theta$ 1	45°	

**TAPE AND REEL INFORMATION**

Reel Dimensions

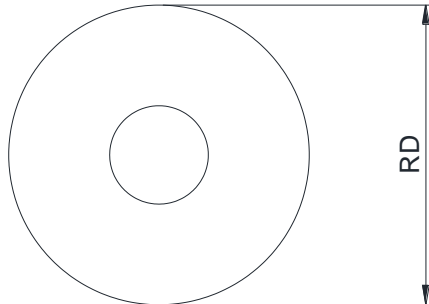

Tape Dimensions

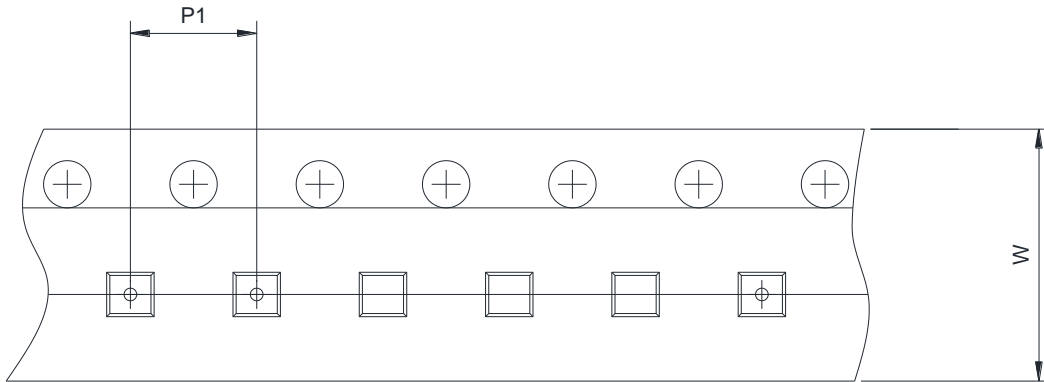

Quadrant Assignments For PIN1 Orientation In Tape

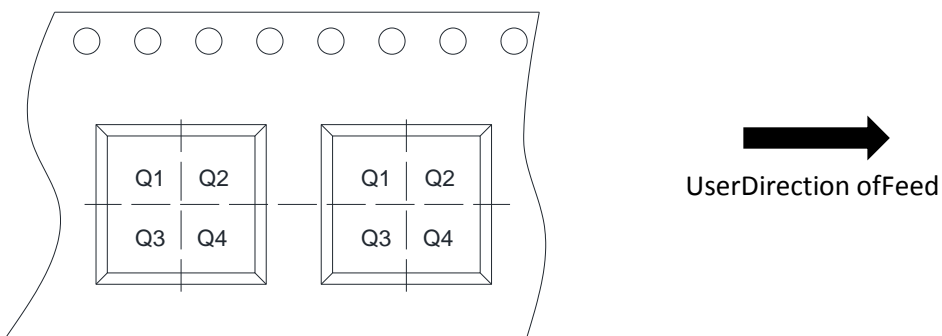

RD	Reel Dimension	<input checked="" type="checkbox"/> 7 inch <input type="checkbox"/> 13 inch
P1	Pitch between successive cavity centers	<input type="checkbox"/> 2 mm <input type="checkbox"/> 4 mm <input checked="" type="checkbox"/> 8 mm
W	Overall width of the carrier tape	<input type="checkbox"/> 8 mm <input checked="" type="checkbox"/> 12 mm
Pin1	Pin1 Quadrant	<input type="checkbox"/> Q1 <input type="checkbox"/> Q2 <input type="checkbox"/> Q3 <input type="checkbox"/> Q4