

### CMOS System Reset IC with Delay Time Circuit Monolithic IC KIC72\*\* Series

In various CPU systems or other logic systems, when the time of a power supply injection and a power supply are severed for a moment, this IC detects supply voltage and applies reset to a system.

To 2% of detection voltage accuracy of the conventional product, a maximum of 1% of super-high precision is realized, and it is more suitable for battery detection etc.

#### FEATURES

- High accuracy :  $\pm 1\%$  MAX
- Super low supply current :  $0.35\mu\text{A}$  typ.
- Operating-temperature range :  $-40\sim+105^\circ\text{C}$
- Delay resistance accuracy :  $10\text{M}\Omega \pm 10\%$
- Detecting voltage rank :  $0.8\sim 6.0\text{V}$  (0.1V step)
- Output Configuration : CMOS output

#### Applications

- Reset circuits for CPUs and MPUs
- Reset circuits for logic circuits
- Battery voltage check circuits
- Back-up power supply switching circuits
- Level detection circuits

#### Pin Configuration

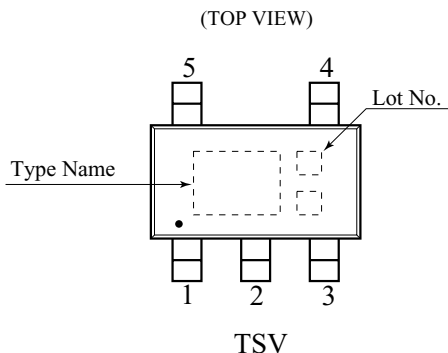

#### Pin Description

Pin No.	Pin name	Functions
1	$V_{\text{OUT}}$	Reset Signal Output Pin
2	$V_{\text{DD}}$	$V_{\text{DD}}$ Pin / Voltage Detect Pin
3	GND	GND Pin
4	NC	No Connection
5	$C_{\text{D}}$	Capacitor Connect Pin with Delay

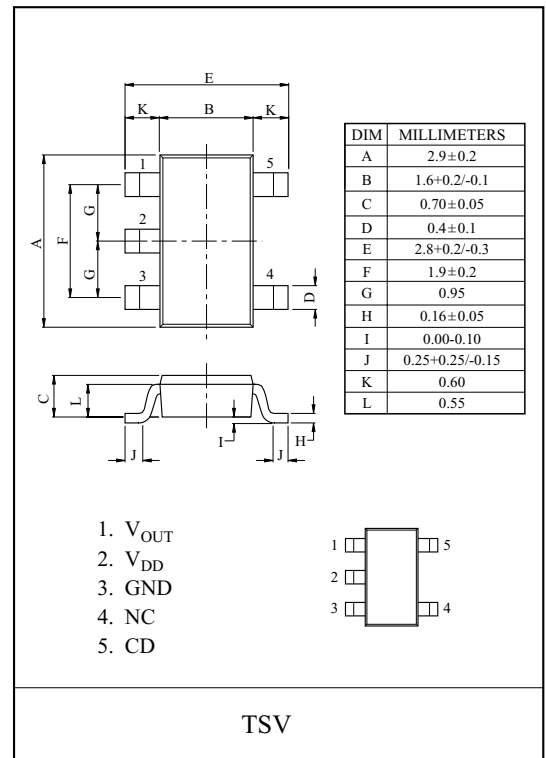

# KIC7208~7260T5

## Block Diagram

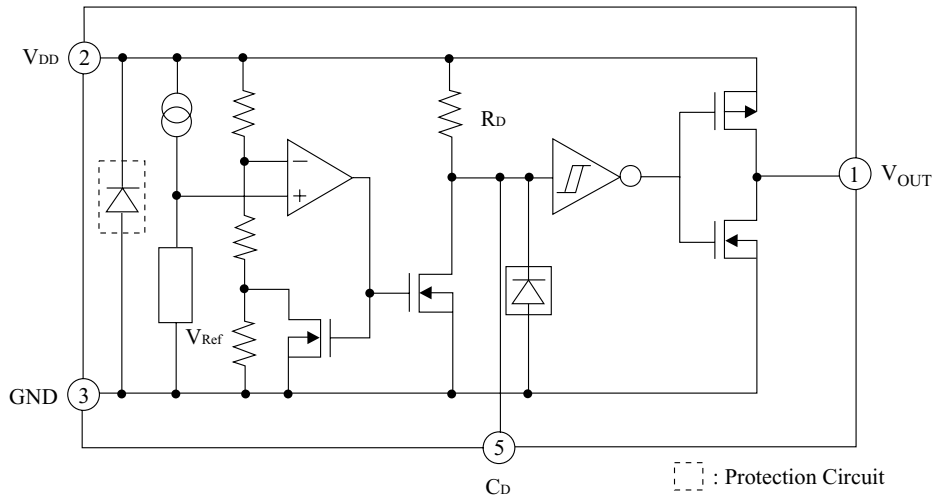

Figure. 1

## Selection Guide

The Output voltage, package type for the ICs can be selected at the user's request.

The selection can be made with designating the part number as shown below

**KIC7** 2 □□ □  
 ①            ②            ③

NO.	Specifications	Description
①	Function & Output Type	External Reset, CMOSOutput
②	Reset Voltage	0.8~6.0V
③	Package	T5

# KIC7208~7260T5

## Absolute maximum ratings(Ta=25℃)

ITEM	SYMBOL	RATINGS	UNITS
Supply voltage	V <sub>DD MAX.</sub>	-0.3 ~ +12.0	V
Output voltage	V <sub>OUT</sub>	-0.3 ~ (V <sub>DD</sub> +0.3)	V
Input current (V <sub>DD</sub> )	I <sub>DD</sub>	20	mA
Output current ( RESET )	I <sub>OUT</sub>	20	mA
C <sub>D</sub> pin Input voltage	V <sub>CD</sub>	V <sub>SS</sub> -0.3 ~ +12.0	V
Power dissipation	P <sub>D</sub>	900 □Note)	mW
Operating temperature	T <sub>OPR</sub>	-40~+105	℃
Storage temperature	T <sub>STG</sub>	-65~+150	℃

□Note) Package Mounted on a Ceramic board (600mm<sup>2</sup>×0.8mm)

## Recommended Operating Conditions

ITEM	SYMBOL	RATINGS	UNITS
Operating Temperature	T <sub>opr</sub>	-40 ~ +105	℃
Supply voltage	V <sub>DD</sub>	0.70~10.0	V

# KIC7208~7260T5

## Line-up

Detecting Voltage	KIC7208~25T5		Detecting Voltage	KIC7226~43T5		Detecting Voltage	KIC7244~60T5	
	Item	Marking		Item	Marking		Item	Marking
0.8V	KIC7208T5	208	2.6V	KIC7226T5	226	4.4V	KIC7244T5	244
0.9V	KIC7209T5	209	2.7V	KIC7227T5	227	4.5V	KIC7245T5	245
1.0V	KIC7210T5	210	2.8V	KIC7228T5	228	4.6V	KIC7246T5	246
1.1V	KIC7211T5	211	2.9V	KIC7229T5	229	4.7V	KIC7247T5	247
1.2V	KIC7212T5	212	3.0V	KIC7230T5	230	4.8V	KIC7248T5	248
1.3V	KIC7213T5	213	3.1V	KIC7231T5	231	4.9V	KIC7249T5	249
1.4V	KIC7214T5	214	3.2V	KIC7232T5	232	5.0V	KIC7250T5	250
1.5V	KIC7215T5	215	3.3V	KIC7233T5	233	5.1V	KIC7251T5	251
1.6V	KIC7216T5	216	3.4V	KIC7234T5	234	5.2V	KIC7252T5	252
1.7V	KIC7217T5	217	3.5V	KIC7235T5	235	5.3V	KIC7253T5	253
1.8V	KIC7218T5	218	3.6V	KIC7236T5	236	5.4V	KIC7254T5	254
1.9V	KIC7219T5	219	3.7V	KIC7237T5	237	5.5V	KIC7255T5	255
2.0V	KIC7220T5	220	3.8V	KIC7238T5	238	5.6V	KIC7256T5	256
2.1V	KIC7221T5	221	3.9V	KIC7239T5	239	5.7V	KIC7257T5	257
2.2V	KIC7222T5	222	4.0V	KIC7240T5	240	5.8V	KIC7258T5	258
2.3V	KIC7223T5	223	4.1V	KIC7241T5	241	5.9V	KIC7259T5	259
2.4V	KIC7224T5	224	4.2V	KIC7242T5	242	6.0V	KIC7260T5	260
2.5V	KIC7225T5	225	4.3V	KIC7243T5	243			

# KIC7208~7260T5

## Electrical characteristics (Unless Otherwise Specified Ta=25°C)

ITEM	SYMBOL	MEASUREMENT CONDITIONS	RANK	MIN.	TYP.	MAX.	UNITS	CIRCUIT
Reset Threshold	$V_{TH}$	Ta = +25°C Ta = -40~+85°C	7208	0.792	0.8	0.808	V	(2)
				0.780	-	0.820		
			7209	0.891	0.9	0.909		
				0.878	-	0.923		
			7210	0.990	1.0	1.010		
				0.975	-	1.025		
			7211	1.089	1.1	1.111		
				1.073	-	1.128		
			7212	1.188	1.2	1.212		
				1.170	-	1.230		
			7213	1.287	1.3	1.313		
				1.268	-	1.333		
			7214	1.386	1.4	1.414		
				1.365	-	1.435		
			7215	1.485	1.5	1.515		
				1.463	-	1.538		
			7216	1.584	1.6	1.616		
				1.560	-	1.640		
			7217	1.683	1.7	1.717		
				1.658	-	1.743		
			7218	1.782	1.8	1.818		
				1.755	-	1.845		
			7219	1.881	1.9	1.919		
				1.853	-	1.948		
			7220	1.980	2.0	2.020		
				1.950	-	2.050		
			7221	2.079	2.1	2.121		
				2.048	-	2.153		
			7222	2.178	2.2	2.222		
				2.145	-	2.255		
7223	2.277	2.3	2.323					
	2.243	-	2.358					
7224	2.376	2.4	2.424					
	2.340	-	2.460					
7225	2.475	2.5	2.525					
	2.438	-	2.563					
7226	2.574	2.6	2.626					
	2.535	-	2.665					
7227	2.673	2.7	2.727					
	2.633	-	2.768					
7228	2.772	2.8	2.828					
	2.730	-	2.870					
7229	2.871	2.9	2.929					
	2.828	-	2.973					
7230	2.970	3.0	3.030					
	2.925	-	3.075					

# KIC7208~7260T5

## Electrical characteristics (Unless Otherwise Specified Ta=25°C)

ITEM	SYMBOL	MEASUREMENT CONDITIONS	RANK	MIN.	TYP.	MAX.	UNITS	CIRCUIT
Reset Threshold	V <sub>TH</sub>	Ta = +25°C Ta = -40~+85°C	7231	3.069	3.1	3.131	V	(2)
				3.023	-	3.178		
			7232	3.168	3.2	3.232		
				3.120	-	3.280		
			7233	3.267	3.3	3.333		
				3.218	-	3.383		
			7234	3.366	3.4	3.434		
				3.315	-	3.485		
			7235	3.465	3.5	3.535		
				3.413	-	3.588		
			7236	3.564	3.6	3.636		
				3.510	-	3.690		
			7237	3.663	3.7	3.737		
				3.608	-	3.793		
			7238	3.762	3.8	3.838		
				3.705	-	3.895		
			7239	3.861	3.9	3.939		
				3.803	-	3.998		
			7240	3.960	4.0	4.040		
				3.900	-	4.100		
			7241	4.059	4.1	4.141		
				3.998	-	4.203		
			7242	4.158	4.2	4.242		
				4.095	-	4.305		
			7243	4.257	4.3	4.343		
				4.193	-	4.408		
			7244	4.356	4.4	4.444		
				4.290	-	4.510		
			7245	4.455	4.5	4.545		
				4.388	-	4.613		
			7246	4.554	4.6	4.646		
				4.485	-	4.715		
7247	4.653	4.7	4.747					
	4.583	-	4.818					
7248	4.752	4.8	4.848					
	4.680	-	4.920					
7249	4.851	4.9	4.949					
	4.778	-	5.023					
7250	4.950	5.0	5.050					
	4.875	-	5.125					
7251	5.049	5.1	5.151					
	4.973	-	5.228					
7252	5.148	5.2	5.252					
	5.070	-	5.330					
7253	5.247	5.3	5.353					
	5.168	-	5.433					

# KIC7208~7260T5

## Electrical characteristics (Unless Otherwise Specified Ta=25°C)

ITEM	SYMBOL	MEASUREMENT CONDITIONS	RANK	MIN.	TYP.	MAX.	UNITS	CIRCUIT					
Reset Threshold	$V_{TH}$	Ta = +25°C Ta = -40~+85°C	7254	5.346	5.4	5.454	V	(2)					
				5.265	-	5.535							
			7255	5.445	5.5	5.555							
				5.363	-	5.638							
			7256	5.544	5.6	5.656							
				5.460	-	5.740							
			7257	5.643	5.7	5.757							
				5.558	-	5.843							
			7258	5.742	5.8	5.858							
				5.655	-	5.945							
			7259	5.841	5.9	5.959							
				5.753	-	6.048							
			7260	5.940	6.0	6.060							
				5.850	-	6.150							
			Reset Threshold hysteresis	$\square V_{TH}$	$V_{DD}=0V \rightarrow V_{TH}+1V \rightarrow 0V$	7208			24	40	64	mV	(2)
						7209			27	45	72		
7210	30	50				80							
7211	33	55				88							
7212	36	60				96							
7213	39	65				104							
7214	42	70				112							
7215	45	75				120							
7216	48	80				128							
7217	51	85				136							
7218	54	90				144							
7219	57	95				152							
7220	60	100				160							
7221	63	105				168							
7222	66	110				176							
7223	69	115				184							
7224	72	120				192							
7225	75	125				200							
7226	78	130				208							
7227	81	135				216							
7228	84	140				224							
7229	87	145				232							
7230	90	150				240							
7231	93	155				248							
7232	96	160	256										
7233	99	165	264										
7234	102	170	272										
7235	105	175	280										
7236	108	180	288										
7237	111	185	296										
7238	114	190	304										
7239	117	195	312										
7240	120	200	320										

# KIC7208~7260T5

ITEM	SYMBOL	MEASUREMENT CONDITIONS	RANK	MIN.	TYP.	MAX.	UNITS	CIRCUIT
Reset Threshold hysteresis	$\square V_{TH}$	$V_{DD}=0V \rightarrow V_{TH}+1V \rightarrow 0V$	7241	123	205	328	mV	(2)
			7242	126	210	336		
			7243	129	215	344		
			7244	132	220	352		
			7245	135	225	360		
			7246	138	230	368		
			7247	141	235	376		
			7248	144	240	384		
			7249	147	245	392		
			7250	150	250	400		
			7251	153	255	408		
			7252	156	260	416		
			7253	159	265	424		
			7254	162	270	432		
			7255	165	275	440		
			7256	168	280	448		
7257	171	285	456					
7258	174	290	464					
7259	177	295	472					
7260	180	300	480					
Supply Current	$I_{DD}$	$V_{DD} = V_{TH} + 1V$	7208 ~7260	-	0.35	1.0	uA	(1)
Reset threshold temp. coefficient	$\square V_{TH}/^{\circ}C$	$T_a = -40 \sim 85^{\circ}C$	7208 ~7260	-	$\pm 100$	-	ppm/ $^{\circ}C$	(2)
“ L ” transfer delay time	$t_{PHL}$	$V_{DD}=V_{TH}+0.4V \rightarrow V_{TH}-0.4V$ (note)	7208 ~7260	2	15	100	us	(7)
“ H ” transfer delay time	$t_{PLH}$	$V_{DD}=V_{TH}-0.4V \rightarrow V_{TH}+0.4V$ (note)	7208 ~7260	2	15	100	us	(7)
“ L ” output current	$I_{OL1}$	$V_{DD}=0.7V, V_{DS}=0.05V$	7208 ~7260	0.01	0.10	-	mA	(3)
	$I_{OL2}$	$V_{DD}=1.2V, V_{DS}=0.5V, V_{TH} \square 1.3V$	7208 ~7260	0.23	2.00	-		
	$I_{OL3}$	$V_{DD}=2.4V, V_{DS}=0.5V, V_{TH} \square 2.5V$	7225 ~7260	1.60	8.00	-		
	$I_{OL4}$	$V_{DD}=3.6V, V_{DS}=0.5V, V_{TH} \square 3.7V$	7237 ~7260	3.20	12.0	-		
“ H ” output current	$I_{OH1}$	$V_{DD}=4.8V, V_{DS}=0.5V, V_{TH} \square 4.7V$	7208 ~7260	0.36	0.62	0.1	mA	(4)
	$I_{OH2}$	$V_{DD}=6.1V, V_{DS}=0.5V$		0.46	0.75			

Note) This parameter is guaranteed by design.



# KIC7208~7260T5

ITEM	SYMBOL	TEST CONDITIONS	RANK	MIN.	TYP.	MAX.	UNITS	CIRCUIT
C <sub>D</sub> pin resistance	R <sub>D</sub>	-	7208 ~7260	9	10	11	MΩ	(6)
C <sub>D</sub> pin threshold voltage	V <sub>TCD</sub>	V <sub>DD</sub> = V <sub>TH</sub> × 1.1V	7208 ~7260	V <sub>DD</sub> × 0.3	V <sub>DD</sub> × 0.5	V <sub>DD</sub> × 0.7	V	(5)
C <sub>D</sub> pin output current 1	I <sub>CD1</sub>	V <sub>DS</sub> = 0.1V V <sub>DD</sub> = 0.7V	7208 ~7260	2.0	30.0	-	uA	(6)
C <sub>D</sub> pin output current 2	I <sub>CD2</sub>	V <sub>DS</sub> = 0.5V V <sub>DD</sub> = 0.8V(Rank08 ~ 10) V <sub>DD</sub> = 1.0V(Rank11 ~ 15) V <sub>DD</sub> = 1.5V(Rank16 ~ 60)	7208 ~7210	10	100	-	uA	(6)
			7211 ~7215	50	200	-		
			7216 ~7260	200	800	-		

Note) This device is tested at Ta=25°C, over temperature limits guaranteed by design only

# KIC7208~7260T5

## Test circuits

(1)

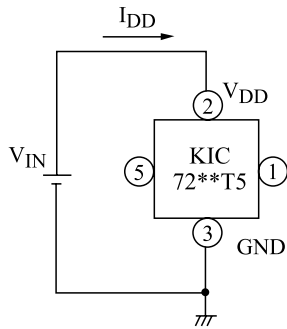

(2)

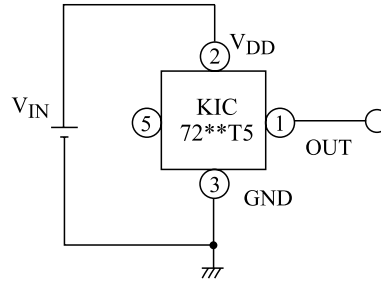

(3)

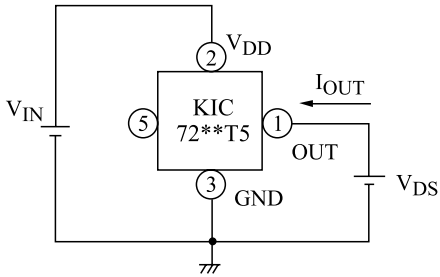

(4)

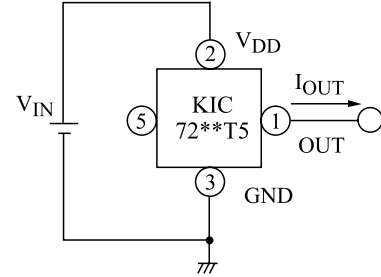

(5)

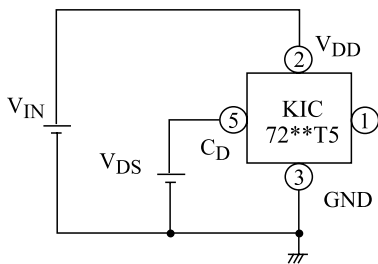

(6)

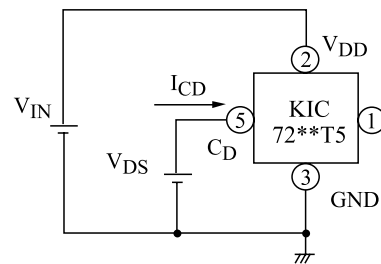

(7)

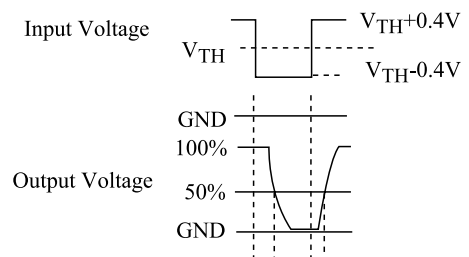
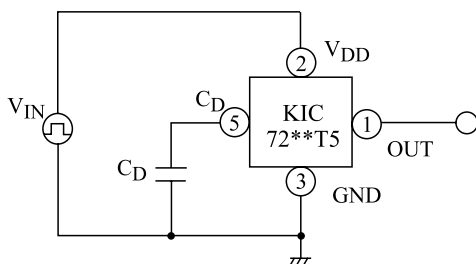

# KIC7208~7260T5

## Timing Chart

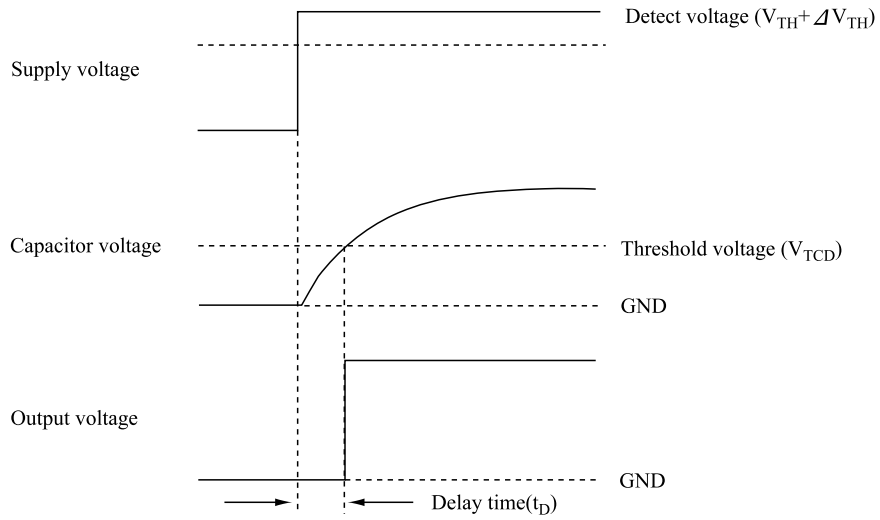

Delay time ( $t_D$ )

$$t_D \approx 0.69 \times R_D \times C_D \text{ (s)}$$

$R_D$  :  $C_D$  pin resistance  
 $C_D$  : Capacitor

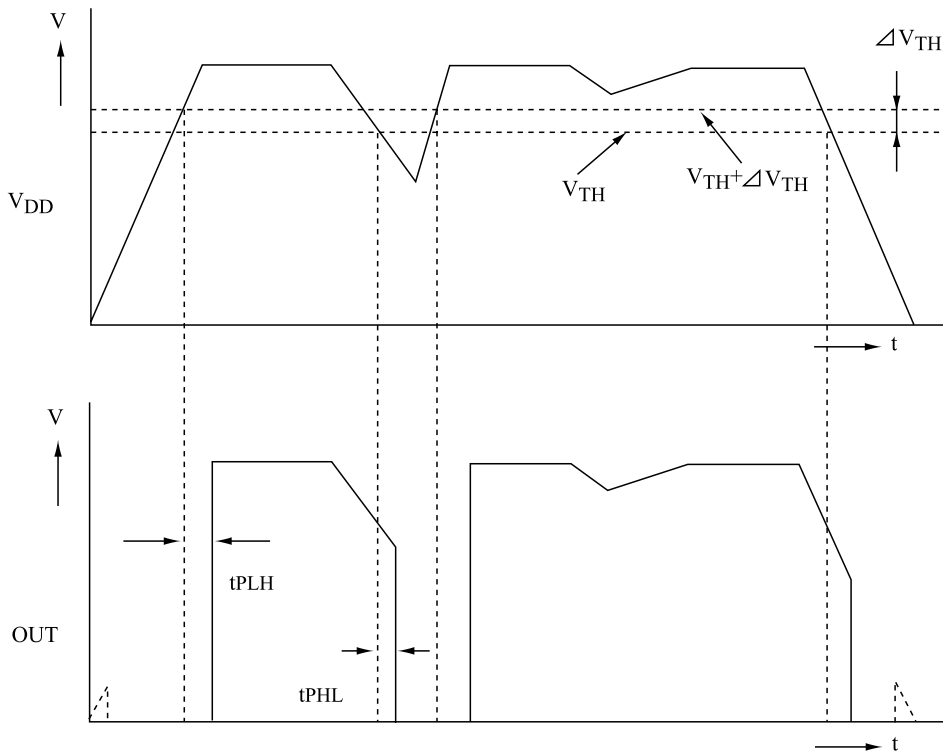

# KIC7208~7260T5

## Application Circuits

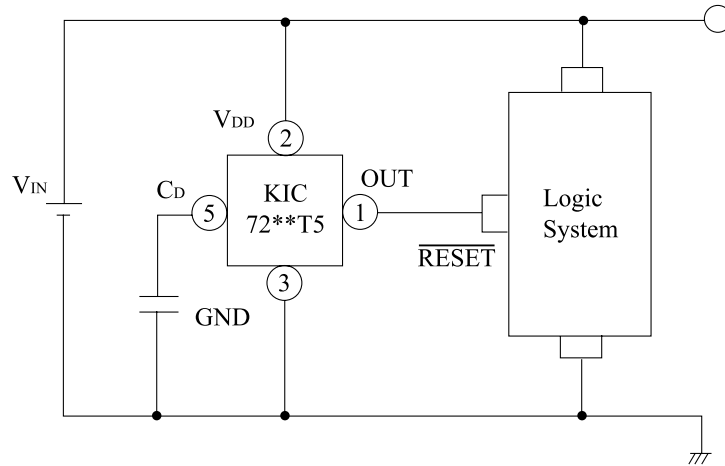

- We shall not be liable for any trouble or damage caused by using this circuit.
- In the event a problem which may affect industrial property or any other rights of us or a third party is encountered during the use of information described in these circuit, KEC shall not be liable for any such problem, nor grant a license therefore.

# KIC7208~7260T5

## Typical Characteristics (Typical performance Characteristics 2.9V)

note : These are typical characteristics

Fig1. Detecting Voltage

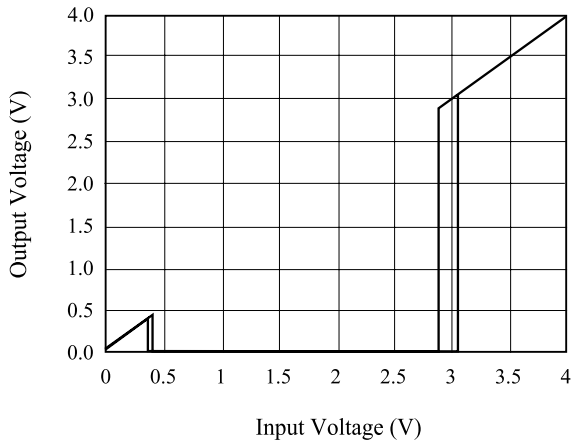

Fig2. Supply Current

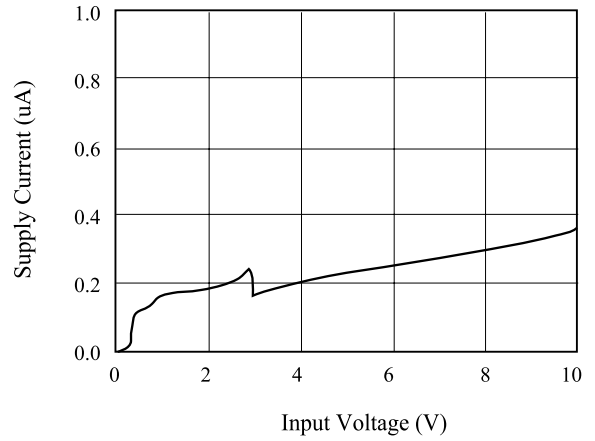

Fig3.  $C_D$  Pin Output Current

$V_{DS} = 0.5V$

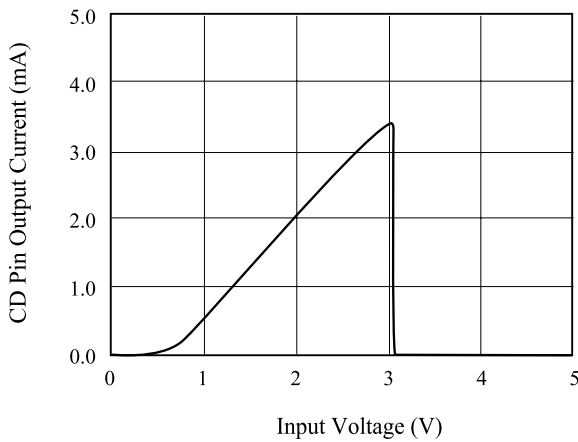

Fig4. Delay Time vs  $C_D$

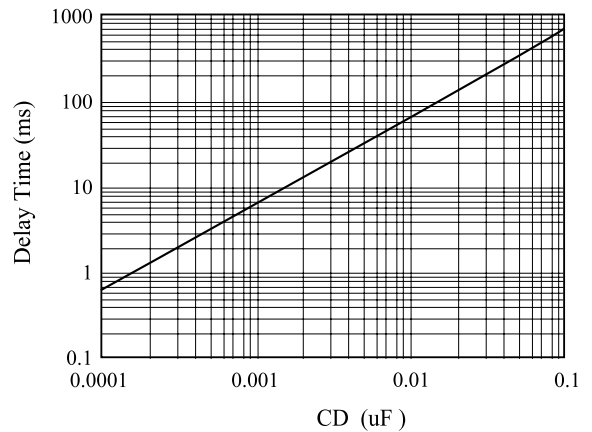

Fig5. Detecting Voltage vs Temperature

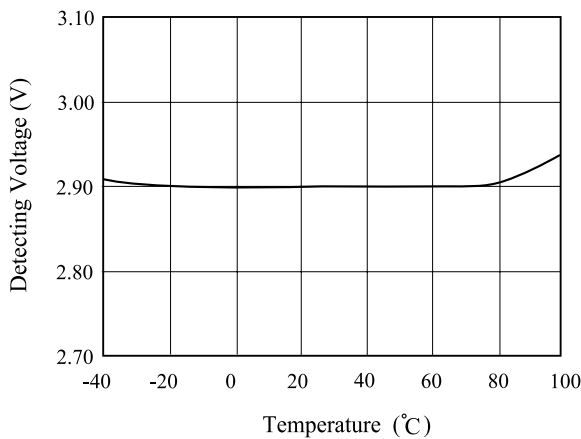
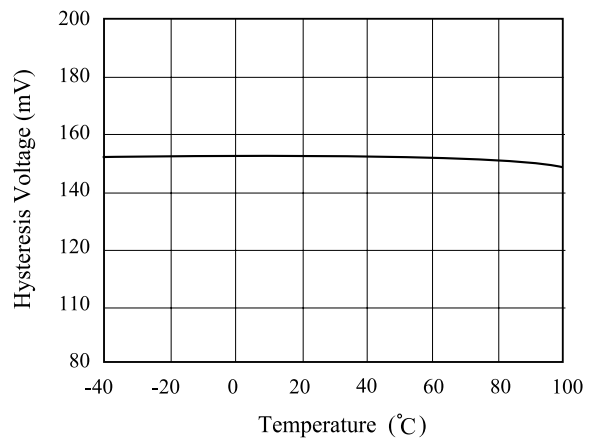

Fig6. Hysteresis Voltage vs Temperature



# KIC7208~7260T5

Fig7. "L" Output Current 1 vs Temperature

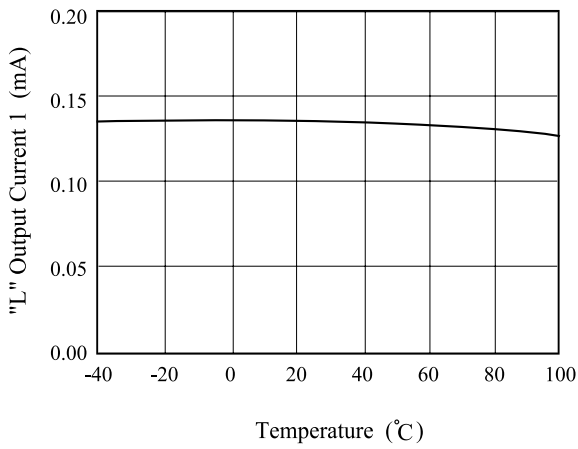

Fig8. "L" Output Current 2 vs Temperature

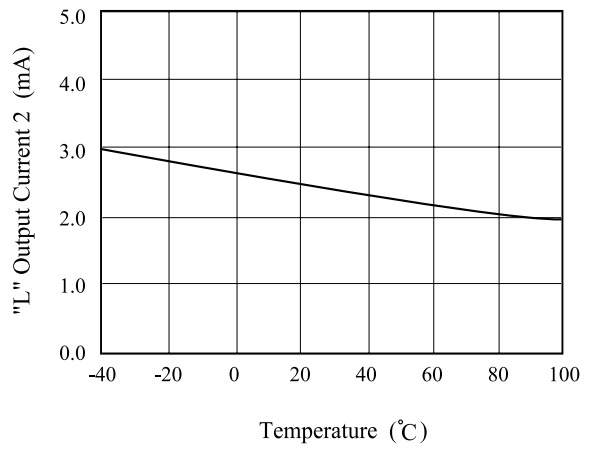

Fig9. "L" Output Current 3 vs Temperature

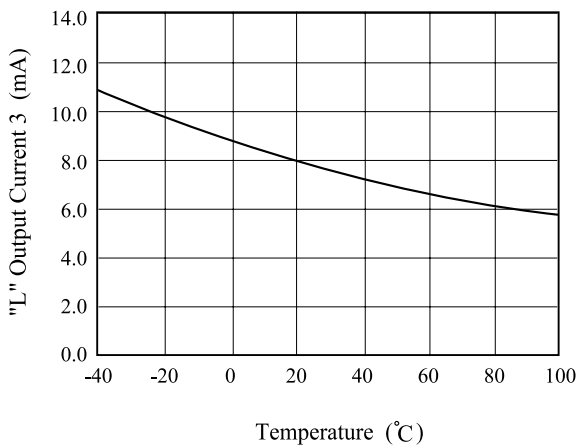

Fig10. C<sub>D</sub> Pin Threshold Voltage vs Temperature

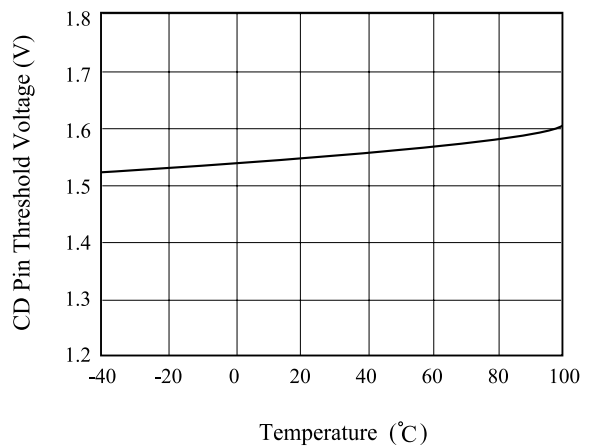

Fig11. C<sub>D</sub> Pin Output Current 1 vs Temperature

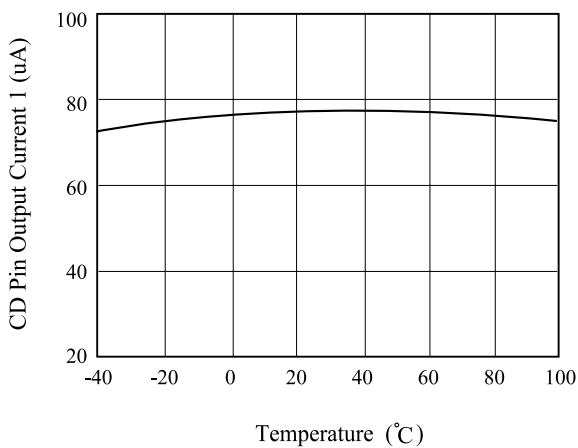

Fig12. C<sub>D</sub> Pin Output Current 2 vs Temperature

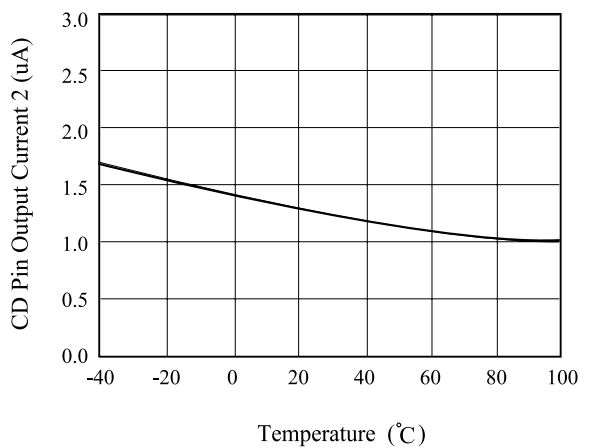
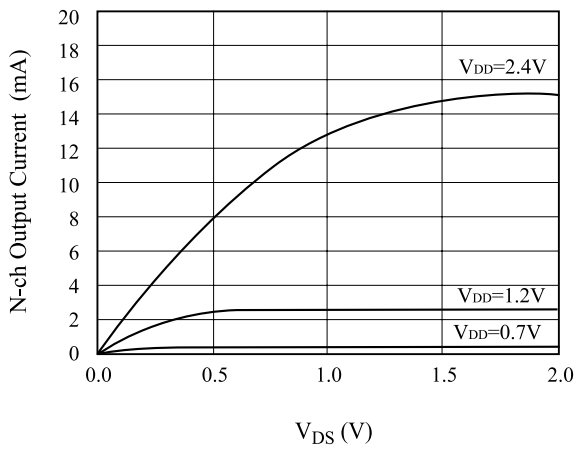

Fig13. N-ch Output Current



magnify

