



Micro Commercial Components



Micro Commercial Components
 20736 Marilla Street Chatsworth
 CA 91311
 Phone: (818) 701-4933
 Fax: (818) 701-4939

ES1AE THRU ES1ME

Features

- Lead Free Finish/Rohs Compliant (Note1) ("P" Suffix designates Compliant. See ordering information)
- Epoxy meets UL 94 V-0 flammability rating
- Moisture Sensitivity Level 1
- High Temp Soldering: 260°C for 10 Seconds At Terminals
- Superfast Recovery Times For High Efficiency
- Halogen free available upon request by adding suffix "-HF"

**1 Amp Ultra Fast
Recovery
Silicon Rectifier
50 to 1000 Volts**

Maximum Ratings

- Operating Temperature: -50°C to +150°C
- Storage Temperature: -50°C to +150°C
- Maximum Thermal Resistance; 15°C/W Junction To Lead

| MCC Part Number | Device Marking | Maximum Recurrent Peak Reverse Voltage | Maximum RMS Voltage | Maximum DC Blocking Voltage |
|-----------------|----------------|--|---------------------|-----------------------------|
| ES1AE | ES1A | 50V | 35V | 50V |
| ES1BE | ES1B | 100V | 70V | 100V |
| ES1CE | ES1C | 150V | 105V | 150V |
| ES1DE | ES1D | 200V | 140V | 200V |
| ES1GE | ES1G | 400V | 280V | 400V |
| ES1JE | ES1J | 600V | 420V | 600V |
| ES1KE | ES1K | 800V | 560V | 800V |
| ES1ME | ES1M | 1000V | 700V | 1000V |

DO-214AC (SMAE)

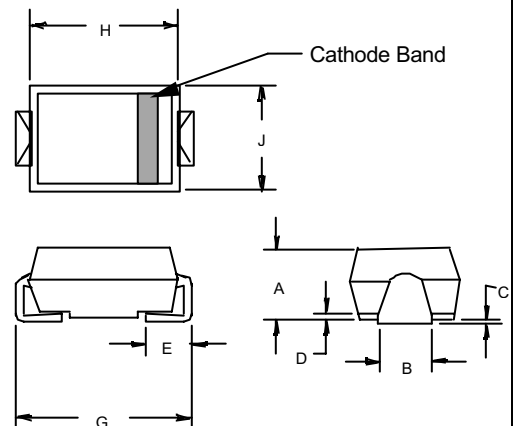

Electrical Characteristics @ 25°C Unless Otherwise Specified

| | | | |
|---|-------------|---|---|
| Average Forward Current | $I_{F(AV)}$ | 1.0A | $T_J = 75^\circ\text{C}$ |
| Peak Forward Surge Current | I_{FSM} | 30A | 8.3ms, half sine |
| Maximum Instantaneous Forward Voltage | V_F | ES1AE-DE: .975V ES1GE-JE: 1.35V ES1KE~ME: 1.70V | $I_{FM} = 1.0A$; $T_J = 25^\circ\text{C}^*$ |
| Maximum DC Reverse Current At Rated DC Blocking Voltage | I_R | 5 μA 100 μA | $T_J = 25^\circ\text{C}$ $T_J = 100^\circ\text{C}$ |
| Maximum Reverse Recovery Time | T_{rr} | ES1AE-DE: 50ns ES1GE-KE: 75ns ES1ME: 100ns | $I_F = 0.5A$, $I_R = 1.0A$, $I_{rr} = 0.25A$ |
| Typical Junction Capacitance | C_J | 45pF | Measured at 1.0MHz, $V_R = 4.0V$ |

| DIM | INCHES | | MM | | NOTE |
|-----|--------|------|------|------|------|
| | MIN | MAX | MIN | MAX | |
| A | .079 | .096 | 2.01 | 2.44 | |
| B | .050 | .075 | 1.27 | 1.90 | |
| C | .002 | .008 | .05 | .20 | |
| D | — | .02 | — | .51 | |
| E | .030 | .060 | .76 | 1.52 | |
| G | .189 | .208 | 4.80 | 5.30 | |
| H | .157 | .180 | 4.00 | 4.57 | |
| J | .090 | .115 | 2.29 | 2.92 | |

SUGGESTED SOLDER PAD LAYOUT

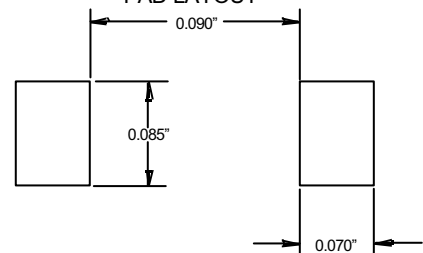

*Pulse test: Pulse width 200 μsec , Duty cycle 2%

Note: 1. High Temperature Solder Exemptions Applied, see EU Directive Annex 7.

ES1AE thru ES1ME

Figure 1
Typical Forward Characteristics

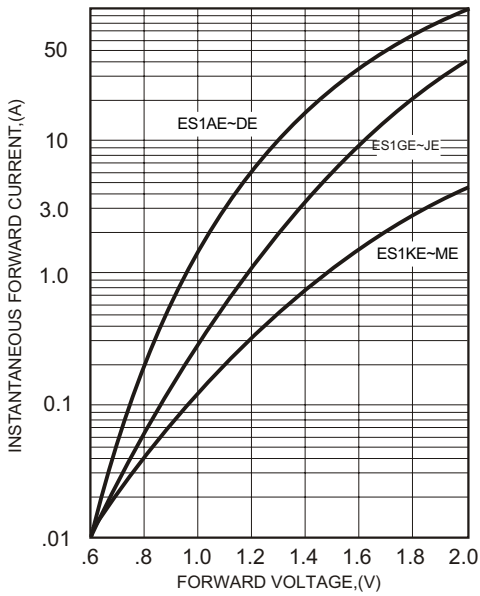

Instantaneous Forward Current - Amperes *versus*
Instantaneous Forward Voltage - Volts

Figure 2
Forward Derating Curve

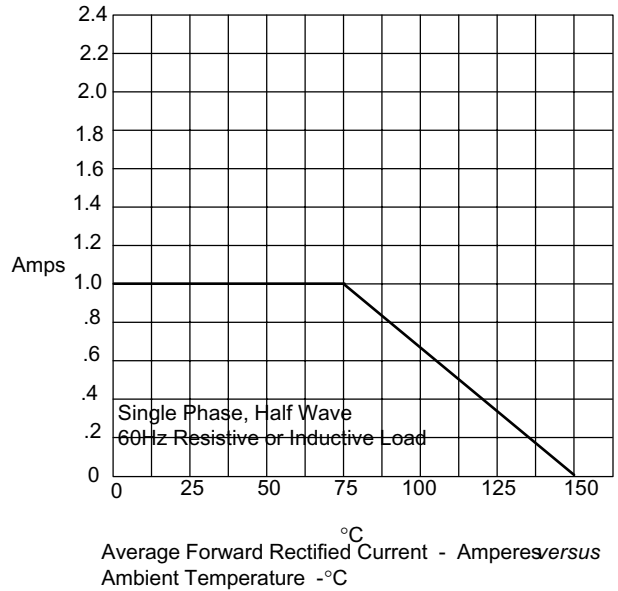

Single Phase, Half Wave
60Hz Resistive or Inductive Load
Average Forward Rectified Current - Amperes *versus*
Ambient Temperature - °C

Figure 3
Junction Capacitance

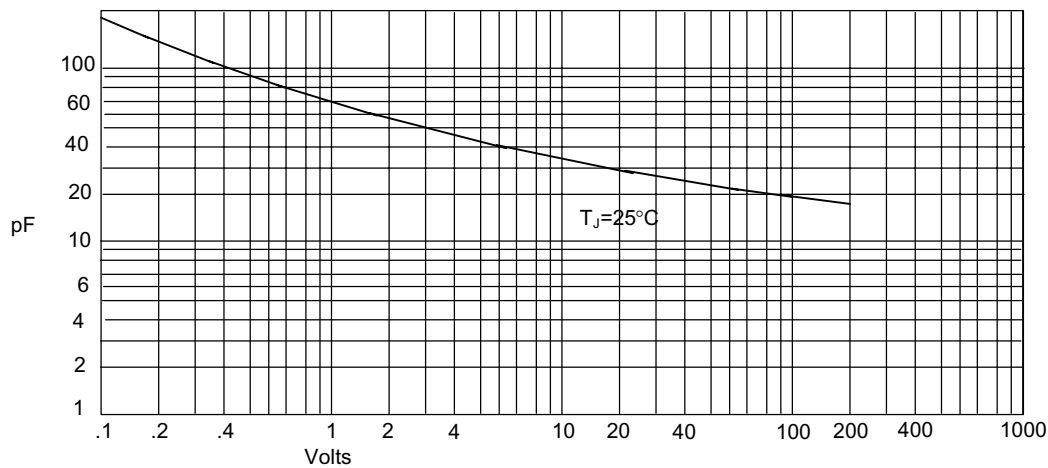

Junction Capacitance - pF *versus*
Reverse Voltage - Volts

ES1AE thru ES1ME

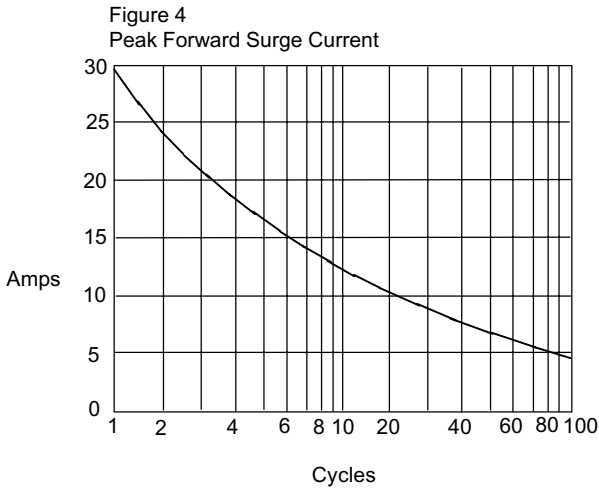

Peak Forward Surge Current - Amperes versus
 Number Of Cycles At 60Hz - Cycles

Figure 6
 Reverse Recovery Time Characteristic And Test Circuit Diagram

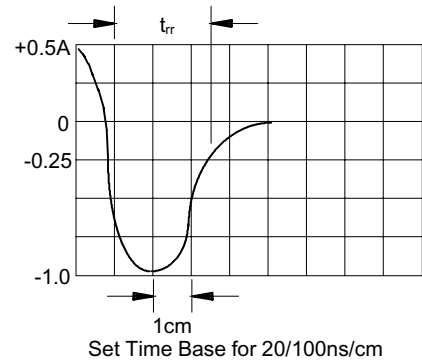
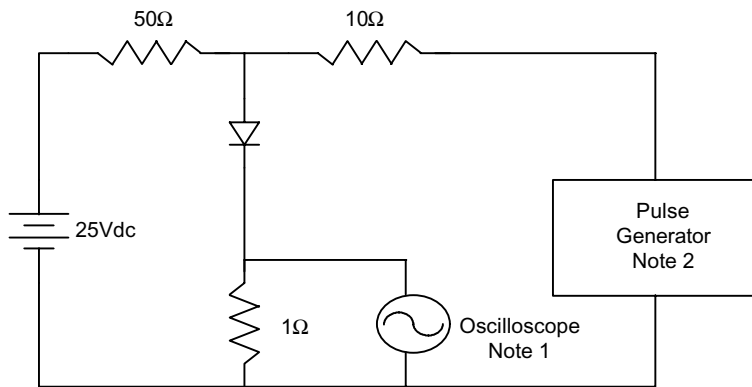

Notes:

1. Rise Time = 7ns max.
 Input impedance = 1 megohm, 22pF
2. Rise Time = 10ns max.
 Source impedance = 50 ohms
3. Resistors are non-inductive



Micro Commercial Components

Ordering Information :

| Device | Packing |
|----------------|-----------------------|
| Part Number-TP | Tape&Reel: 6Kpcs/Reel |

Note : Adding "-HF" suffix for halogen free, eg. Part Number-TP-HF

IMPORTANT NOTICE

Micro Commercial Components Corp. reserves the right to make changes without further notice to any product herein to make corrections, modifications , enhancements , improvements , or other changes . **Micro Commercial Components Corp .** does not assume any liability arising out of the application or use of any product described herein; neither does it convey any license under its patent rights ,nor the rights of others . The user of products in such applications shall assume all risks of such use and will agree to hold **Micro Commercial Components Corp .** and all the companies whose products are represented on our website, harmless against all damages.

LIFE SUPPORT

MCC's products are not authorized for use as critical components in life support devices or systems without the express written approval of Micro Commercial Components Corporation.

CUSTOMER AWARENESS

Counterfeiting of semiconductor parts is a growing problem in the industry. Micro Commercial Components (MCC) is taking strong measures to protect ourselves and our customers from the proliferation of counterfeit parts. MCC strongly encourages customers to purchase MCC parts either directly from MCC or from Authorized MCC Distributors who are listed by country on our web page cited below. Products customers buy either from MCC directly or from Authorized MCC Distributors are genuine parts, have full traceability, meet MCC's quality standards for handling and storage. **MCC will not provide any warranty coverage or other assistance for parts bought from Unauthorized Sources.** MCC is committed to combat this global problem and encourage our customers to do their part in stopping this practice by buying direct or from authorized distributors.

www.mccsemi.com