

CLF12577NIT-151M-D

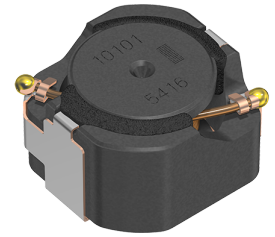

Applications	Automotive Grade
Feature	<div style="border: 1px solid black; padding: 2px; display: inline-block; margin-bottom: 2px;">AEC-Q200</div> AEC-Q200 <div style="border: 1px solid black; padding: 2px; display: inline-block; margin-bottom: 2px;">Wire Wound</div> Wire Wound <div style="border: 1px solid black; padding: 2px; display: inline-block; margin-bottom: 2px;">Shield</div> Magnetic Shield <div style="border: 1px solid black; padding: 2px; display: inline-block; margin-bottom: 2px;">Ferrite Core</div> Ferrite Core
Series	CLF-NI-D
Status	Production



Size	
Length(L)	12.80mm ±0.30mm
Width(W)	12.50mm ±0.30mm
Thickness(T)	7.70mm ±0.30mm
Recommended Land Pattern (A)	4.50mm Nom.
Recommended Land Pattern (B)	6.20mm Nom.
Recommended Land Pattern (C)	4.20mm Nom.

Electrical Characteristics	
Inductance	150μH ±20% at 100kHz
Rated Current (L Change) [Typ.]	2.4A (30% Down)
Rated Current (L Change) [Max.]	1.8A (30% Down)
Rated Current (Temperature Rise) [Typ.]	2.1A (40°C Rise)
Rated Current (Temperature Rise) [Max.]	
DC Resistance [Typ.]	170mΩ
DC Resistance [Max.]	204mΩ
Self Resonant Frequency [Min.]	
Self Resonant Frequency [Typ.]	
Q [Min.]	
Q [Typ.]	

Other	
Operating Temp. Range (Including Self-Temp. Rise)	-55 to 150°C
Soldering Method	Reflow Iron Soldering
AEC-Q200	Yes
Packing	Blister (Plastic)Taping [330mm Reel]
Package Quantity	500pcs
Weight	4g

! Images are for reference only and show exemplary products.
 ! This PDF document was created based on the data listed on the TDK Corporation website.
 ! All specifications are subject to change without notice.

CLF12577NIT-151M-D



Characteristic Graphs(This is reference data, and does not guarantee the products characteristics.)

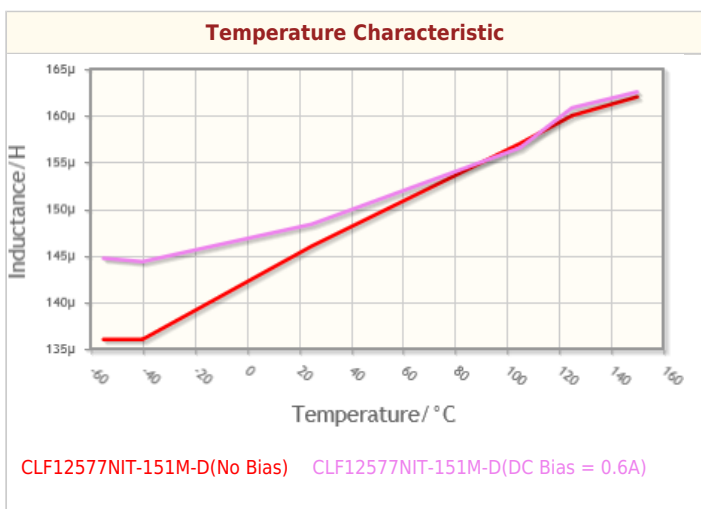
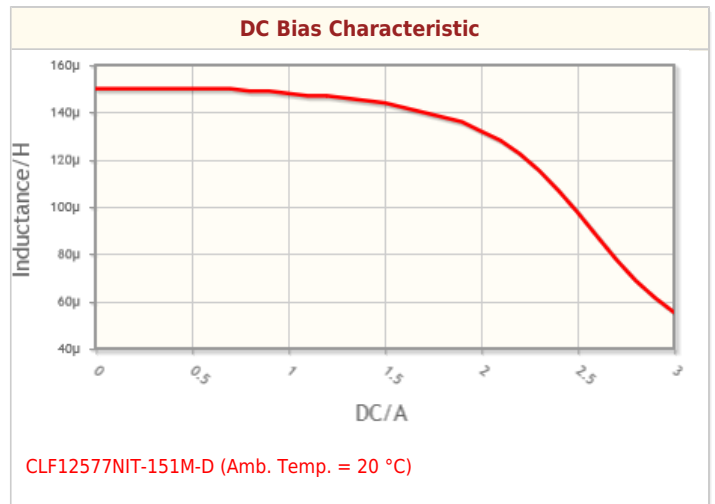
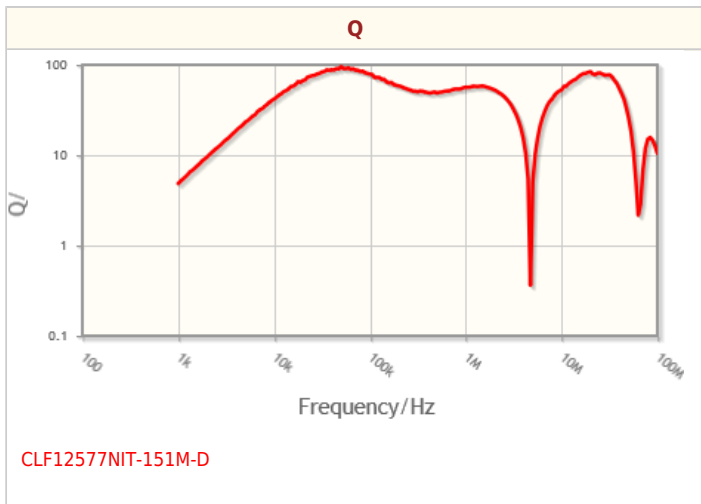
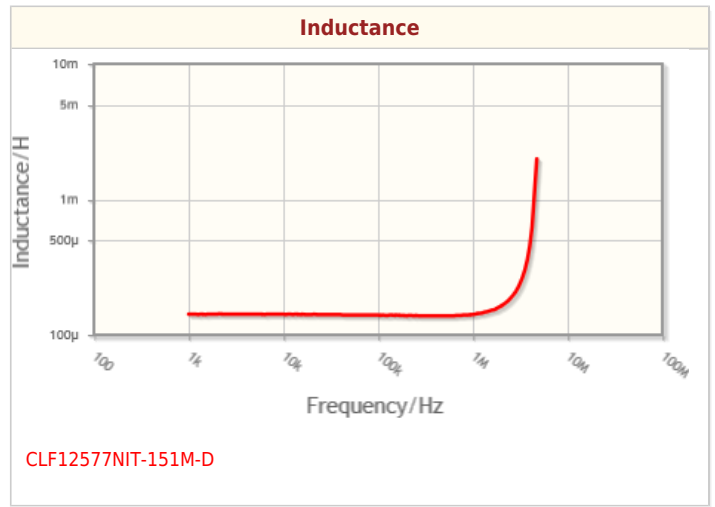
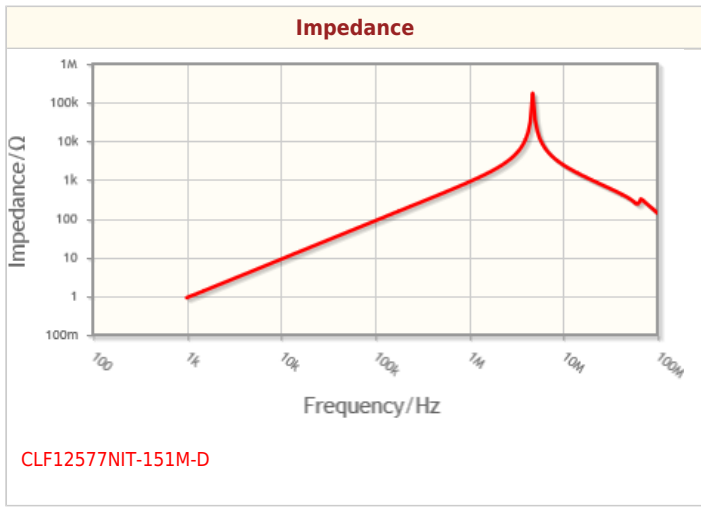

! Images are for reference only and show exemplary products.
! This PDF document was created based on the data listed on the TDK Corporation website.
! All specifications are subject to change without notice.

CLF12577NIT-151M-D



Associated Images

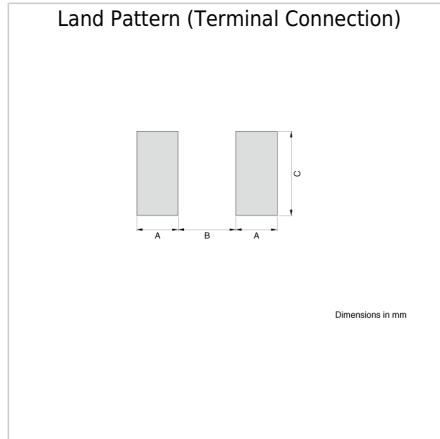
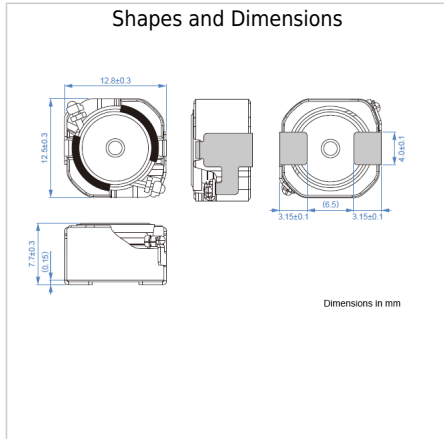

! Images are for reference only and show exemplary products.
! This PDF document was created based on the data listed on the TDK Corporation website.
! All specifications are subject to change without notice.