



# 2731-100M

100 Watts, 36 Volts, 200 $\mu$ s, 10%  
Radar 2700-3100 MHz

## GENERAL DESCRIPTION

The 2731-100M is an internally matched, COMMON BASE bipolar transistor capable of providing 100 Watts of pulsed RF output power at 200 $\mu$ s pulse width, 10% duty factor across the 2700 to 3100 MHz band. The transistor prematch and test fixture has been optimized through the use of 10 Ohm TRL Analysis. This ceramic sealed transistor is specifically designed for S-band radar applications. It utilizes gold metallization and emitter ballasting to provide high reliability and supreme ruggedness.

## CASE OUTLINE

**55KS-1**  
**Common Base**

## ABSOLUTE MAXIMUM RATINGS

### Maximum Power Dissipation

Device Dissipation @ 25°C<sup>1</sup> 575 W

### Maximum Voltage and Current

Collector to Base Voltage (BV<sub>ces</sub>) 65 V

Emitter to Base Voltage (BV<sub>ebo</sub>) 3.0 V

Collector Current (I<sub>c</sub>) 15.0 A

### Maximum Temperatures

Storage Temperature -65 to +200 °C

Operating Junction Temperature +200 °C

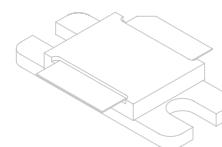

## ELECTRICAL CHARACTERISTICS @ 25°C

SYMBOL	CHARACTERISTICS	TEST CONDITIONS	MIN	TYP	MAX	UNITS
P <sub>out</sub>	Power Output	F=2700-3100 MHz	100	115	140	W
P <sub>g</sub>	Power Gain	Pulse Width = 200 $\mu$ s	8.0	8.5	9.4	dB
$\eta_c$	Collector Efficiency	Duty Factor = 10 %	40			%
R <sub>l</sub>	Return Loss	Power Input = 16W	-7			dB
P <sub>d</sub>	Pulse Droop	V <sub>cc</sub> = +36V			0.6	dB
VSWR-T	Load Mismatch Tolerance	F = 2700, 2900, 3100 MHz			2:1	

## FUNCTIONAL CHARACTERISTICS @ 25°C

BV <sub>ebo</sub>	Emitter to Base Breakdown	I <sub>e</sub> = 30 mA	3.0			V
BV <sub>ces</sub>	Collector to Emitter Breakdown	I <sub>c</sub> = 120 mA	65			V
h <sub>FE</sub>	DC – Current Gain	V <sub>ce</sub> = 5V, I <sub>c</sub> = 600 mA		15		
$\theta_{jc}$ <sup>1</sup>	Thermal Resistance				0.43	°C/W

Issue March 2006

Microsemi reserves the right to change, without notice, the specifications and information contained herein.  
Visit our web site at [www.microsemi.com](http://www.microsemi.com) or contact our factory direct.



2731-100M

Vcc = 36 Volts, Pulse Width = 200 $\mu$ s, Duty = 10 %

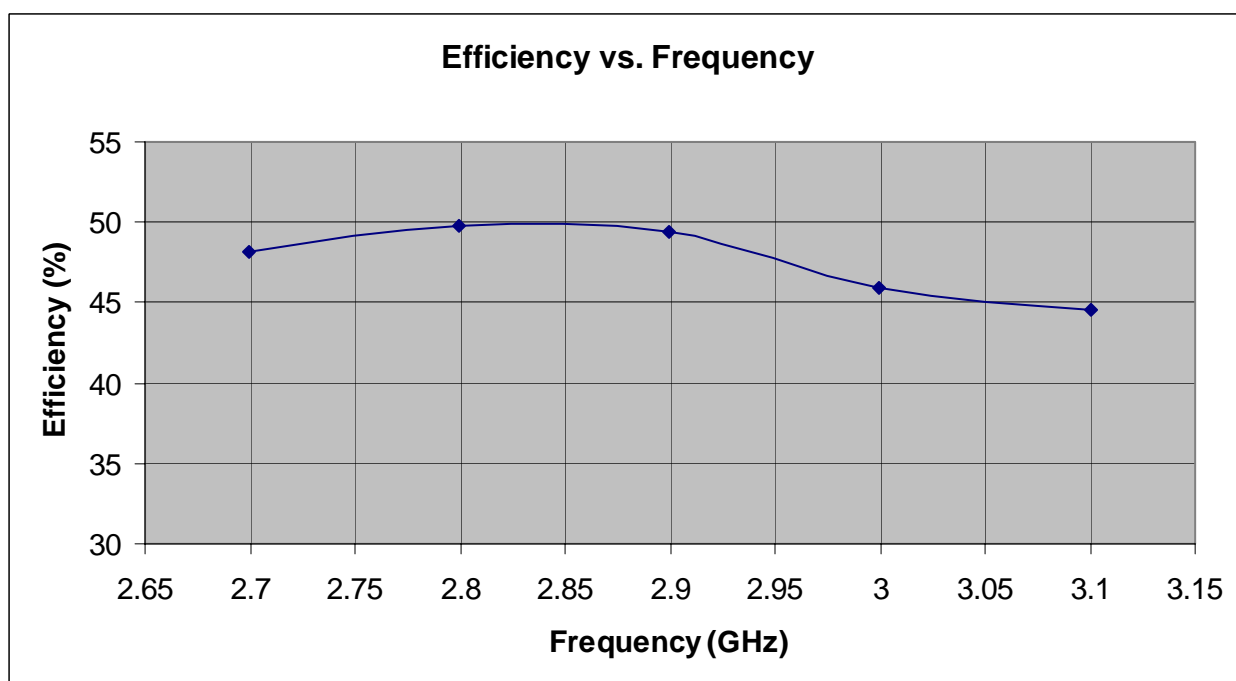
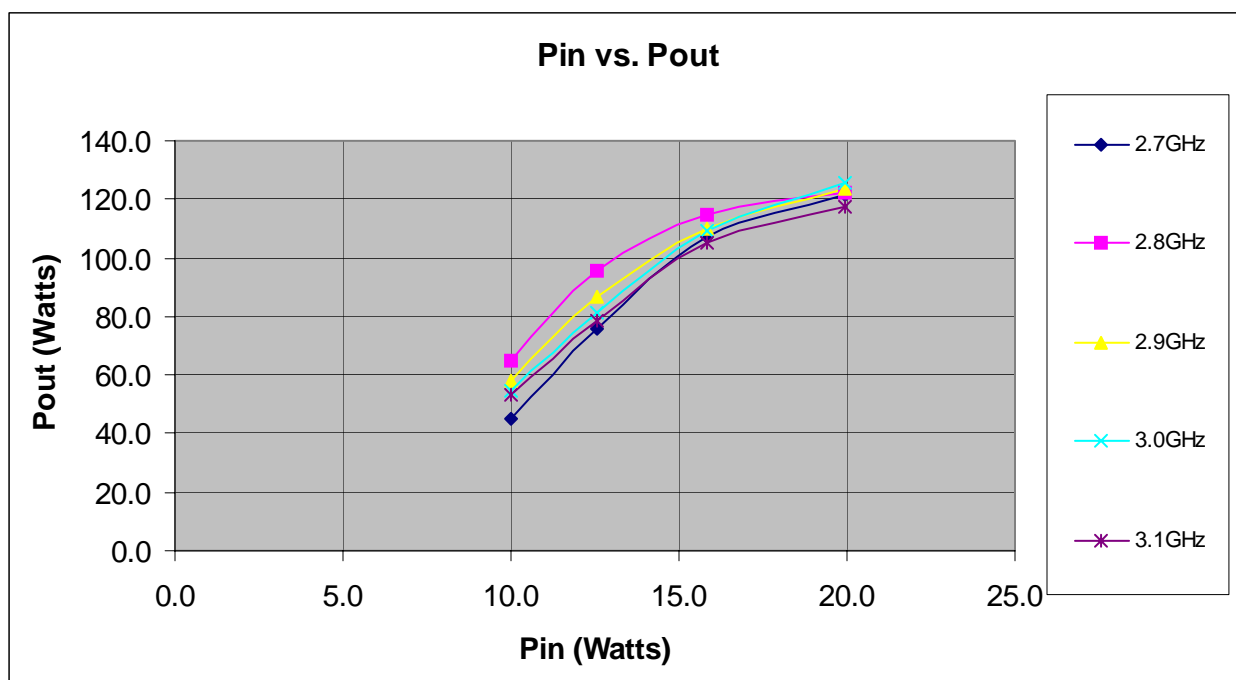

Microsemi reserves the right to change, without notice, the specifications and information contained herein.  
 Visit our web site at [www.microsemi.com](http://www.microsemi.com) or contact our factory direct.

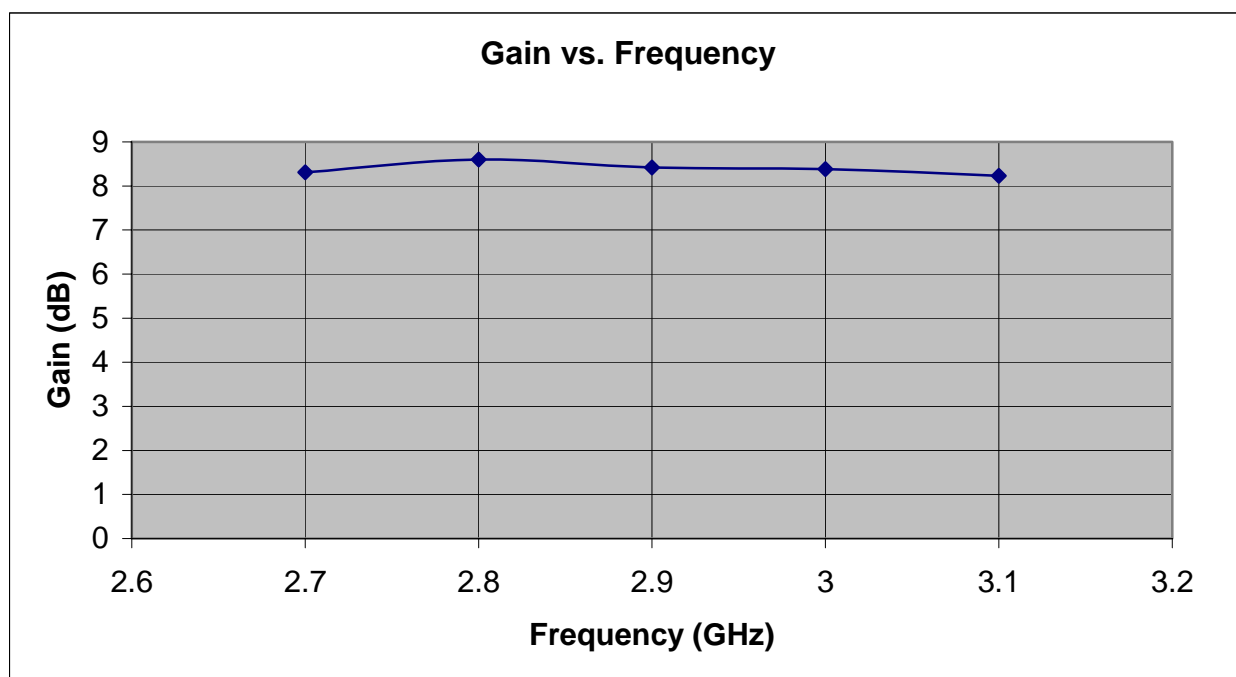

*Impedance curves will be added at the completion of the characterization.*

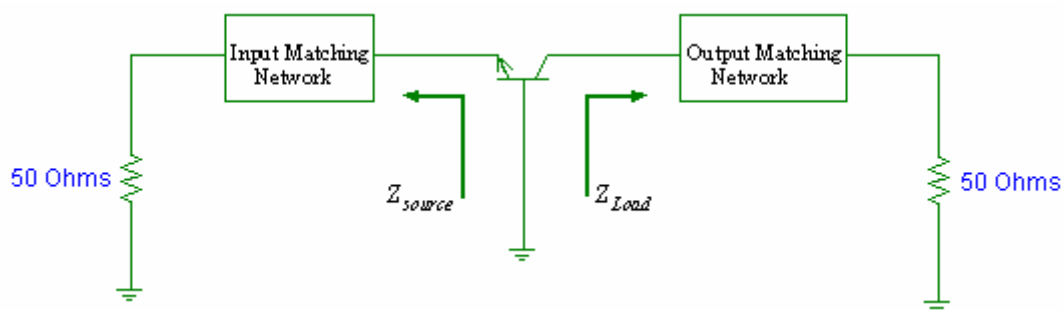

Impedance Data		
Freq (GHz)	Zs	Zl
2.7	8.87-j12.64	4.33-j4.67
2.8	8.24-j10.26	3.95-j4.94
2.9	8.54-j8.06	3.47-j5.08
3.0	9.85-j6.05	2.96-j5.06
3.1	10.26-j4.88	2.48-j4.92

Microsemi reserves the right to change, without notice, the specifications and information contained herein.  
 Visit our web site at [www.microsemi.com](http://www.microsemi.com) or contact our factory direct.

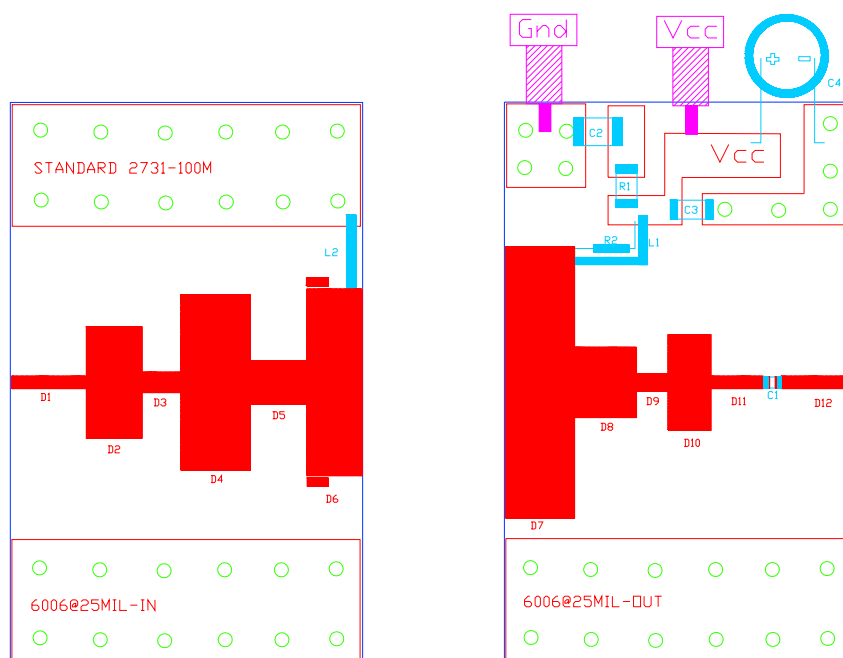

Circuit Component		
Item	Description	Value
C1	Chip Cap A size	9.1pF
C2	Chip Cap B size	10,000pF
C3	Chip Cap B size	100pF
C4	Electrolytic Cap	2200uF
R1	Chip resistor	20 ohms
R2	Fix resistor	1.5 ohms
L1	Silver ribbon	L=870 Mil, W=70 Mil.
L2	Copper wire	21 AWG, 560 Mil
Material	Roger-Duroid	6006 @ 25Mil, Er=6.15, 1Oz Cu

Physical Circuit Dimension		
Item	W (Mil)	L (Mil)
D1	35	210
D2	318	158
D3	58	114
D4	500	195
D5	124	161
D6	530	156
D7	770	196
D8	200	176
D9	48	92
D10	272	119
D11	35	150
D12	35	200

Microsemi reserves the right to change, without notice, the specifications and information contained herein.  
 Visit our web site at [www.microsemi.com](http://www.microsemi.com) or contact our factory direct.

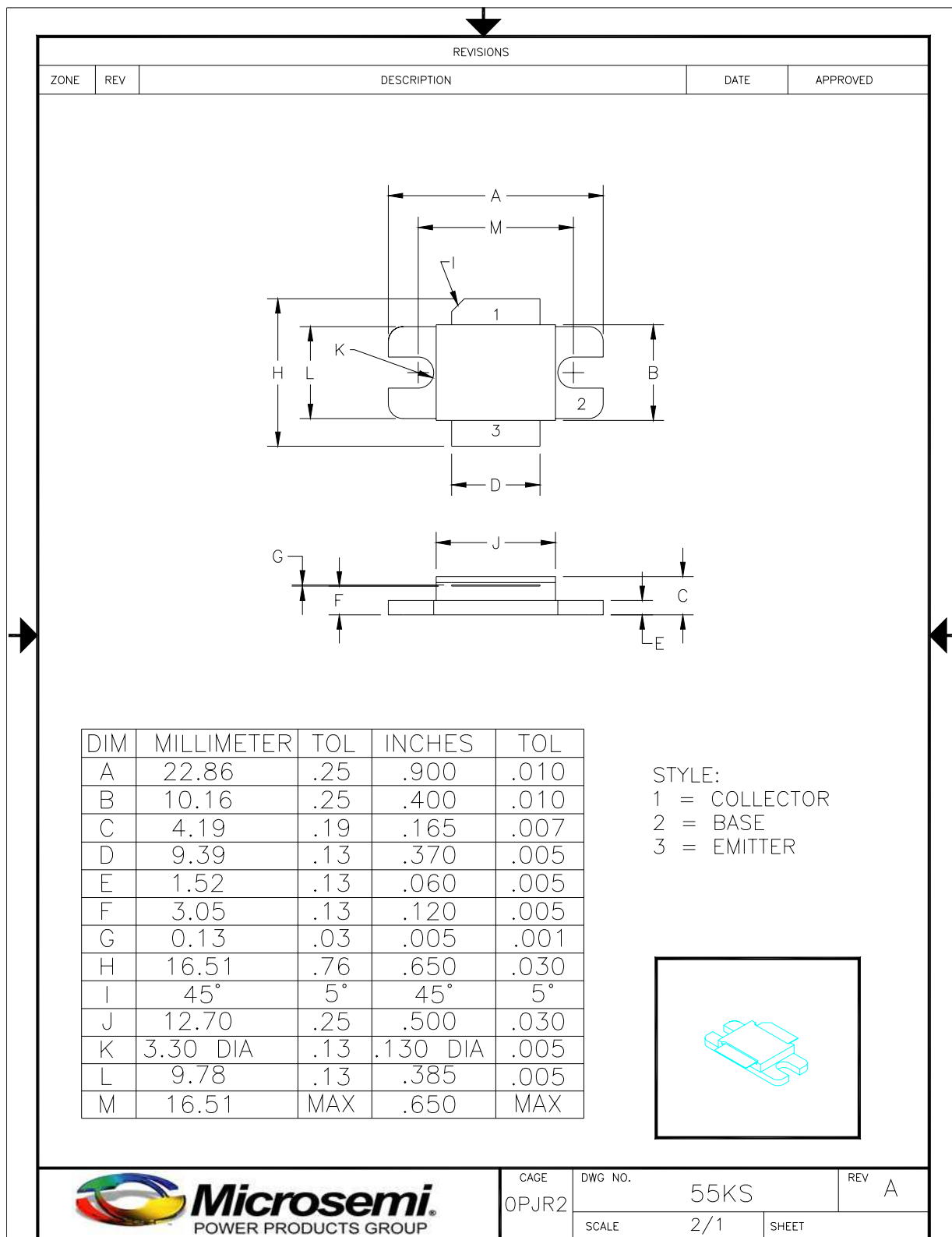
**2731-100M**

Microsemi reserves the right to change, without notice, the specifications and information contained herein.  
 Visit our web site at [www.microsemi.com](http://www.microsemi.com) or contact our factory direct.