

QUADRUPLE RS-423-B DRIVER/RECEIVER

FEATURES

- Four Independent Drivers and Receivers
- Driver Slew Rate Controlled by a Single Resistor
- Fast Driver Transition Times Down to 1.5 μ s and Receiver Transition Times of 20 ns Typ
- Internal Thermal-Overload Protection
- RS-423-B Inputs and Outputs Designed to Withstand ± 25 V
- ESD Protection Exceeds 2000 V Per MIL-STD-883C Method 3015
- LinBICMOS™ Process Technology

DESCRIPTION

The SN75LBC784 performs as four independent RS-423-B driver/receiver pairs designed to interface data terminal equipment (DTE) with data circuit-terminating equipment (DCE) at rates up to 120 kbps and distances to 1.2 km. The SN75LBC784 provides an upgrade to the RS-232 serial interface and can be backwards-compatible with existing serial ports while offering the higher performance required by new faster peripherals, such as v.34 (v.fast) modems. The RS-232 standard, and subsequent revisions, only supports data rates up to 20 kbps over about 15 meters of cable. For RS-423-B the data rate is increased to 120 kbps and transmission distance to 1.2 km by reducing the maximum output signal swing, increasing the driver output current, and reducing the receiver input voltage thresholds.

The receivers consist of differential comparators with hysteresis and resistive attenuation on the inputs. The resistive attenuation improves the input common-mode range and also provides additional protection from ESD and over-voltage stress. The differential and common-mode input impedances are sufficiently high to meet RS-423-B. When a differential voltage input of 500 mV is applied across the entire common-mode range (see Figure 5), the receiver characteristics and bias voltage allow the receiver to remain in its intended binary state.

The drivers meet all RS-423-B specifications with built-in current limits and thermal overload protection. Slew-rate controlling circuitry is included in the design, which is adjusted to suit the application by means of an external resistor (R_{WS}). The slew rate controlling circuitry also has a default mode—if the R_{WS} pin is shorted to 5 V externally, the transition time defaults to approximately 1.5 ms. The BIAS input, when shorted to 5 V externally, provides the internal node voltages. The receiver is compatible to RS-232 with the use of external input resistors to meet the RS-232 input resistance specification of 3 k Ω to 7 k Ω .

The SN75LBC784 is characterized for operation over the temperature range of 0°C to +70°C.



Please be aware that an important notice concerning availability, standard warranty, and use in critical applications of Texas Instruments semiconductor products and disclaimers thereto appears at the end of this data sheet.

LinBICMOS is a trademark of Texas Instruments Incorporated. All other trademarks are the property of their respective owners.

PRODUCTION DATA information is current as of publication date. Products conform to specifications per the terms of Texas Instruments standard warranty. Production processing does not necessarily include testing of all parameters.

DW PACKAGE
(TOP VIEW)

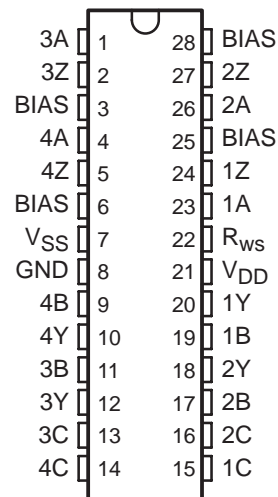

FUNCTION TABLE

INPUTS			OUTPUTS	
A	B	C	Z	Y
L	L	H	H	H
H	L	H	H	L
L	H	L	L	H
H	H	L	L	L
L	L	L	?	H
H	L	L	?	L
L	H	H	?	H
H	H	H	?	L

H = high level, L = low level,
X = irrelevant, Z = high impedance (off)
? = indeterminate

logic diagram (positive logic)

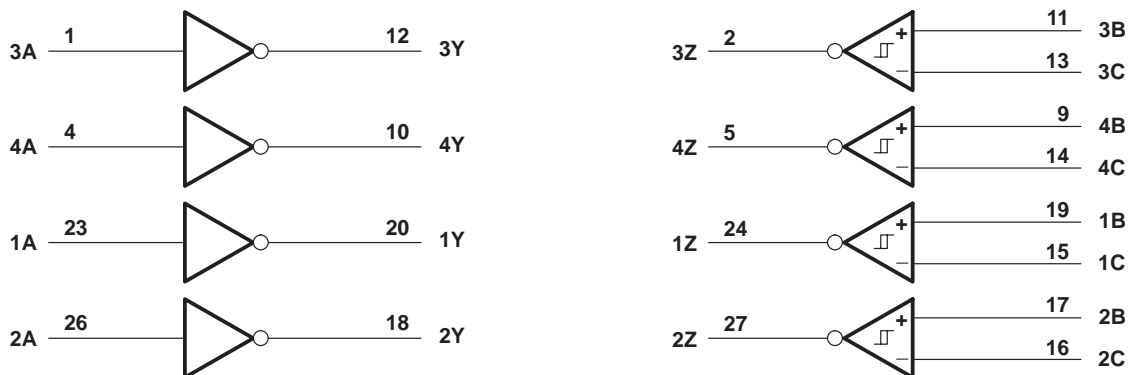

absolute maximum ratings over operating free-air temperature range (unless otherwise noted)†

Positive supply voltage, $V_{DD}^{(1)}$	14 V
Negative supply voltage, V_{SS}	-14 V
Bias voltage, V_{bias}	5.75 V
Receiver input voltage range	-30 V to 30 V
Driver input voltage range	-0.5 V to 5.75 V
Driver output voltage range (supplies at 0 V)	-30 V to 30 V
Driver output voltage range (supplies at ± 12 V)	-25 V to 25 V
Continuous power dissipation	See Dissipation Rating Table
Operating free-air temperature range, T_A	0°C to +70°C
Storage temperature range	-65°C to +150°C
Case temperature for 10 seconds	+260°C

† Stresses beyond those listed under absolute maximum ratings may cause permanent damage to the device. These are stress ratings only, and functional operation of the device at these or any other conditions beyond those indicated under recommended operating conditions is not implied. Exposure to absolute-maximum-rated conditions for extended periods may affect device reliability.

(1) All voltages are with respect to network ground terminal.

DISSIPATION RATING TABLE

PACKAGE	$T_A \leq +25^\circ\text{C}$ POWER RATING	DERATING FACTOR† ABOVE $T_A = +25^\circ\text{C}$	$T_A = +70^\circ\text{C}$ POWER RATING
DW	1348 mW	10.8 mW/°C	862 mW

† Derating factors are the inverse of the junction-to-ambient thermal resistance when board-mounted with no air flow.

recommended operating conditions

	MIN	NOM	MAX	UNIT
Supply voltage, V_{DD}	10.8	12	13.2	V
Supply voltage, V_{SS}	-10.8	-12	-13.2	V
Bias voltage, V_{bias}	2	5	5.5	V
High-level input voltage, V_{IH}	Driver		2	V
Low-level input voltage, V_{IL}	Driver		0.8	V
High-level output current, I_{OH}	Receiver		-4	mA
Low-level output current, I_{OL}	Receiver		4	mA
Rws slew rate control resistor	20	82	820	k Ω
Operating free-air temperature, T_A	0		+70	°C

DRIVER SECTION

electrical characteristics over recommended ranges of supply voltage and operating free-air temperature, $V_{DD} = 10.8\text{ V}$ to 13.2 V , $V_{SS} = -10.8\text{ V}$ to -13.2 V , $T_A = 0^\circ\text{C}$ to $+70^\circ\text{C}$ (unless otherwise noted).

PARAMETER		TEST CONDITIONS	MIN	TYP	MAX	UNIT
V_{OH}	High-level output voltage	Open circuit or $R_L = 450\ \Omega$	4	5.5	6	V
V_{OL}	Low-level output voltage	Open circuit or $R_L = 450\ \Omega$	-6	-5.5	-4	V
I_{IH}	High-level input current	$V_I = 2.4\text{ V}$ to 5.5 V			100	μA
I_{IL}	Low-level input current	$V_I = 0\text{ V}$ to 0.8 V	-100			μA
I_O	Output leakage current	$V_{DD} = V_{SS} = 0$, $V_O = \pm 6\text{ V}$	-100		100	μA
$I_{OS(H)}$	High-level short circuit output current	$V_I = 5\text{ V}$, $V_O = 0$	15		45	mA
$I_{OS(L)}$	Low-level short circuit output current	$V_I = 0$, $V_O = 0$	-45		-15	mA
I_{DD}	Supply current	No load		10	12	mA
		$R_L = 450\ \Omega$		60	70	
I_{SS}	Supply current	No load		-10	-12	mA
		$R_L = 450\ \Omega$		-60	-70	
I_{bias}	Bias current				400	μA

switching characteristics over recommended ranges of supply voltage and operating free-air temperature, $V_{DD} = 10.8\text{ V}$ to 13.2 V , $V_{SS} = -10.8\text{ V}$ to -13.2 V , $T_A = 0^\circ\text{C}$ to $+70^\circ\text{C}$ (unless otherwise noted).

PARAMETER		TEST CONDITIONS		MIN	TYP	MAX	UNIT	
t_{TLH}	Transition time, low-to-high level (see Figure 1)	$R_L = 450\ \Omega$, $V_{WS} = 5\text{ V}$	$C_L = 50\text{ pF}$,	$R_{WS} = 0\text{ k}\Omega$		1.5	μs	
				$R_{WS} = 20\text{ k}\Omega$	1.5	2.1		2.7
				$R_{WS} = 82\text{ k}\Omega$	5	8		11
				$R_{WS} = 820\text{ k}\Omega$		80		
t_{THL}	Transition time, high-to-low level (see Figure 1)	$R_L = 450\ \Omega$, $V_{WS} = 5\text{ V}$	$C_L = 50\text{ pF}$,	$R_{WS} = 0\text{ k}\Omega$		1.5	μs	
				$R_{WS} = 20\text{ k}\Omega$	1.5	2.1		2.7
				$R_{WS} = 82\text{ k}\Omega$	5	8		11
				$R_{WS} = 820\text{ k}\Omega$		80		
SR	Output slew rate			$R_{WS} = 20\text{ k}\Omega$		15	V/ μs	
t_{sk}	Output skew (see Figure 4) $ t_{PHL} - t_{PLH} $			$R_{WS} = 82\text{ k}\Omega$		1	μs	

RECEIVER SECTION

electrical characteristics over recommended ranges of supply voltage and operating free-air temperature, $V_{DD} = 10.8\text{ V to }13.2\text{ V}$, $V_{SS} = -10.8\text{ V to }-13.2\text{ V}$, $T_A = 0^\circ\text{C to }+70^\circ\text{C}$ (unless otherwise noted)

PARAMETER		TEST CONDITIONS	MIN	TYP	MAX	UNIT	
V_{IT+}	Positive input threshold voltage				200	mV	
		With 500 Ω series resistor			400		
V_{IT-}	Negative input threshold voltage				-200	mV	
		With 500 Ω series resistor			-400		
I_I	Input current	$V_I = 10\text{ V}$	Other input to GND		1.3	3.25	mA
		$V_I = -10\text{ V}$			-3.25	-1.3	
V_{hys}	Hysteresis ($V_{IT+} - V_{IT-}$)		20	40	150	mV	
V_{OH}	High-level output voltage (1)	$I_O = -20\ \mu\text{A}$		3.5	5	V	
		$I_O = -4\text{ mA}$		2.4	5		
V_{OL}	Low-level output voltage	$I_O = 20\ \mu\text{A to }4\text{ mA}$			0.4	V	
I_{RX}	RX short circuit current				50	mA	
V_{ID}	Differential input voltage	Receiver inputs open circuit	1.6	2.1	2.6	V	
V_{ofs}	Fail safe output voltage	See Note 2	3.5			V	

(1) Device has an internal RX supply regulator. Maximum RX logic output voltage under no load is thus defined by an internal voltage value. This is nominally set to 4.5 V with a tolerance of $\pm 5\%$.

(2) One input at ground, other input open circuit, $I_O = -20\ \mu\text{A}$, or both open circuit.

switching characteristics over recommended ranges of supply voltage and operating free-air temperature (unless otherwise noted)

test conditions: $V_{DD} = 10.8\text{ V to }13.2\text{ V}$, $V_{SS} = -10.8\text{ V to }-13.2\text{ V}$, $T_A = 0^\circ\text{C to }+70^\circ\text{C}$ (unless otherwise noted)

PARAMETER		TEST CONDITIONS	MIN	NOM	MAX	UNIT
t_{PLH}	Propagation delay time low-to-high (see Figure 2)	$C_L = 50\text{ pF}$		0.15	1	μs
t_{PHL}	Propagation delay time high-to-low (see Figure 2)					
t_{THL}	Transition time high-to-low (see Figure 3)			20	200	ns
t_{TLH}	Transition time low-to-high (see Figure 3)					

PARAMETER MEASUREMENT INFORMATION

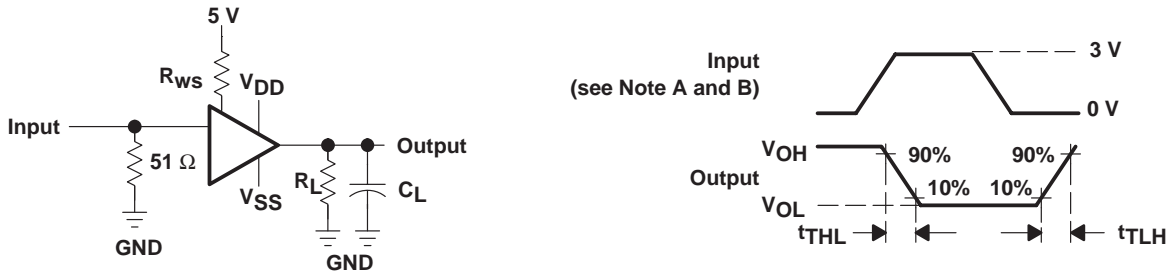

Figure 1. Driver Transition Times

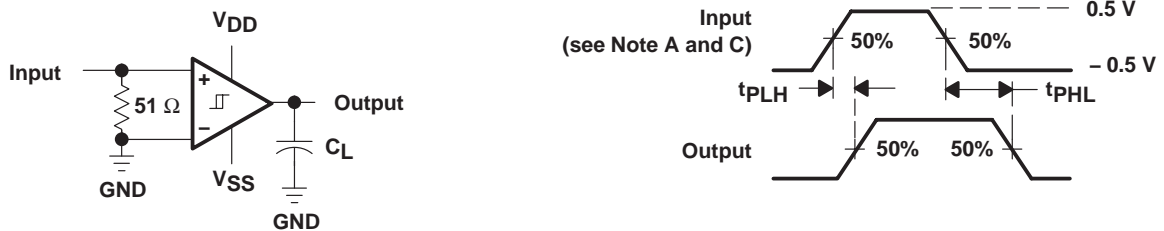

Figure 2. Receiver Propagation Delay Times

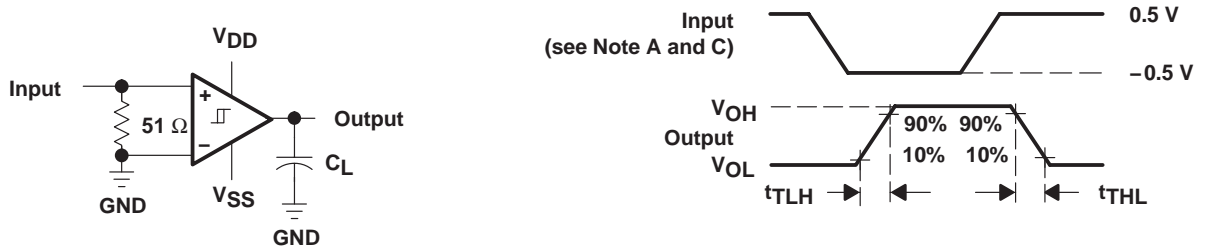

Figure 3. Receiver Transition Times

NOTES:A. C_L includes probe and jig capacitance.

B. The input pulse is supplied by a generator having the following characteristics: $t_r \leq 10$ nS, $t_f < 10$ nS, $Z_0 = 50 \Omega$, PRR ≥ 5 kHz, duty cycle 50%, $V_{max} = 3$ V, $V_{min} = 0$ V.

C. The input pulse is supplied by a generator having the following characteristics: $t_r \leq 10$ nS, $t_f < 10$ nS, $Z_0 = 50 \Omega$, PRR ≥ 5 kHz, duty cycle 50%, $V_{max} = 0.5$ V, $V_{min} = -0.5$ V.

PARAMETER MEASUREMENT INFORMATION, CONTINUED

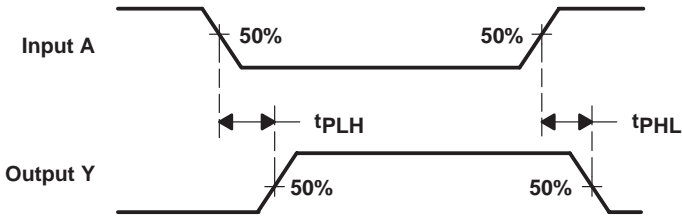

Figure 4. Skew Definition Times

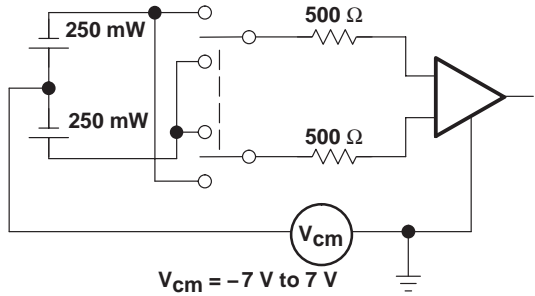

Figure 5. Receiver Input Balance Test

Revision History

DATE	REV	PAGE	SECTION	DESCRIPTION
6/07	B	Front Page	—	Updated front page.
		2	—	Corrected pin references in positive logic diagram (receiver 1, receiver 2).

NOTE: Page numbers for previous revisions may differ from page numbers in the current version.

PACKAGING INFORMATION

Orderable Device	Status ⁽¹⁾	Package Type	Package Drawing	Pins	Package Qty	Eco Plan ⁽²⁾	Lead/Ball Finish	MSL Peak Temp ⁽³⁾
SN75LBC784DW	OBSOLETE	SOIC	DW	28		TBD	Call TI	Call TI
SN75LBC784DWG4	OBSOLETE	SOIC	DW	28		TBD	Call TI	Call TI
SN75LBC784DWR	OBSOLETE	SOIC	DW	28		TBD	Call TI	Call TI
SN75LBC784DWRG4	OBSOLETE	SOIC	DW	28		TBD	Call TI	Call TI

⁽¹⁾ The marketing status values are defined as follows:

ACTIVE: Product device recommended for new designs.

LIFEBUY: TI has announced that the device will be discontinued, and a lifetime-buy period is in effect.

NRND: Not recommended for new designs. Device is in production to support existing customers, but TI does not recommend using this part in a new design.

PREVIEW: Device has been announced but is not in production. Samples may or may not be available.

OBSOLETE: TI has discontinued the production of the device.

⁽²⁾ Eco Plan - The planned eco-friendly classification: Pb-Free (RoHS), Pb-Free (RoHS Exempt), or Green (RoHS & no Sb/Br) - please check <http://www.ti.com/productcontent> for the latest availability information and additional product content details.

TBD: The Pb-Free/Green conversion plan has not been defined.

Pb-Free (RoHS): TI's terms "Lead-Free" or "Pb-Free" mean semiconductor products that are compatible with the current RoHS requirements for all 6 substances, including the requirement that lead not exceed 0.1% by weight in homogeneous materials. Where designed to be soldered at high temperatures, TI Pb-Free products are suitable for use in specified lead-free processes.

Pb-Free (RoHS Exempt): This component has a RoHS exemption for either 1) lead-based flip-chip solder bumps used between the die and package, or 2) lead-based die adhesive used between the die and leadframe. The component is otherwise considered Pb-Free (RoHS compatible) as defined above.

Green (RoHS & no Sb/Br): TI defines "Green" to mean Pb-Free (RoHS compatible), and free of Bromine (Br) and Antimony (Sb) based flame retardants (Br or Sb do not exceed 0.1% by weight in homogeneous material)

⁽³⁾ MSL, Peak Temp. -- The Moisture Sensitivity Level rating according to the JEDEC industry standard classifications, and peak solder temperature.

Important Information and Disclaimer:The information provided on this page represents TI's knowledge and belief as of the date that it is provided. TI bases its knowledge and belief on information provided by third parties, and makes no representation or warranty as to the accuracy of such information. Efforts are underway to better integrate information from third parties. TI has taken and continues to take reasonable steps to provide representative and accurate information but may not have conducted destructive testing or chemical analysis on incoming materials and chemicals. TI and TI suppliers consider certain information to be proprietary, and thus CAS numbers and other limited information may not be available for release.

In no event shall TI's liability arising out of such information exceed the total purchase price of the TI part(s) at issue in this document sold by TI to Customer on an annual basis.

DW (R-PDSO-G28)

PLASTIC SMALL OUTLINE

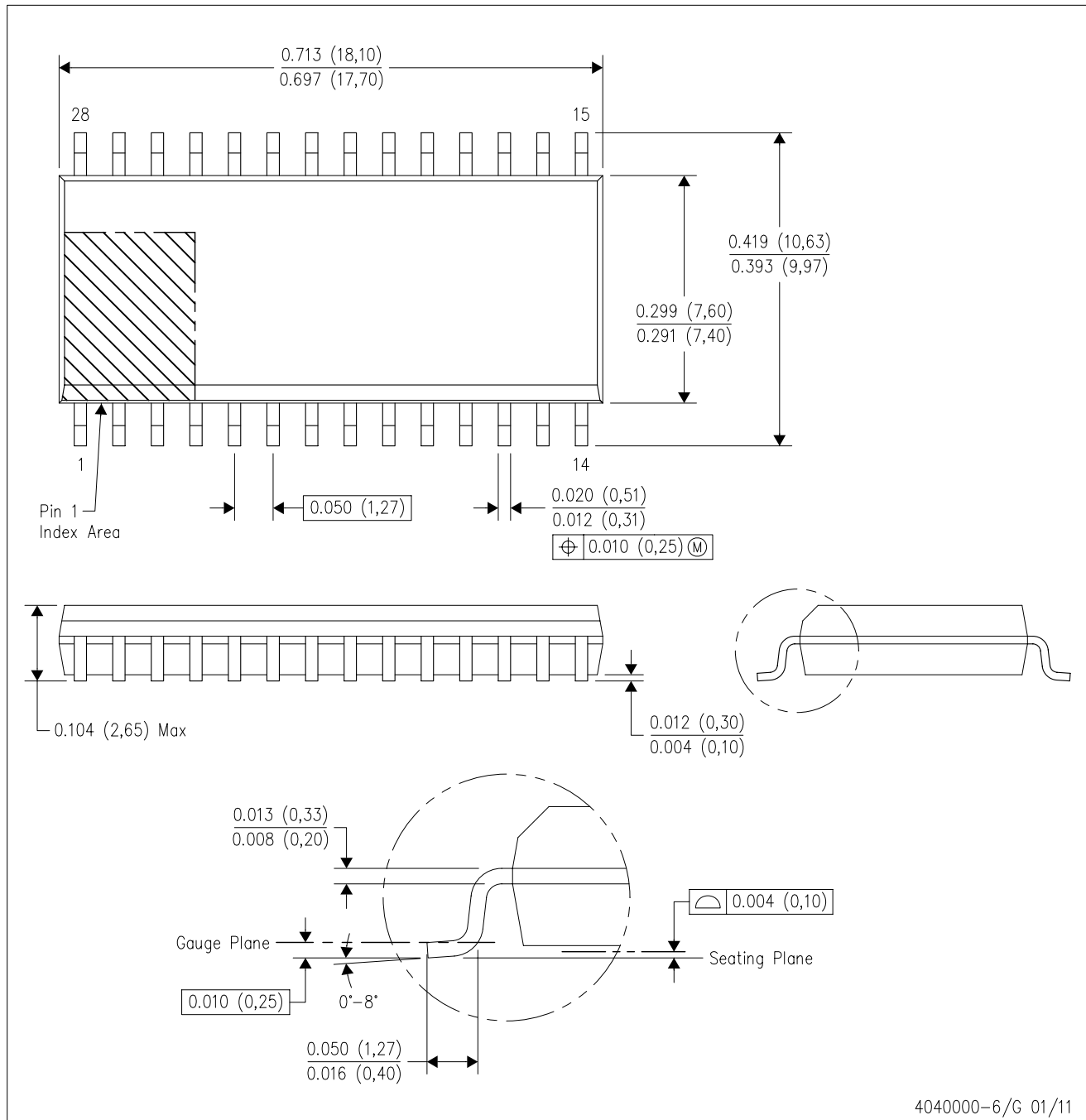

- NOTES:
- All linear dimensions are in inches (millimeters). Dimensioning and tolerancing per ASME Y14.5M-1994.
 - This drawing is subject to change without notice.
 - Body dimensions do not include mold flash or protrusion not to exceed 0.006 (0,15).
 - Falls within JEDEC MS-013 variation AE.

IMPORTANT NOTICE

Texas Instruments Incorporated and its subsidiaries (TI) reserve the right to make corrections, modifications, enhancements, improvements, and other changes to its products and services at any time and to discontinue any product or service without notice. Customers should obtain the latest relevant information before placing orders and should verify that such information is current and complete. All products are sold subject to TI's terms and conditions of sale supplied at the time of order acknowledgment.

TI warrants performance of its hardware products to the specifications applicable at the time of sale in accordance with TI's standard warranty. Testing and other quality control techniques are used to the extent TI deems necessary to support this warranty. Except where mandated by government requirements, testing of all parameters of each product is not necessarily performed.

TI assumes no liability for applications assistance or customer product design. Customers are responsible for their products and applications using TI components. To minimize the risks associated with customer products and applications, customers should provide adequate design and operating safeguards.

TI does not warrant or represent that any license, either express or implied, is granted under any TI patent right, copyright, mask work right, or other TI intellectual property right relating to any combination, machine, or process in which TI products or services are used. Information published by TI regarding third-party products or services does not constitute a license from TI to use such products or services or a warranty or endorsement thereof. Use of such information may require a license from a third party under the patents or other intellectual property of the third party, or a license from TI under the patents or other intellectual property of TI.

Reproduction of TI information in TI data books or data sheets is permissible only if reproduction is without alteration and is accompanied by all associated warranties, conditions, limitations, and notices. Reproduction of this information with alteration is an unfair and deceptive business practice. TI is not responsible or liable for such altered documentation. Information of third parties may be subject to additional restrictions.

Resale of TI products or services with statements different from or beyond the parameters stated by TI for that product or service voids all express and any implied warranties for the associated TI product or service and is an unfair and deceptive business practice. TI is not responsible or liable for any such statements.

TI products are not authorized for use in safety-critical applications (such as life support) where a failure of the TI product would reasonably be expected to cause severe personal injury or death, unless officers of the parties have executed an agreement specifically governing such use. Buyers represent that they have all necessary expertise in the safety and regulatory ramifications of their applications, and acknowledge and agree that they are solely responsible for all legal, regulatory and safety-related requirements concerning their products and any use of TI products in such safety-critical applications, notwithstanding any applications-related information or support that may be provided by TI. Further, Buyers must fully indemnify TI and its representatives against any damages arising out of the use of TI products in such safety-critical applications.

TI products are neither designed nor intended for use in military/aerospace applications or environments unless the TI products are specifically designated by TI as military-grade or "enhanced plastic." Only products designated by TI as military-grade meet military specifications. Buyers acknowledge and agree that any such use of TI products which TI has not designated as military-grade is solely at the Buyer's risk, and that they are solely responsible for compliance with all legal and regulatory requirements in connection with such use.

TI products are neither designed nor intended for use in automotive applications or environments unless the specific TI products are designated by TI as compliant with ISO/TS 16949 requirements. Buyers acknowledge and agree that, if they use any non-designated products in automotive applications, TI will not be responsible for any failure to meet such requirements.

Following are URLs where you can obtain information on other Texas Instruments products and application solutions:

Products

Audio	www.ti.com/audio
Amplifiers	amplifier.ti.com
Data Converters	dataconverter.ti.com
DLP® Products	www.dlp.com
DSP	dsp.ti.com
Clocks and Timers	www.ti.com/clocks
Interface	interface.ti.com
Logic	logic.ti.com
Power Mgmt	power.ti.com
Microcontrollers	microcontroller.ti.com
RFID	www.ti-rfid.com
RF/IF and ZigBee® Solutions	www.ti.com/lprf

Applications

Communications and Telecom	www.ti.com/communications
Computers and Peripherals	www.ti.com/computers
Consumer Electronics	www.ti.com/consumer-apps
Energy and Lighting	www.ti.com/energy
Industrial	www.ti.com/industrial
Medical	www.ti.com/medical
Security	www.ti.com/security
Space, Avionics and Defense	www.ti.com/space-avionics-defense
Transportation and Automotive	www.ti.com/automotive
Video and Imaging	www.ti.com/video
Wireless	www.ti.com/wireless-apps

TI E2E Community Home Page

e2e.ti.com

Mailing Address: Texas Instruments, Post Office Box 655303, Dallas, Texas 75265
Copyright © 2011, Texas Instruments Incorporated