

KEMET, SN, AC Line Filters, Normal Mode, 25 uH, MIN

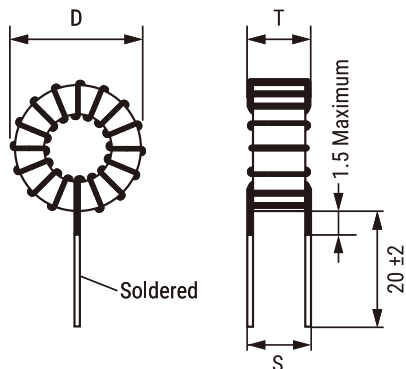

Dimensions	
D	13mm MAX
T	7mm MAX
LL	20mm +/-2mm
S	6mm NOM

Packaging Specifications	
Packaging:	Bulk
Packaging Quantity:	4800
Weight:	2.6 g

General Information	
Series:	SN
Style:	Through-Hole
Features:	Compact Size
RoHS:	Yes
Miscellaneous:	18 (K) Temperature Rise Max.

Specifications	
Inductance:	25 uH (0.1 MHz)
Inductance Tolerance:	MIN
Temperature Range:	-25/+105C
DC Resistance:	42 mOhms