

PPM50-G-xxELF PPM60-G-xxELF



PPM-SERIES

Rev.03-2013

- ✓ **50-60 Watt**
- ✓ Univ. **90-264VAC** (122-370VDC)
- ✓ **Single Output**
- ✓ **Over Voltage Protection** (out)
- ✓ **4 kV AC I/O Isolation**
- ✓ Low Ripple and Noise
- ✓ **High Efficiency**

The PPM-Series are high efficiency green power moduls with various packaging provided by Peak. The features of this series are: wide input voltage, DC and AC all in one, high efficiency, high reliability, low loss, safety isolation etc. They are widely used in industrial, office and civil equipments.

All specifications typical at Ta=25°C, nominal input voltage and full load unless otherwise specified

Input Specifications

Input Voltage Range	90 – 264 VAC or 122 – 370 VDC universal	
Input Under Voltage Protection	Start-up Voltage: 65-90 Vac (92-122VDC) Shutdown Voltage: 55- 75 Vac (79-105 VDC)	
Input Frequency	47 – 63 Hz	
Input Current	115 VAC at 1.4A, typ	230 VAC at 0.7A, typ
Inrush Current	115 VAC at 30A, typ	230 VAC at 50A, typ

Output Specifications

Voltage Accuracy	±2%
Line Regulation (full load)	±0.5%, typ
Load Regulation (5-100%)	±1%, typ
Ripple and Noise (20Mhz bandwidth)	150mV pk-pk, max
Short Circuit Protection	Continuous, auto resume
Over Current Protection	110-150% , auto resume
Over Voltage Protection	Zener Diode Clamp
Min Load	1%
Trim	10%

Common Specifications

Temperature range	-40 °C to +70 °C	
Power derating	3% / °C (output: 05, 09 VDC) 2.5% / °C (output: 12,15,24,48 VDC)	
Storage	-40 °C to +85 °C	
Hold up Time	15mS, typ. at 115VAC	80mS, typ at 230VAC
Humidity	95%, max.	
Temperature Coefficient	± 0.02%/°C	
Switching Frequency	100kHz, typ	
I/O Isolation Voltage	4000VAC / 1min.	
Safety Standards	IEC60950, EN60950, UL60950	
Safety Approvals	pending	
Safety Class	CLASS I	
Hot swap	Forbid	
Case Material	UL94V-0 rated	
Install	PCB	
Cooling	Free air convection	
Reliability Calculated MTBF (MIL-HDBK-217F)	> 200,000 hrs	
Weight	~ 310g	

Selection Guide

Single Output

Order #	Power (W)	Output Voltage (Vdc)	Output Current Full Load (mA)	Efficiency (%)	Capacitor Load (uF)	Standby Power, max
SINGLE OUTPUT						
PPM50-G-05ELF	50	5	10000	82	80000	0.5W
PPM50-G-09ELF	50	9	6600	84	28000	0.5W
PPM50-G-12ELF	50	12	5000	86	14000	0.5W
PPM60-G-15ELF	60	15	4000	86	12000	0.5W
PPM60-G-24ELF	60	24	2500	86	4000	0.5W
PPM60-G-48ELF	60	48	1250	86	1000	0.5W

If you need other specifications, please enquire.

Package / Pinning / Derating

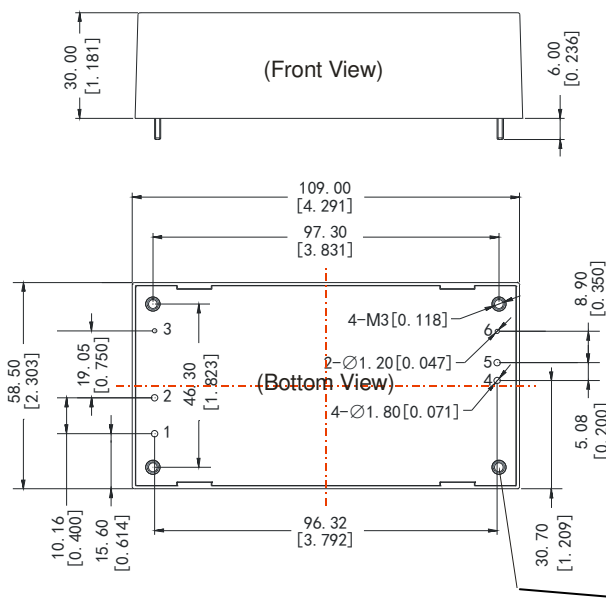

Note:
 Unit: mm (inch)
 Pin 1, 2, 4, 5's diameter: 1.80mm, Pin 3, 6's diameter: 1.20mm

All dimensions are typical in millimeters (inches)
 - Pin diameter: ± 0.05 (0.04 ± 0.002)
 - Pin pitch tolerance: ± 0.35 (± 0.014)
 - Case tolerance: ± 0.5 (± 0.02)
 Specification may change without notice

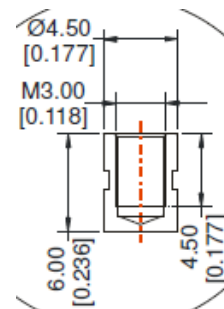

PIN CONNECTIONS	
#	SINGLE
1	AC (N)
2	AC (L)
3	FG
4	+ Vo
5	-Vo
6	Trim

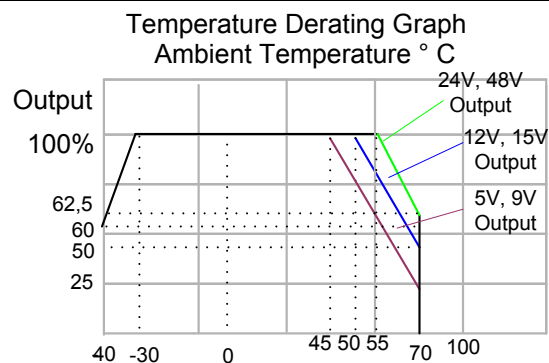

App Notes:

Trim Application & Trim Calculation

Application circuit for TRIM
(Part in broken line is the interior of models)

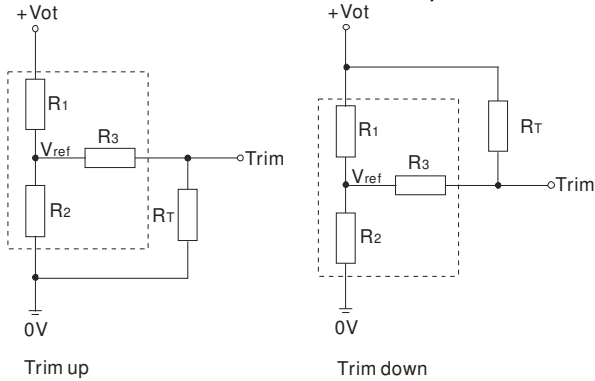

Formula for resistance of Trim :

$$\text{up: } R_T = \frac{aR_2}{R_2 - a} - R_3 \quad a = \frac{V_{ref}}{V_{ot} - V_{ref}} \cdot R_1$$

$$\text{down: } R_T = \frac{aR_1}{R_1 - a} - R_3 \quad a = \frac{V_{ot} - V_{ref}}{V_{ref}} \cdot R_2$$

Note: Value for R1, R2, R3, and Vref refer to the following table.

R_T: Resistance of Trim

a: User-defined parameter, no actual meanings.

Vo(V) Resistance	5	9	12	15	24	48
R1(KΩ)	3.3	4.7	3.83	7.5	8.66	33
R2(KΩ)	3.3	1.8	1	1.5	1	1.8
R3(KΩ)	1	1	1	1	1	1
Vref(V)	2.5	2.5	2.5	2.5	2.5	2.5
Vot(V)	Output voltage of Trim, variation ≤ ±10%					

EMC

EMI	EN55022, level B		
EMS	ESD	IEC/EN 61000-4-2 ±6kV/8kV	perf. Criteria B
	RS	IEC/EN 61000-4-3 10V/m	perf. Criteria A
	EFT	IEC/EN 61000-4-4 ±4kV	perf. Criteria B
	Surge	IEC/EN 61000-4-5 ±2kV/4kV	perf. Criteria B
	CS	IEC/EN 61000-4-6 10 Vr.m.s.	perf. Criteria A
	PFM	IEC/EN 61000-4-8 10A/m	perf. Criteria A
Voltage dips, short and interruption immunity	IEC/EN 61000-4-11	95% 5000ms	perf. Criteria B

Parallel Lines Measure

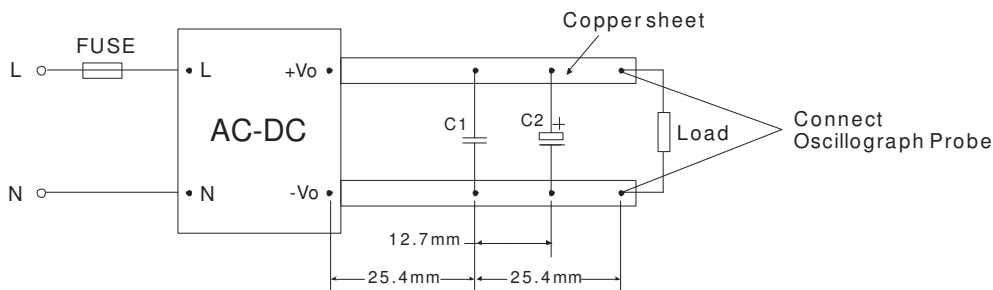

Note: C1: 1μF (Ceramic capacitor) C2: 10μF (Electrolytic capacitor)

App Notes:

Typical Applications PPM-Series

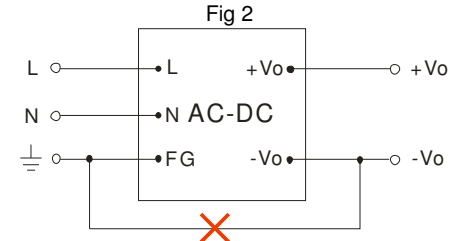
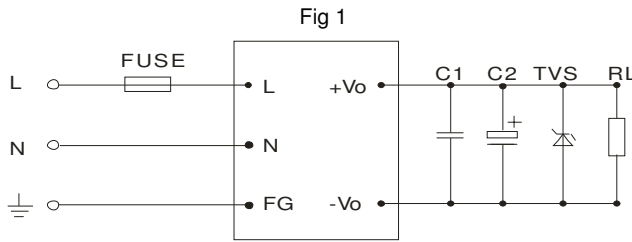

Note: This application is not supported for this series.

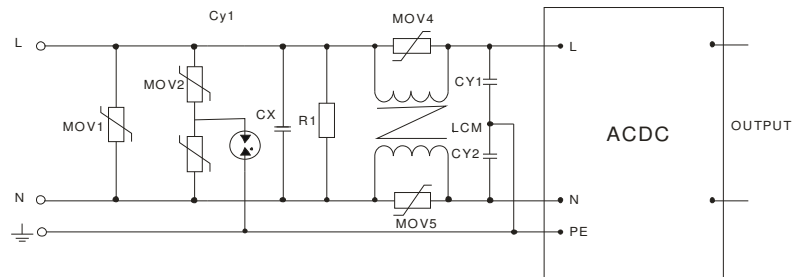

External Typical Value

Model	C1	C2	TVS
PPM50-G-05ELF	1 μ F	680 μ F	SMBJ7.0A
PPM50-G-09ELF		470 μ F	SMBJ12A
PPM50-G-12ELF		330 μ F	SMBJ20A
PPM60-G-15ELF		330 μ F	SMBJ30A
PPM60-G-24ELF		200 μ F	SMBJ30A
PPM60-G-48ELF		100 μ F	SMBJ64A

Note

- Output filtering capacitors C2 is electrolytic capacitors. It is recommended to use high frequency and low impedance electrolytic capacitors. For capacitance and current of capacitor, please refer to manufacture's datasheet. Voltage derating of capacitor should be 80% or above. C1 is ceramic capacitor - it is used to filter high frequency noise. TVS is a recommended component to protect post-circuits (if converter fails).
- External connect FUSE, recommended the parameter is 3.15A/250V slow blow.

Figure 3: MOV1: 561KD14; MOV2, MOV3: 561KD14; MOV4, MOV5: 561KD07;
 CX: 0.15 μ F/300VAC; CY1, CY2: 2200pF/400VAC; R1: 1M Ω /2W;
 NTC: 5D-9;
 FUSE: Recommended to use 3.15A/250V slow blow.