

MAX20328A Evaluation Kit

Evaluates: MAX20328A, MAX20328

General Description

The MAX20328A evaluation kit (EV kit) is a fully assembled and tested circuit for evaluating the MAX20328/MAX20328A MUX switch for USB-C audio adapter applications. The device features automatic MIC-GND orientation and headphone impedance detection, Beyond-the-Rails™ signal capability, and surge protection on pins attached to the USB-C connector. This EV kit enables fast and easy evaluation of the MAX20328/MAX20328A switches in USB-C audio applications.

The EV kit is populated with MAX20328A. The MAX20328 and MAX20328A are pin-to-pin and register compatible. Users can install their own MAX20328 for evaluation.

Features

- Automatic MIC/GND Orientation Detection
 - MIC Line Bias Check Safeguards Against Shorting MIC to GND
- 3.5mm Audio Jack for Testing with Audio Signals
- Onboard USB Receptacles for Passing and Measuring Data Signals
- Proven PCB Layout
- Fully Assembled and Tested

Ordering Information appears at end of data sheet.

Beyond-the-Rails is a trademark of Maxim Integrated Products, Inc.

Quick Start

Required Equipment

The following equipment is required to verify the basic functionality of this EV kit:

- 5V capable power supply
- Host device with I²C communication support
- DMM or continuity tester

Optional Equipment

The following equipment can be used for more complete testing of this EV kit:

- USB Flash drive or other device with a USB-A male connector
- USB A-to-B cable
- USB C cable
- TRRS 3.5mm audio cable
- TRRS 3.5mm audio device with 3.5mm to USB-C passive adapter

Procedure

The EV kit is fully assembled and tested. Follow the steps below to verify board operation:

- 1) Verify the positions of the configuration resistor pairs R1 and R2, R4 and R5, and R6 and R8.
 - a) For evaluating MAX20328, R1, R4, and R6 should be installed.
 - b) For evaluating MAX20328A, R2, R5, and R8 should be installed.
- 2) Verify shunts are installed on jumpers JU1 and on JU3 in the 1-2 position. JU3 selects the source of the V_{CC} supply.
- 3) Connect the positive lead of a 2.7 to 5V power supply to TP12 and the negative lead to TP14, then safely turn on the supply.
- 4) Connect SCL of the I²C device to TP16 and SDA to TP17; or use the 40-pin connector.
- 5) Read register 0x00 using the I²C read address 0x2B. If the data read matches the DEVICE_ID value of the installed device (Table 5 of the MAX20328/MAX20328A data sheet), the EV kit is configured correctly.

To test automatic audio headset detection and switch configuration, use the following procedure:

- 1) After establishing communication with the EV kit device, verify that automatic headset detection is enabled. Enable it if needed.
- 2) Supply an audio signal to the 3.5mm jack J7 on the EV kit.
- 3) Insert a TRRS headset with USB-C passive adapter (this will not work for active adapters) and verify the audio signal is routed to the headset.

Detailed Description of Hardware

The MAX20328A EV kit is a fully assembled and tested PCB for evaluating the MAX20328 and MAX20328A USB-C audio MUX switches. Although the MAX20328 and MAX20328A have slightly different features, the same hardware can be used to evaluate both devices. By installing combinations of 0Ω resistors, the signals will be routed correctly for the selected device.

Hardware Connectors

The MAX20328A EV kit contains several USB connectors and a 3.5mm audio jack to conveniently check the functionality of different signal paths.

USB Connectors

A USB-C female connector connects to the top- (DP_T, DM_T) and bottom-side (DP_B, DM_B) D+/D- data lines, SBU lines, and the CC2 pin to the MAX20328/MAX20328A as they would in a typical application. Alternatively, two USB-B female connectors are also available to provide these signals independently. J2 connects to DP_B and DM_B, and J4 connects to DP_T and DM_T.

Two USB-A female connectors allow for testing data transfer to a USB flashdrive or similar device with a USB-A male connector. J1 connects to the bottom side data pins and J6 connects to the top side data pins.

3.5mm Audio Jack

The EV kit also includes a 3.5mm jack for evaluating the audio signal routing action. The TRRS jack J7 simplifies injecting an audio signal into the EV kit. When a 3.5mm audio headset is detected on the USB-C input by means of a passive adapter, the signal coming into J7 will be routed to the USB-C connector and the headset.

Table 1. Jumper Configurations

JUMPER	SHUNT POSITION	DESCRIPTION
JU1	Installed*	Connects V _{CC} of the device to the EV kit supply.
	Not Installed	V _{CC} of the device disconnected from EV kit supply.
JU2	Installed	Attaches a 3.92kΩ pullup resistor to V _{CC} on $\overline{\text{INT}}$ of the MAX20328A.
	Not Installed*	No pullup on MAX20328A $\overline{\text{INT}}$ pin.
JU3	1-2*	Connects EV kit supply to TP12 for an external supply voltage.
	2-3	Connects EV kit supply to the 3.3V line of the 40-pin connector.
JU4	Installed	Connects a 3.92kΩ pullup resistor from SCL to the 3.3V line of the 40-pin connector.
	Not Installed*	No pullup on SCL to 3.3V line.
JU5	Installed	Connects a 3.92kΩ pullup resistor from SDA to the 3.3V line of the 40-pin connector.
	Not Installed*	No pullup on SDA to 3.3V line.
JU6	1-2*	Ties U1 CC pin to V _{CC} through a 10kΩ pullup resistor. Leave open or shunt 1-2 to use J3 CC.
	2-3	Ties U1 CC pin to ground. Leave open or shunt 1-2 to use J3 CC.
JU7	Installed*	J3 CC is connected to U1 CC and pulled to voltage selected by JU6.
	Not Installed	U1 CC is floating or tied to voltage selected by JU6.
JU8	Installed*	Connects GSNS_L (MAX20328) or GSNS (MAX20328A) to AGND.
	Not Installed	GSNS_L (MAX20328) or GSNS (MAX20328A) not connected to AGND.
JU9	Installed	Connects GSNS_R (MAX20328) to AGND.
	Not Installed*	Connects GSNS_R (MAX20328) to AGND.

*Default position

Table 2. Test Point Assignments

TEST POINT	SIGNAL
TP1	MIC
TP2	AGND
TP3	LA
TP4	RA
TP5	GSNS_L (MAX20328) or GSNS (MAX20328A)
TP6	GSNS_R (MAX20328 only)
TP7	TX (MAX20328A only)
TP8	V _{CC} of U1
TP9	Ground
TP10	RX (MAX20328A only)

TEST POINT	SIGNAL
TP11	$\overline{\text{INT}}$ (MAX20328A only)
TP12	External supply connection
TP13	V _{CC} of EV kit board
TP14	Ground
TP15	Ground
TP16	SCL
TP17	SDA
TP18	CC2 pin of connector J3. Connects to CC of MAX20328/MAX20328A if a shunt is present on JU7.

Ordering Information

PART	TYPE
MAX20328AEVKIT#	EV Kit

#Denotes RoHS compliant.

MAX20328A EV Kit Bill of Materials

ITEM	REF_DES	DNI/D NP	QTY	MFG PART #	MFG	VALUE	DESCRIPTION
1	C1-C4	-	4	0603YD105KAT2A; CL10A105K08NNN	AVX;SAMSUNG ELECTRO-MECHANICS	1UF	CAPACITOR; SMT (0603); CERAMIC CHIP; 1UF; 16V; TOL=10%; TG=-55 DEGC TO +85 DEGC; TC=X5R
2	J1, J6	-	2	8752D-0010BLF	FCI CONNECT	8752D-0010BLF	CONNECTOR; FEMALE; THROUGH HOLE; USB RECEPTACLE; RIGHT ANGLE; 4PINS
3	J2, J4	-	2	690-004-221-023	EDAC	690-004-221-023	CONNECTOR; FEMALE; THROUGH HOLE; USB-B TYPE; SINGLE DECK; RIGHT ANGLE; 4PINS
4	J3	-	1	898-73-024-90-310001	MILL-MAX	898-73-024-90-310001	CONNECTOR; FEMALE; SMT; -RIGHT ANGLE; 24PINS
5	J5	-	1	SBH11-PBPC-D20-ST-BK	SULLINS ELECTRONICS CORP.	SBH11-PBPC-D20-ST-BK	CONNECTOR; MALE; THROUGH HOLE; HEADER CONNECTOR; STRAIGHT; 40PINS; EDGE FOOTPRINT
6	J7	-	1	SJ-435107RS	CUI INC.	SJ-435107RS	CONNECTOR; FEMALE; THROUGH HOLE; SJ-435107 SERIES; 3.5MM AUDIO JACK; RIGHT ANGLE; 6PINS
7	JU1, JU2, JU4, JU5, JU7, JU9	-	7	68000-102HLF	FCI CONNECT	68000-102HLF	CONNECTOR; MALE; THROUGH HOLE; 6800 SERIES; BERGSTIK II HEADER; STRAIGHT; 2PINS
8	JU3, JU6	-	2	68001-203HLF	FCI CONNECT	68001-203HLF	CONNECTOR; MALE; THROUGH HOLE; BERGSTIK BREAKAWAY HEADER; STRAIGHT; 3PINS
9	LED1-LED4	-	4	SML-LX1206GW-TR	LUMEX	SML-LX1206GW-TR	DIODE; LED; STANDARD; GREEN; SMT (1206); PIV=2.2V; IF=0.02A; -40 DEGC TO +85 DEGC
10	R2, R5, R8	-	3	RC0805JR-070RL	OPTOCOMPONENTS INC	0	RESISTOR; 0805; 0 OHM; 5%; JUMPER; 0.125W; THICK FILM
11	R3, R9-R11	-	4	CR0W08051K00FK; ERJ-6ENF1001V; MCR10EZH1001; RC0805FR-071KL	VISHAY DALE; PANASONIC; ROHM; YAGEO	1K	RESISTOR; 0805; 1K; 1%; 100PPM; 0.125W; THICK FILM
12	R7, R12, R13	-	3	CR0W080510K0FK; MCR10EZH1002; RC0805FR-073K92L	VISHAY DALE; ROHM SEMI; YAGEO	3.92K	RESISTOR; 0805; 3.92K OHM; 1%; 100PPM; 0.125W; THICK FILM
13	R14	-	1	ERJ-6ENF1002V; RC0805FR-0710KL	MURATA; YAGEO	10K	RESISTOR; 0805; 10K; 1%; 100PPM; 0.125W; THICK FILM
14	TP1, TP8, TP13	-	3	5116	KEYSTONE	N/A	TEST POINT; PIN DIA=0.1IN; TOTAL LENGTH=0.3IN; BOARD HOLE=0.04IN; GREEN; PHOSPHOR BRONZE WIRE SILVER PLATE FINISH;
15	TP2	-	1	5118	KEYSTONE	N/A	TEST POINT; PIN DIA=0.1IN; TOTAL LENGTH=0.3IN; BOARD HOLE=0.04IN; GREY; PHOSPHOR BRONZE WIRE SILVER PLATE FINISH;
16	TP3, TP7, TP16, TP18	-	4	5004	KEYSTONE	N/A	TEST POINT; PIN DIA=0.1IN; TOTAL LENGTH=0.3IN; BOARD HOLE=0.04IN; YELLOW; PHOSPHOR BRONZE WIRE SILVER PLATE FINISH;
17	TP4, TP10	-	2	5000	KEYSTONE	N/A	TEST POINT; PIN DIA=0.1IN; TOTAL LENGTH=0.3IN; BOARD HOLE=0.04IN; RED; PHOSPHOR BRONZE WIRE SILVER PLATE FINISH;
18	TP5	-	1	5117	KEYSTONE	N/A	TEST POINT; PIN DIA=0.1IN; TOTAL LENGTH=0.3IN; BOARD HOLE=0.04IN; BLUE; PHOSPHOR BRONZE WIRE SILVER PLATE FINISH;
19	TP6, TP11, TP17	-	3	5003	KEYSTONE	N/A	TEST POINT; PIN DIA=0.1IN; TOTAL LENGTH=0.3IN; BOARD HOLE=0.04IN; ORANGE; PHOSPHOR BRONZE WIRE SILVER PLATE FINISH;
20	TP9, TP14, TP15	-	3	5011	KEYSTONE	N/A	TEST POINT; PIN DIA=0.125IN; TOTAL LENGTH=0.445IN; BOARD HOLE=0.063IN; BLACK; PHOSPHOR BRONZE WIRE SILVER PLATE FINISH;
21	TP12	-	1	5010	KEYSTONE	N/A	TEST POINT WITH 1.80MM HOLE DIA; RED; MULTIPURPOSE;
22	U1	-	1	MAX20328EWA+	MAXIM	MAX20328EW	EVKIT PART - IC; INFC; MUX SWITCH FOR USB TYPE-C; AUDIO ADAPTER
23	PCB	-	1	MAX20328A	MAXIM	PCB	ACCESSORIES; WLP25; PKG. CODE: W25R2+2; PKG. OUTLINE: 21-100208 PCB; MAX20328A
24	R1, R4, R6	DNP	0	RC0805JR-070RL	YAGEO PHYCOMP	0	RESISTOR; 0805; 0 OHM; 5%; JUMPER; 0.125W; THICK FILM
TOTAL			55				

MAX20328A EV Kit Schematic

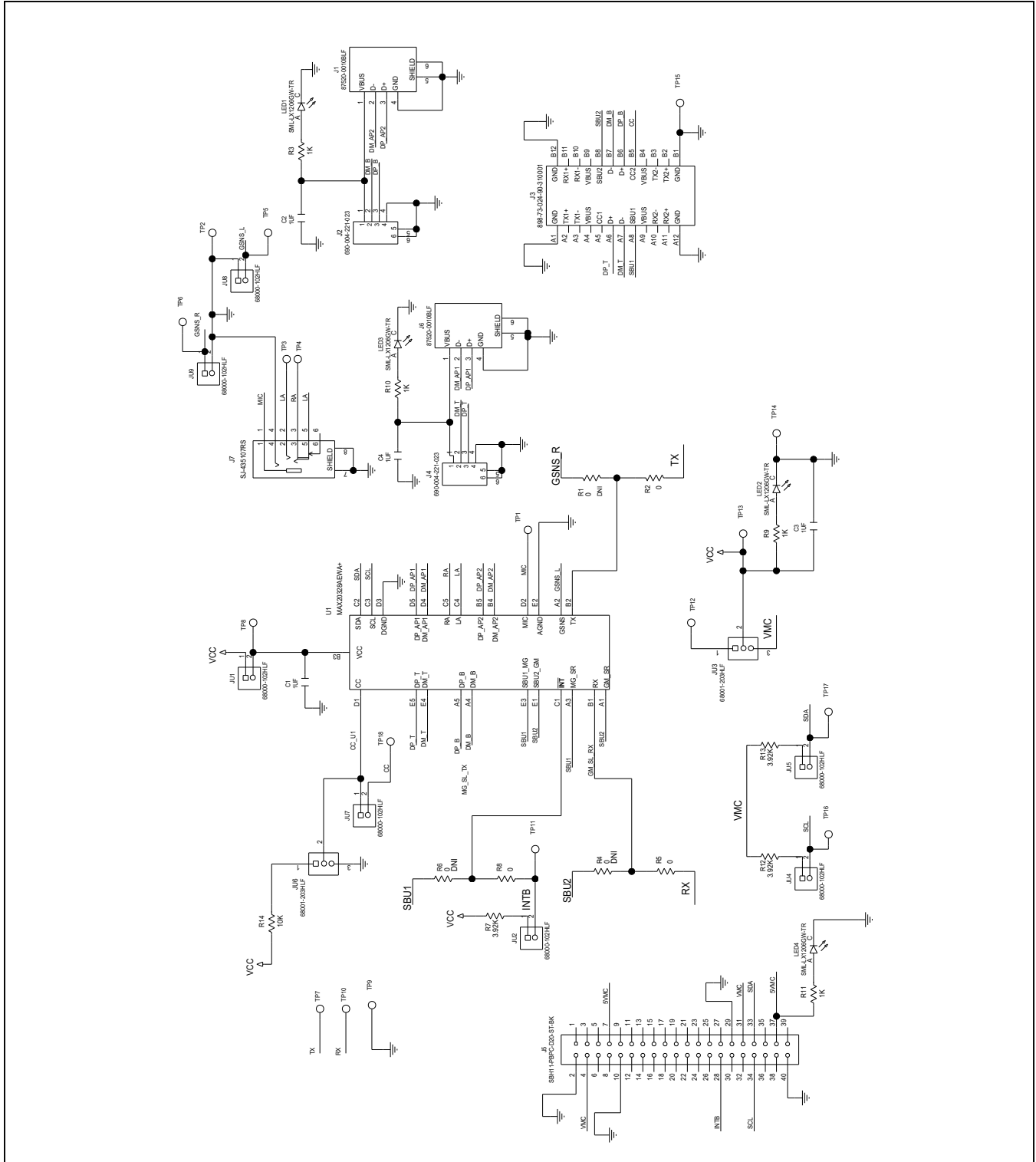

MAX20328A EV Kit PCB Layout Diagrams

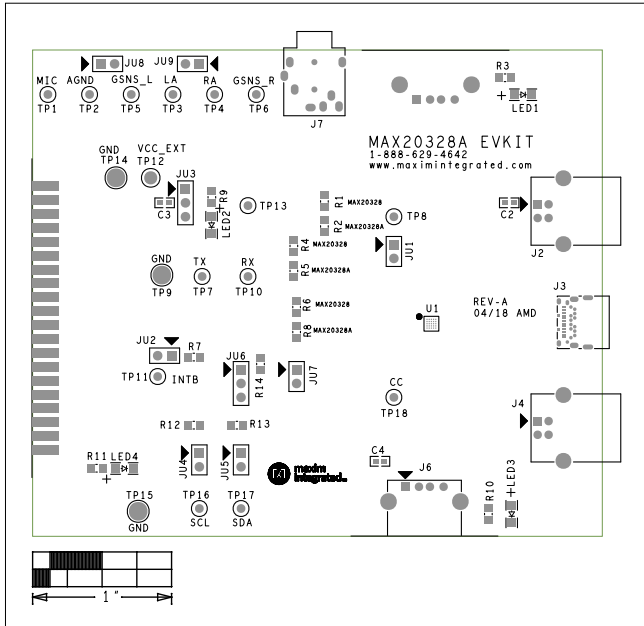

MAX20328A EV Kit—Top Silkscreen

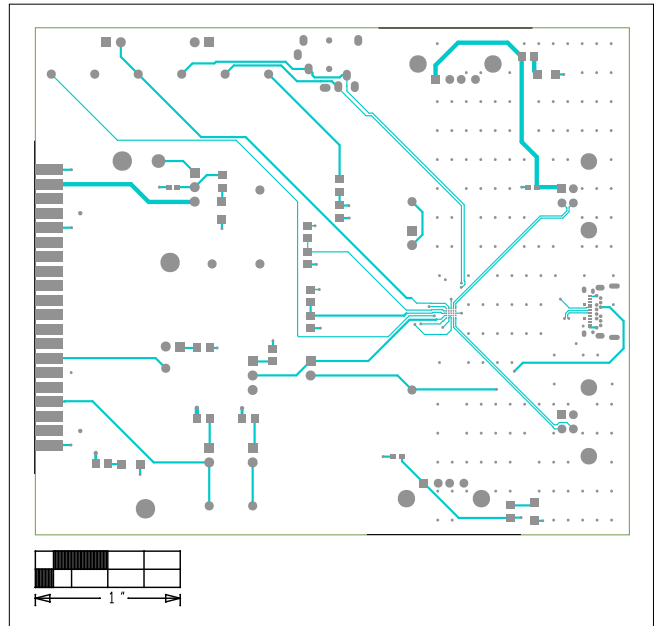

MAX20328A EV Kit—Top

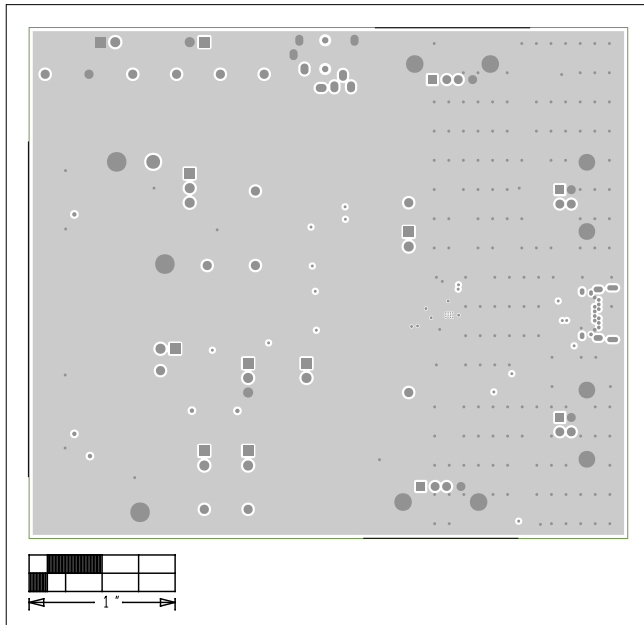

MAX20328A EV Kit—Layer 2

MAX20328A EV Kit PCB Layout Diagrams (continued)

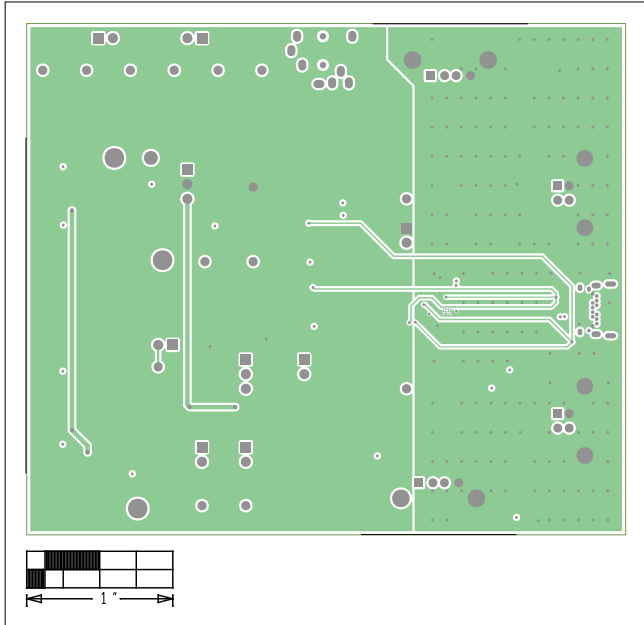

MAX20328A EV Kit—Layer 3

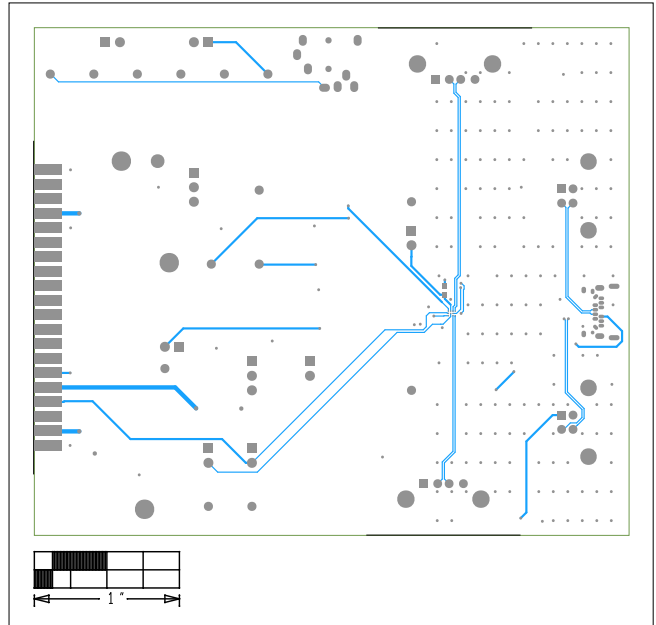

MAX20328A EV Kit—Bottom

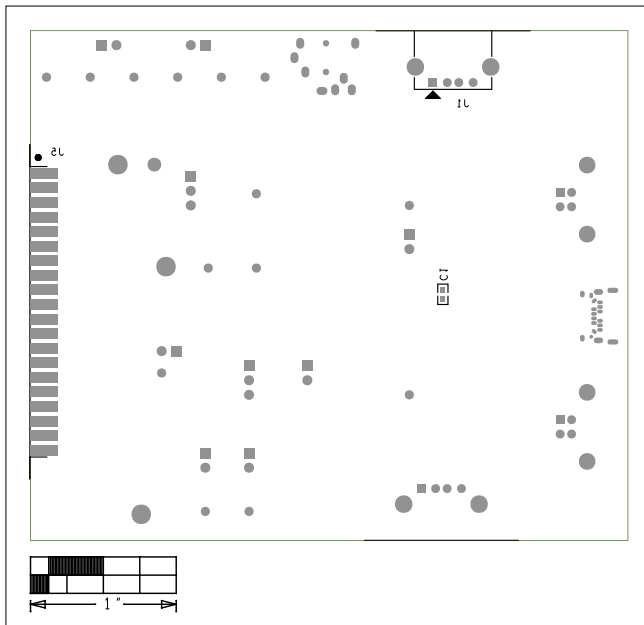

MAX20328A EV Kit—Bottom Silkscreen

Revision History

REVISION NUMBER	REVISION DATE	DESCRIPTION	PAGES CHANGED
0	5/18	Initial release	—

For pricing, delivery, and ordering information, please contact Maxim Direct at 1-888-629-4642, or visit Maxim Integrated's website at www.maximintegrated.com.

Maxim Integrated cannot assume responsibility for use of any circuitry other than circuitry entirely embodied in a Maxim Integrated product. No circuit patent licenses are implied. Maxim Integrated reserves the right to change the circuitry and specifications without notice at any time.