

800mA, 2V-6.5V Input, 1.5MHz

Synchronous Step-Down Converter

LR8503 Series

■ **INTRODUCTION:**

The LR8503 is a constant frequency, current mode step-down converter. The device integrates a main switch and a synchronous rectifier for high efficiency without an external Schottky diode. It is ideal for powering portable equipment that runs from a single cell Lithium-Ion (Li+) battery. The output voltage can be regulated as low as 0.6V. The LR8503 can also run at 100% duty cycle for low dropout operation, extending battery life in portable system. This device offers two operation modes, PWM control and PFM Mode switching control, which allows a high efficiency over the wider range of the load. The LR8503 is offered in a low profile 5-pin, SOT package, and is available in an adjustable version.

■ **APPLICATIONS:**

- Cellular and Smart Phones
- PDAs
- Wireless and DSL Modems

■ **PIN CONFIGURATION:**

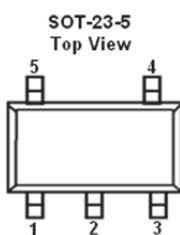

■ **FEATURES:**

- High efficiency :Up to 96%
- 1.5MHz Constant Frequency Operation
- 800mA Output Current
- No Schottky Diode Required
- 2V to 6.5V Input Voltage Range
- Output Voltage as Low as 0.6V
- PFM Mode for High Efficiency in Light Load
- 100% Duty Cycle in Dropout Operation
- Low Quiescent Current: 20µA
- Slope Compensated Current Mode Control for Excellent Line and Load Transient Response
- Short Circuit Protection
- Thermal Fault Protection
- Inrush Current Limit and Soft Start
- <1µA Shutdown Current
- SOT23-5 package

- Digital Still and Video Cameras
- DTV
- Portable Instruments

■ **ORDER INFORMATION:**

LR8503①②

DESIGNATOR	SYMBOL	DESCRIPTION
①	A	Standard
②	M	Package: SOT23-5

Tabel1. Pin Description

PIN NUMBER	PIN NAME	FUNCTION
M		
1	EN	Chip Enable Pin. Drive EN above 1.5V to turn on the part. Drive EN below 0.3V to turn it off. Do not leave EN floating
2	V _{SS}	Analog Ground Pin
3	SW	Power Switch Output. It is the switch node connection to Inductor. This pin connects to the drains of the internal P-ch and N-ch MOSFET switches.
4	V _{IN}	Power Supply Input. Must be closely decoupled to GND with a 4.7μF or greater ceramic capacitor.
5	FB	Output Voltage Feedback Pin. An internal resistive divider divides the output voltage down for comparison to the internal reference voltage.

■ ABSOLUTE MAXIMUM RATINGS(Note1)

PARAMETER	SYMBOL	RATINGS	UNITS
Input Voltage	V _{IN}	V _{SS} -0.3~V _{SS} +7.5	V
CE,SW,FB/V _{OUT} Voltage		V _{SS} -0.3~V _{IN} +0.3	V
Power Dissipation	SOT23-5 P _D	400	mW
Operating Temperature	T _{opr}	-40~+85	°C
Junction Temperature	T _j	150	°C
Storage Temperature	T _{stg}	-40~+125	°C
Soldering Temperature & Time	T _{solder}	260°C, 10s	
ESD HBM(Human Body Mode)	-	2	kV
ESD MM(Machine Mode)	-	200	V

■ ELECTRICAL CHARACTERISTICS
LR8503 Series (V_{IN}=V_{EN}=3.6V, V_{OUT}=1.8V, T_A = 25°C, unless otherwise noted.)

PARAMETER	CONDITIONS	MIN	TYP	MAX	UNITS
Input Voltage		2.0		6.5	V
Input DC Supply Current	Note 4)	-	-	-	μA
PWM Mode	V _{OUT} = 90%, I _{LOAD} =0mA	-	140	300	μA
PFM Mode	V _{OUT} = 105%, I _{LOAD} =0mA	-	20	35	μA
Shutdown Mode	V _{EN} = 0V, V _{IN} =4.2V	-	0.1	1.0	μA
Regulated Feedback Voltage VFB	T _A = 25°C	0.588	0.600	0.612	V
	T _A = 0°C ≤ T _A ≤ 85°C	0.586	0.600	0.613	V
	T _A = -40°C ≤ T _A ≤ 85°C	0.585	0.600	0.615	V
Reference Voltage Line Regulation	V _{IN} =2.7V to 5.5V	-	0.04	0.40	%/V
Output Voltage Line Regulation	V _{IN} =2.7V to 5.5V		0.04	0.40	%
Output Voltage Load Regulation			0.5		%
Oscillation Frequency	V _{OUT} =100%		1.5		MHz
	V _{OUT} =0V		300		KHZ
On Resistance of PMOS	I _{SW} =100mA		300	450	mΩ
On Resistance of NMOS	I _{SW} =-100mA		300	450	mΩ
Peak Current Limit	V _{IN} = 3V, V _{OUT} =90%		1.5		A
Turn on delay time			0.2		ms
OVP			7.3		V
EN "High" Voltage ⁽¹⁾	V _{ENH}	1.5		V _{IN}	V
EN "Low" Voltage ⁽²⁾	V _{ENL}			0.4	V
EN Leakage Current			±0.01	±1.0	μA
SW Leakage Current	V _{EN} =0V, V _{IN} =V _{SW} =5V		±0.01	±1.0	μA

Note 1: Absolute Maximum Ratings are those values beyond which the life of a device may be impaired.

Note 2: T_J is calculated from the ambient temperature T_A and power dissipation P_D according to the following formula: T_J = T_A + (P_D) x (250°C/W).

Note 3: 100% production test at +25°C. Specifications over the temperature range are guaranteed by design and characterization.

Note 4: Dynamic supply current is higher due to the gate charge being delivered at the switching frequency.

■ TYPICAL APPLICATION CIRCUITS

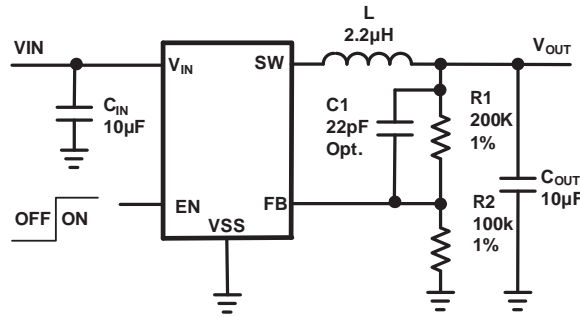
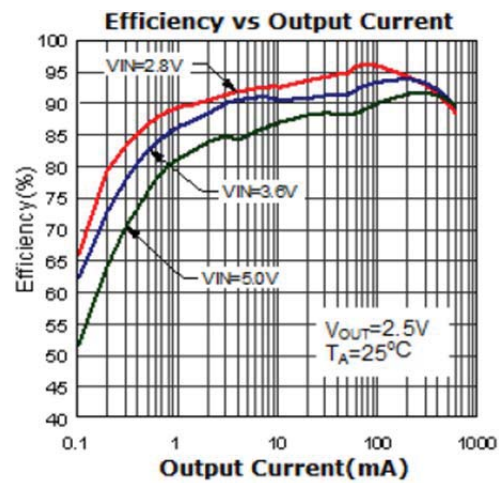
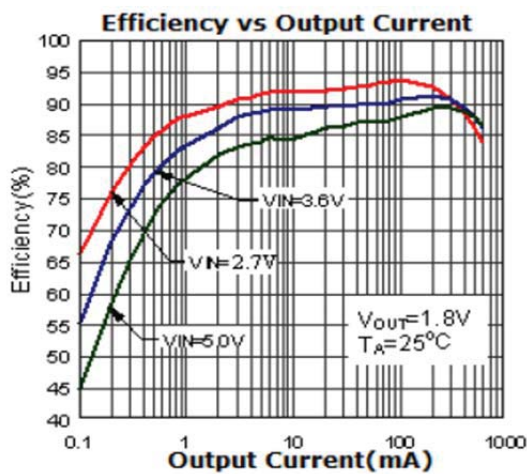
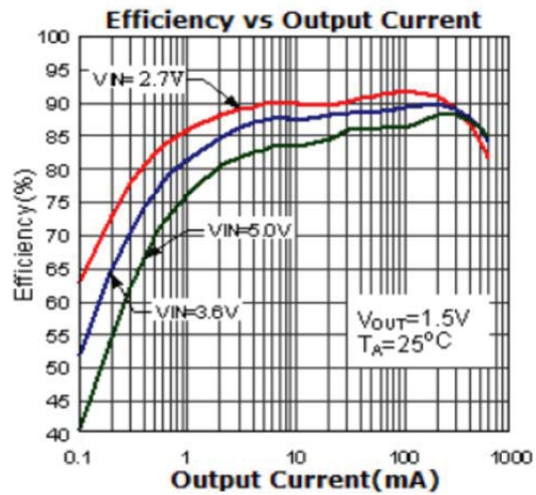
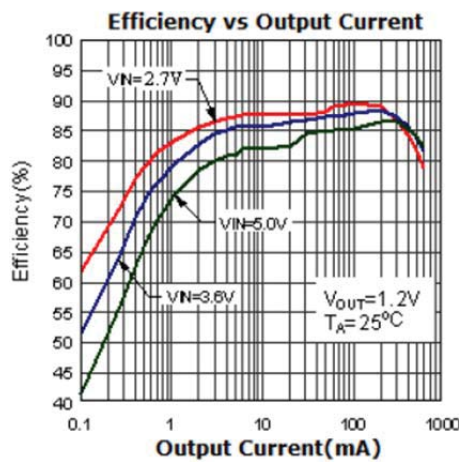
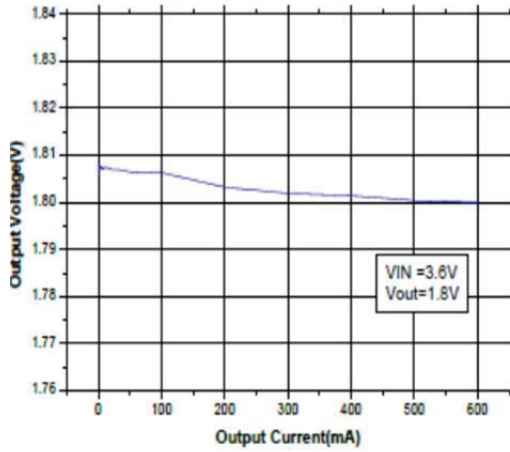
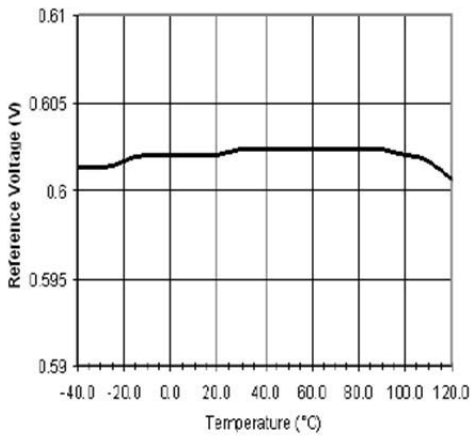
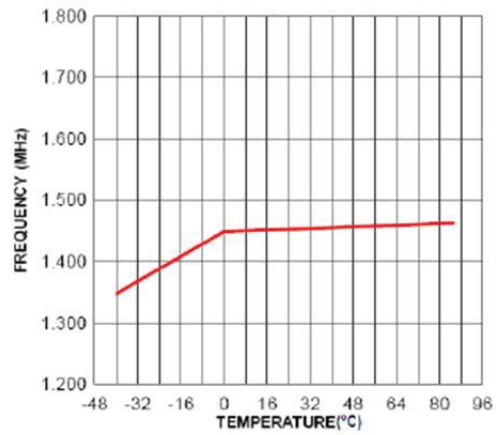
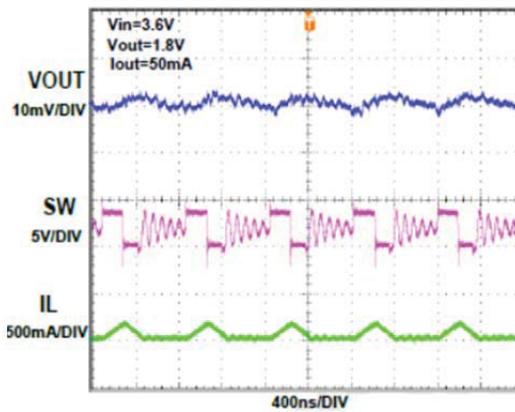
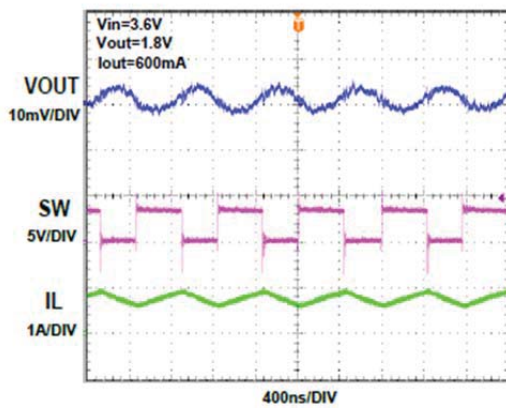
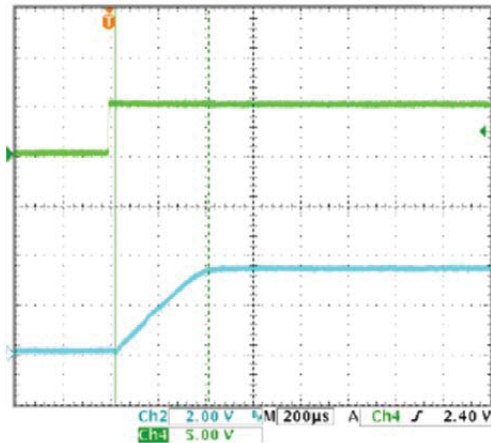

Figure1 Basic Application Circuit

Note: $V_{OUT} = V_{FB} \times \left(1 + \frac{R1}{R2}\right)$

■ TYPICAL PERFORMANCE CHARACTERISTICS
(Test Figure1 above, unless otherwise specified)

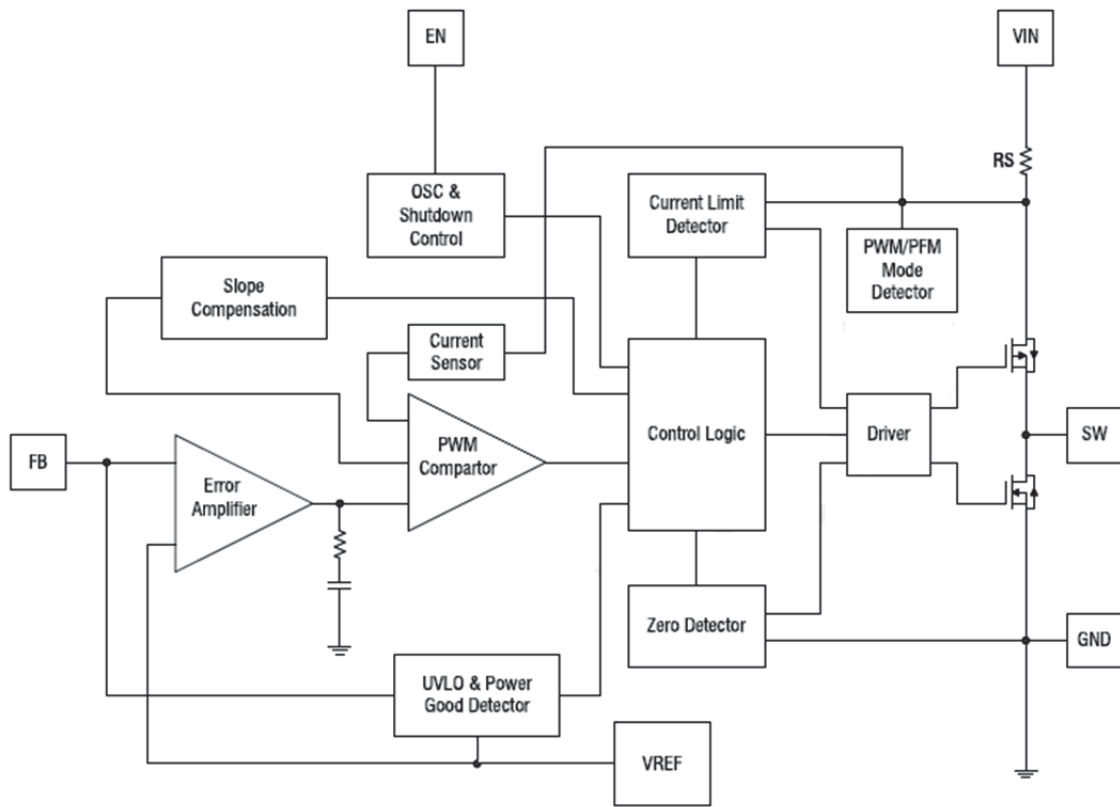

Output voltage VS Output Current

Oscillator Frequency vs Temperature

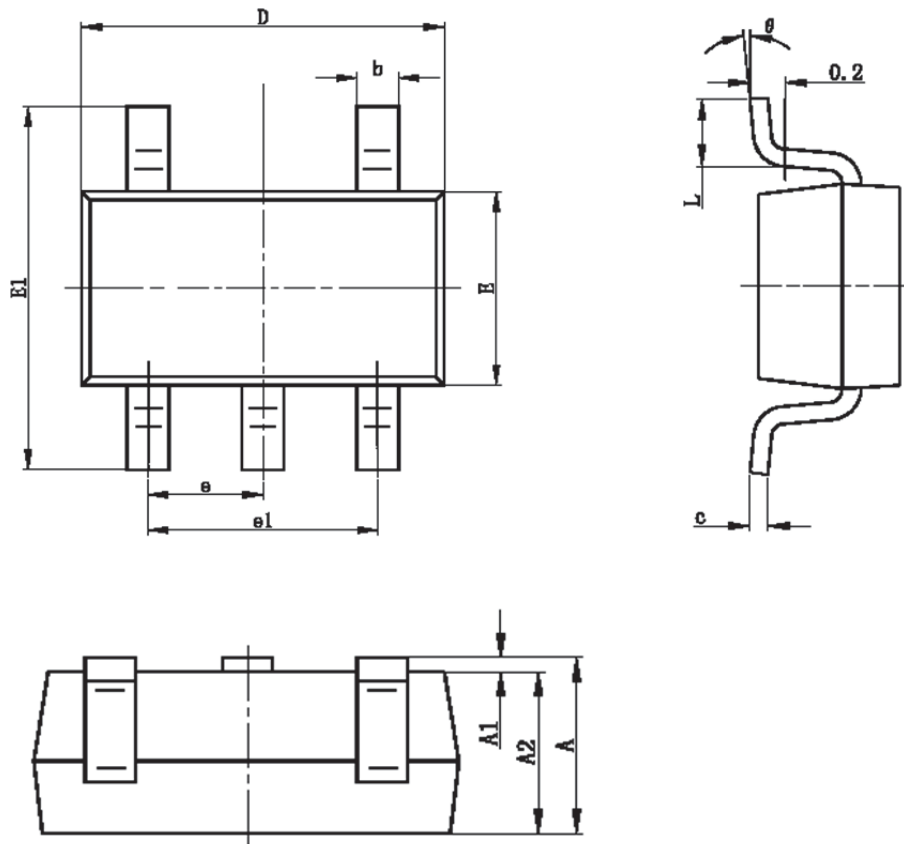
PFM MODE

PWM MODE

START UP RESPONSE

■ FUNCTIONAL BLOCK DIAGRAM**Figure2 Block Diagram**

■ PACKAGING INFORMATION
● SOT23-5 Package Outline Dimensions

Symbol	Dimensions In Millimeters		Dimensions In Inches	
	Min	Max	Min	Max
A	1.050	1.250	0.041	0.049
A1	0.000	0.100	0.000	0.004
A2	1.050	1.150	0.041	0.045
b	0.300	0.500	0.012	0.020
c	0.100	0.200	0.004	0.008
D	2.820	3.020	0.111	0.119
E	1.500	1.700	0.059	0.067
E1	2.650	2.950	0.104	0.116
e	0.950(BSC)		0.037(BSC)	
e1	1.800	2.000	0.071	0.079
L	0.300	0.600	0.012	0.024
θ	0°	8°	0°	8°