

LA4282

Audio Power Amplifier Class AB, 10W × 2-Channel



ON Semiconductor[®]
www.onsemi.com

Overview

The LA4282 is the IC for 2-channel SE power amplifier that is developed for TVs and monitors audio system. High power and low distortion are realized. This IC incorporate various functions (muting function, and various protection circuit) necessary for audio system.

Features

- High-power 2-channel AF power amplifier
- Low distortion
- Minimum number of external parts required (no bootstrap capacitor required)
- Low pop noise at the time of power supply ON/OFF
- Good ripple rejection (58dB typ)
- Wide operating voltage range
- External muting available
- On-chip protector against abnormality (thermal shutdown, overvoltage)

Typical Applications

- Home Stereo
- TV

SPECIFICATION

ABSOLUTE MAXIMUM RATINGS at Ta = 25°C (Note 1)

Parameter	Symbol	Conditions	Ratings	Unit
Maximum supply voltage	V _{CC} max	Quiescent	45	V
Maximum output current	I _O peak		4	A
Allowable power dissipation	P _d max	With heat sink	25	W
Operating temperature	T _{opr}		-20 to +75	°C
Storage temperature	T _{stg}		-40 to +150	°C

1. Stresses exceeding those listed in the Absolute Maximum Rating table may damage the device. If any of these limits are exceeded, device functionality should not be assumed, damage may occur and reliability may be affected.

RECOMMENDED OPERATING RANGE at Ta = 25°C (Note 2)

Parameter	Symbol	Conditions	Ratings	Unit
Recommended supply voltage	V _{CC}		32	V
	V _{CC op}		10 to 40	V
Recommended load resistance	R _L		8	Ω

2. Functional operation above the stresses listed in the Recommended Operating Ranges is not implied. Extended exposure to stresses beyond the Recommended Operating Ranges limits may affect device reliability.

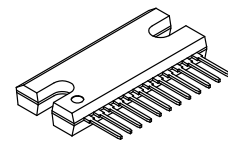

SIP12 26.8 mm x 11.8 mm

GENERIC MARKING DIAGRAM*

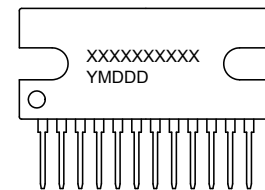

XXXXX = Specific Device Code
Y = Year
M = Month
DDD = Additional Traceability Data

*This information is generic. Please refer to device data sheet for actual part marking. Pb-Free indicator, "G" or microdot "▪", may or may not be present.

ORDERING INFORMATION

Ordering Code:
LA4282-E

Package
SIP12
(Pb-Free / Halogen Free)

Shipping (Qty / packing)
20 / Fan-Fold

† For information on tape and reel specifications, including part orientation and tape sizes, please refer to our Tape and Reel Packaging Specifications Brochure, BRD8011/D.
http://www.onsemi.com/pub_link/Collateral/BRD8011-D.PDF

LA4282

ELECTRICAL CHARACTERISTICS at $T_a = 25^\circ\text{C}$, $V_C = 32\text{V}$, $R_L = 8\ \Omega$, $f = 1\text{kHz}$, $R_g = 600\ \Omega$, See Test Circuit. (Note3)

Parameter	Symbol	Conditions	Ratings			Unit
			min	typ	max	
Quiescent current	$I_{CCO(1)}$	Quiescent	30	60	100	mA
	$I_{CCO(2)}$	Muting switch On	30	56	100	mA
Voltage gain	VG		38	40	42	dB
Voltage gain difference	'VG				1.5	dB
Output power	$P_O(1)$	THD = 1%	9.0	10.0		W
	$P_O(2)$	THD = 3%	10.0	11.5		W
Total harmonic distortion	THD	$P_O = 2\text{W}$		0.05	0.20	%
Output noise voltage	V_{NO}	$R_g = 10\text{k}\ \Omega$, BW = 20Hz to 20kHz		0.25	1.0	mV
Ripple rejection	SVRR	$R_g = 10\text{k}\ \Omega$, $f_R = 100\text{Hz}$, $V_R = 0\text{dBm}$	45	58		dB
Crosstalk	CT	$R_g = 10\text{k}\ \Omega$	45	60		dB
Muting	$V_O(MT)$	Muting switch On, $V_{IN} = 5\text{dBm}$			35	dBm

3. Product parametric performance is indicated in the Electrical Characteristics for the listed test conditions, unless otherwise noted. Product performance may not be indicated by the Electrical Characteristics if operated under different conditions.

PACKAGE DIMENSIONS

unit : mm

SIP12 26.8x11.8 / SIP12H
CASE 127AM
ISSUE A

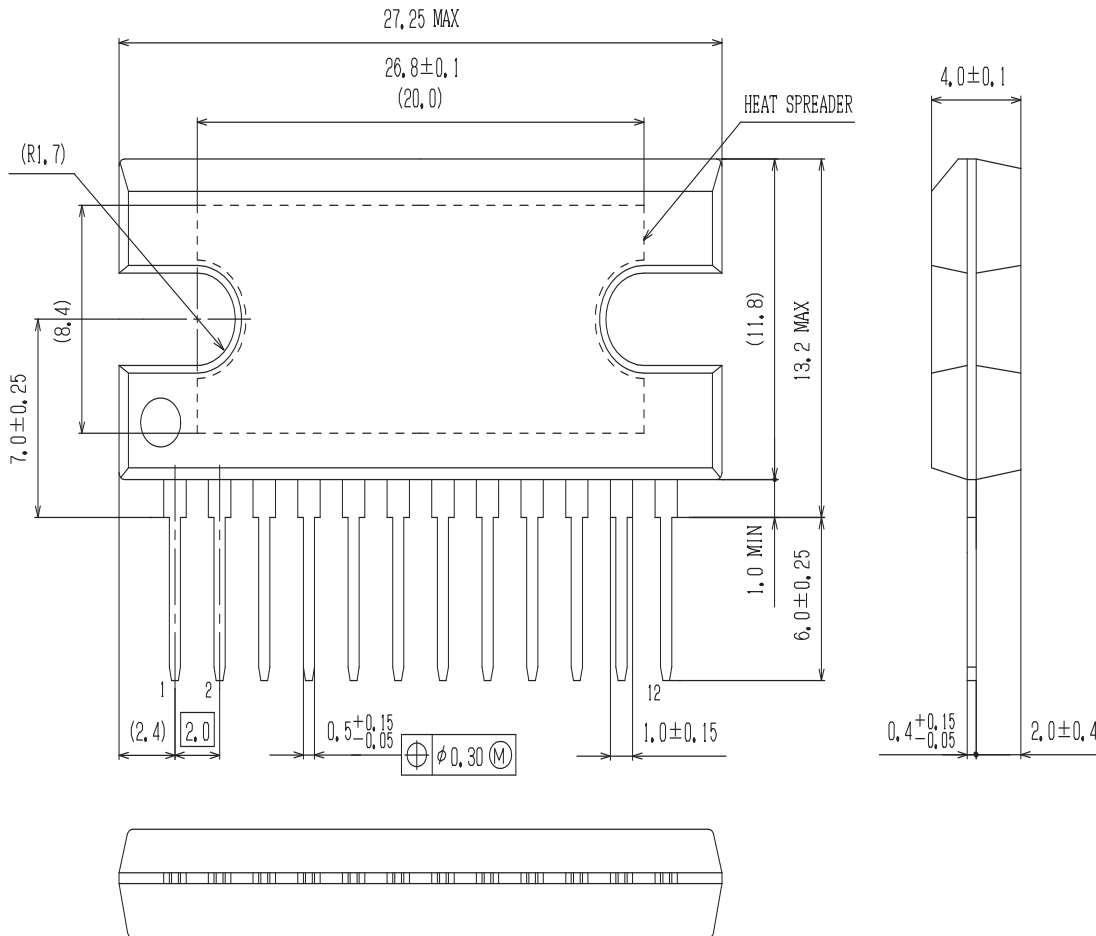

LA4282

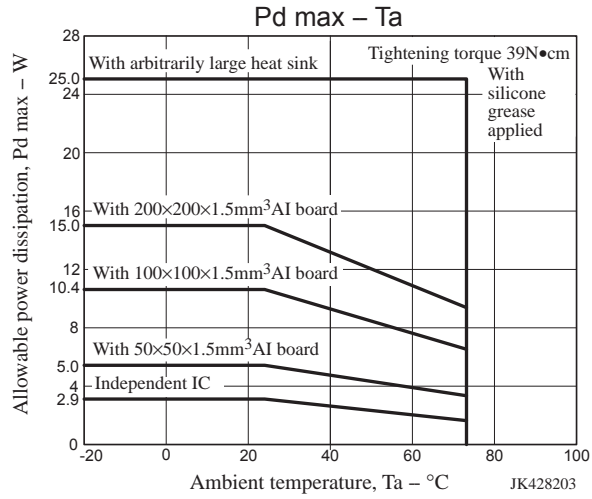

Pin Assignment and Block Diagram

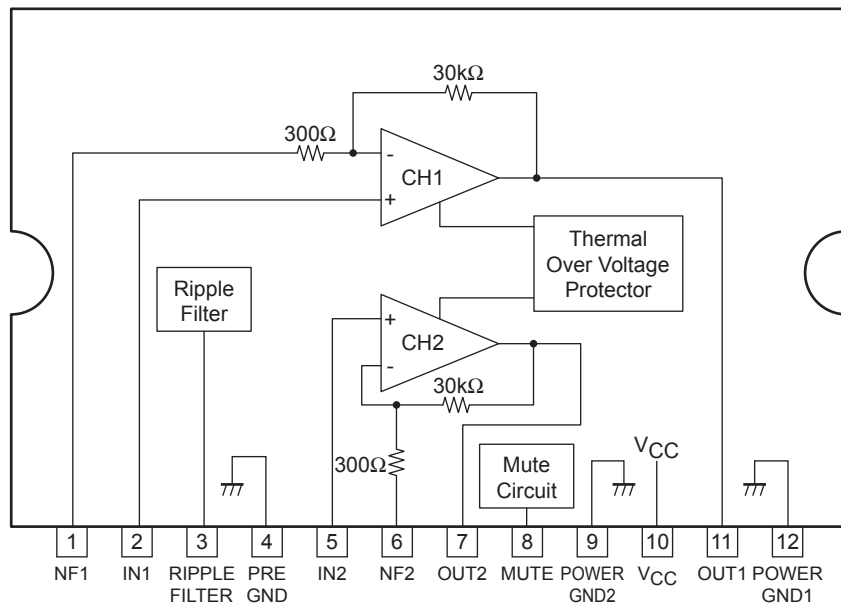

LA4282

Test Circuit

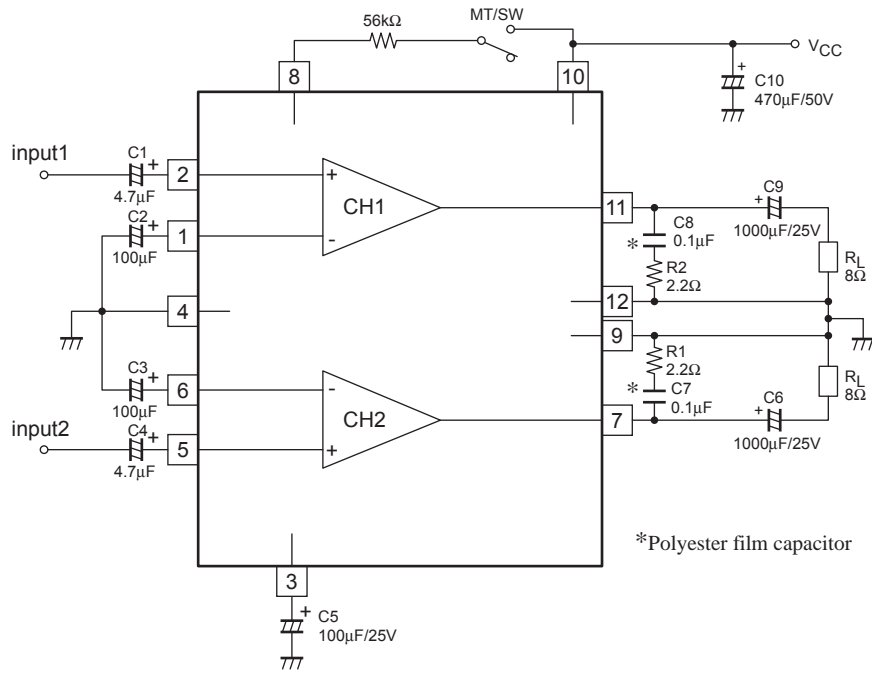

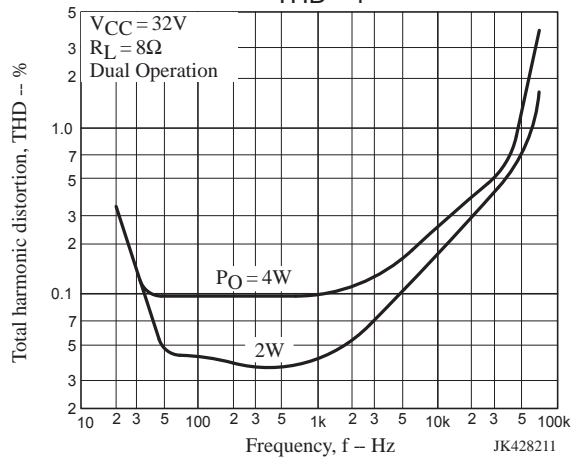
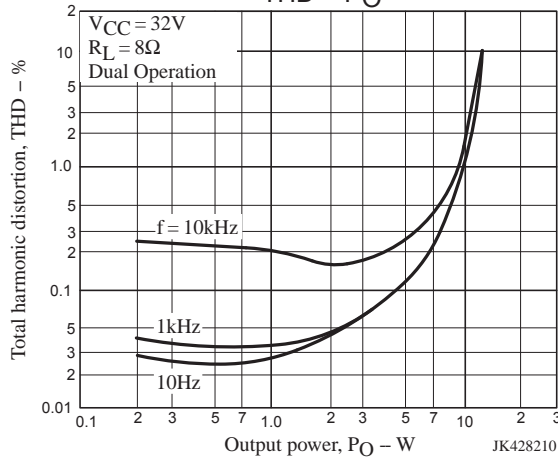
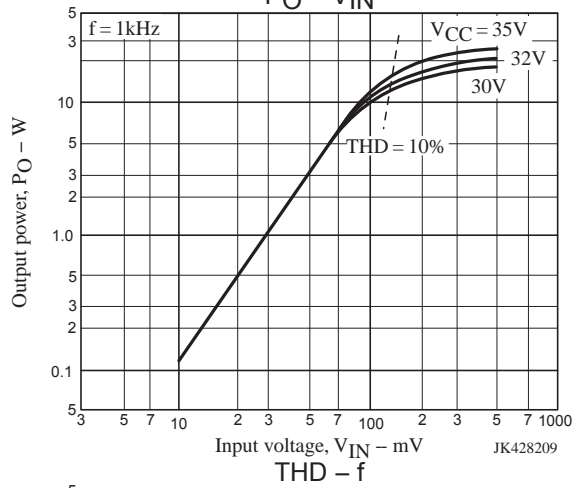
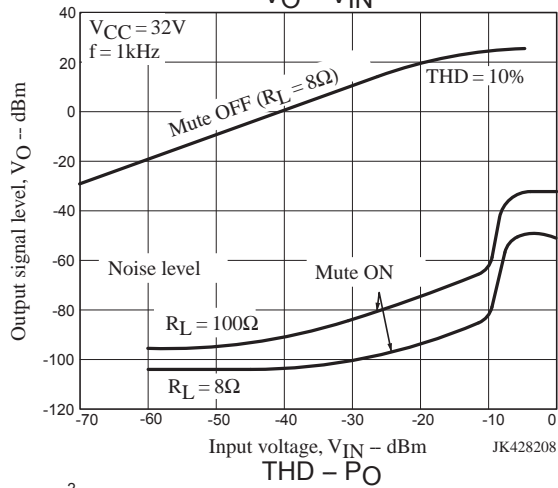
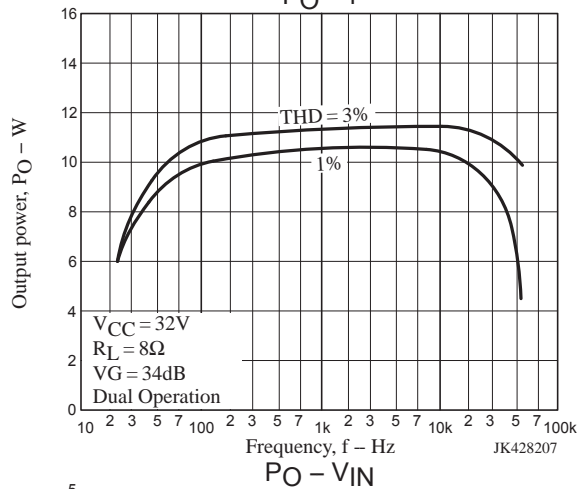
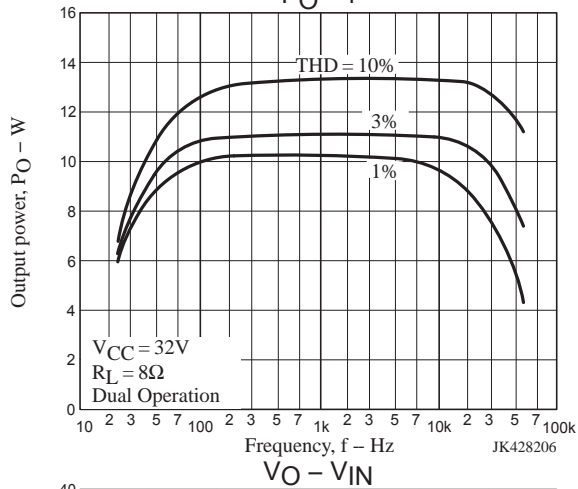
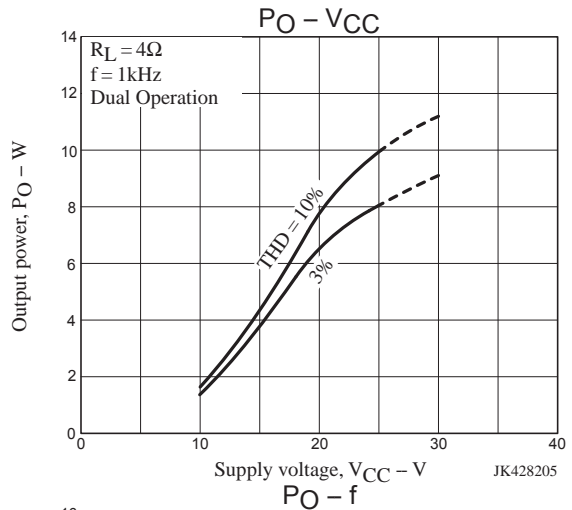
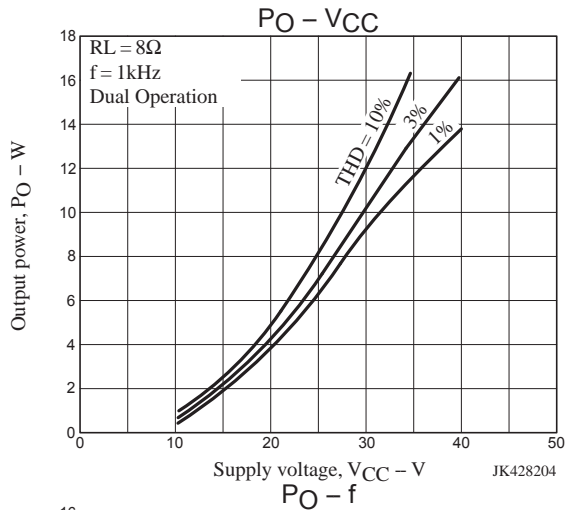

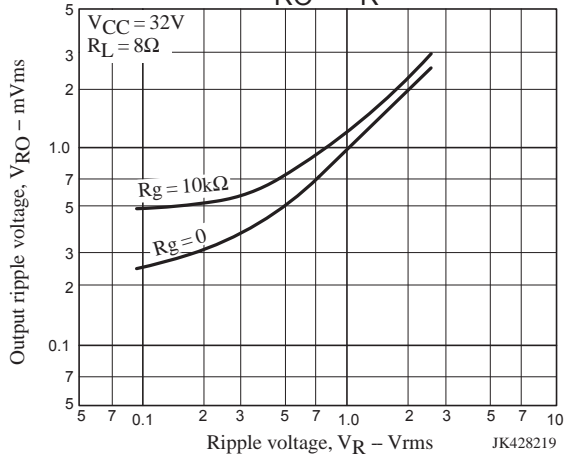
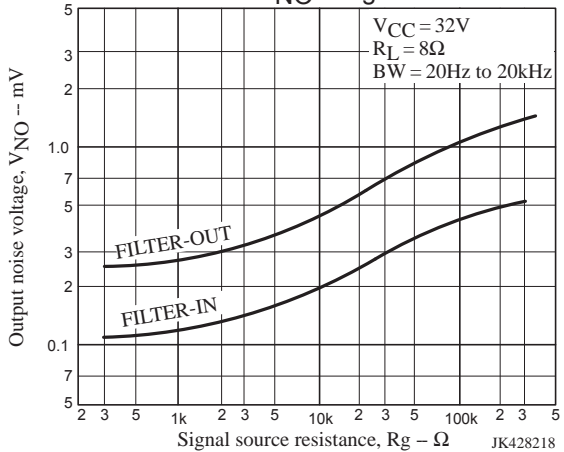
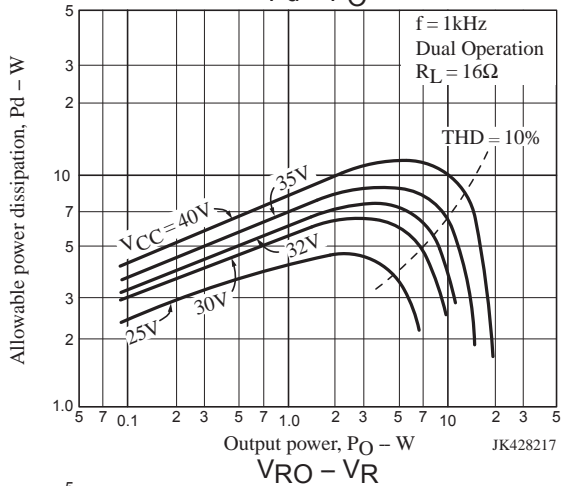
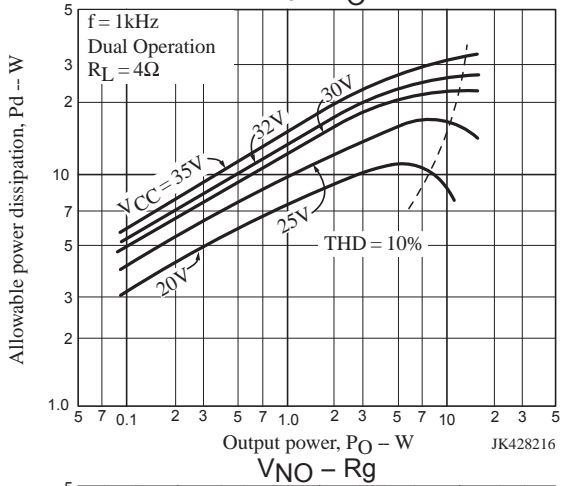
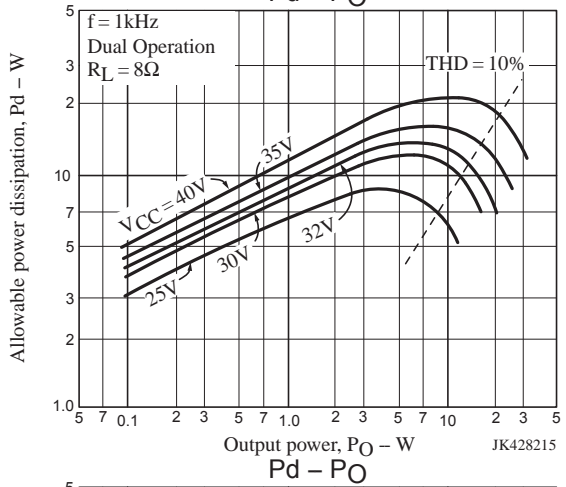
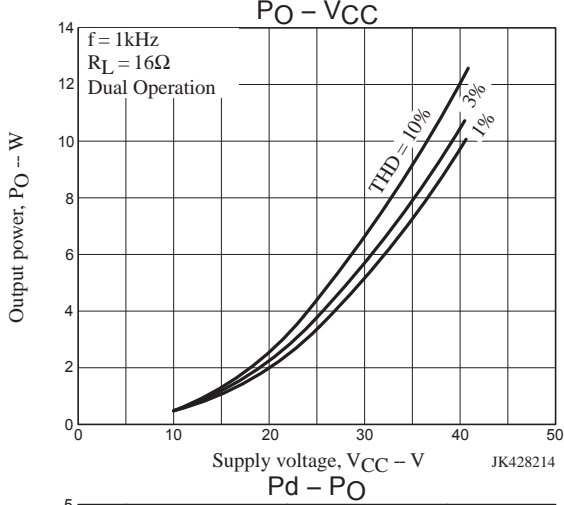
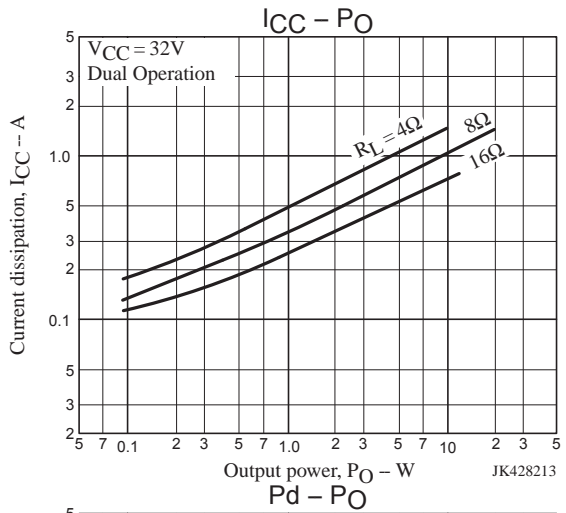
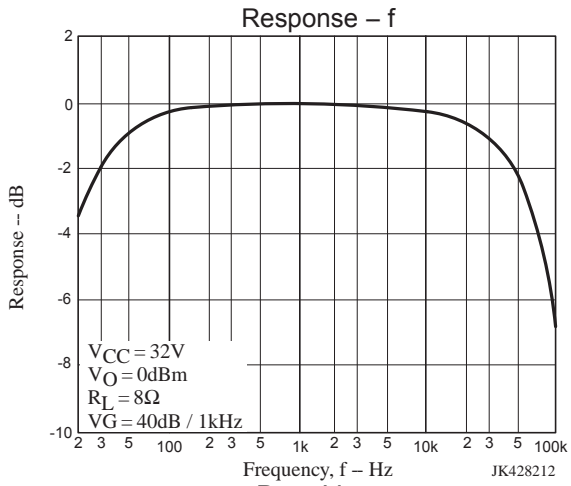

LA4282

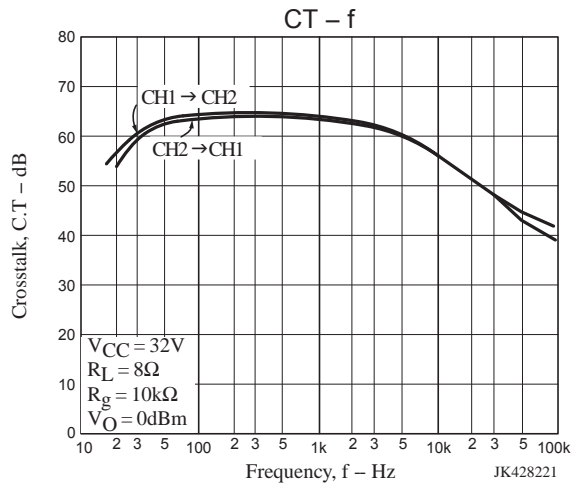
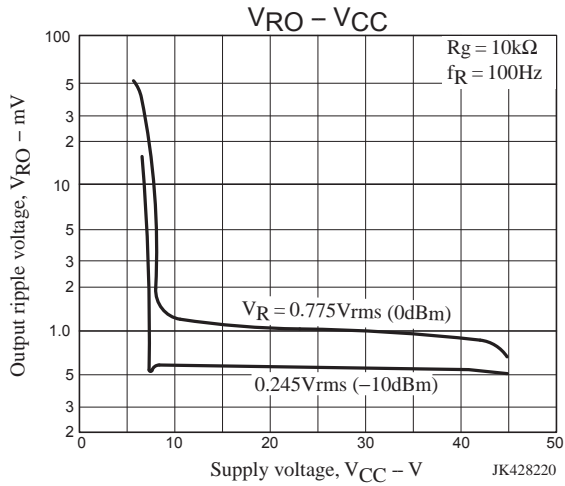

ON Semiconductor and the ON logo are registered trademarks of Semiconductor Components Industries, LLC (SCILLC) or its subsidiaries in the United States and/or other countries. SCILLC owns the rights to a number of patents, trademarks, copyrights, trade secrets, and other intellectual property. A listing of SCILLC's product/patent coverage may be accessed at www.onsemi.com/site/pdf/Patent-Marking.pdf. SCILLC reserves the right to make changes without further notice to any products herein. SCILLC makes no warranty, representation or guarantee regarding the suitability of its products for any particular purpose, nor does SCILLC assume any liability arising out of the application or use of any product or circuit, and specifically disclaims any and all liability, including without limitation special, consequential or incidental damages. "Typical" parameters which may be provided in SCILLC data sheets and/or specifications can and do vary in different applications and actual performance may vary over time. All operating parameters, including "Typicals" must be validated for each customer application by customer's technical experts. SCILLC does not convey any license under its patent rights nor the rights of others. SCILLC products are not designed, intended, or authorized for use as components in systems intended for surgical implant into the body, or other applications intended to support or sustain life, or for any other application in which the failure of the SCILLC product could create a situation where personal injury or death may occur. Should Buyer purchase or use SCILLC products for any such unintended or unauthorized application, Buyer shall indemnify and hold SCILLC and its officers, employees, subsidiaries, affiliates, and distributors harmless against all claims, costs, damages, and expenses, and reasonable attorney fees arising out of, directly or indirectly, any claim of personal injury or death associated with such unintended or unauthorized use, even if such claim alleges that SCILLC was negligent regarding the design or manufacture of the part. SCILLC is an Equal Opportunity/Affirmative Action Employer. This literature is subject to all applicable copyright laws and is not for resale in any manner.