

TYPE: \_\_\_\_\_ QUANTITY: \_\_\_\_\_ PROJECT: \_\_\_\_\_

CATALOG NUMBER:

FIXTURE    WATTAGE    VOLTAGE    FINISH    OPTION    OPTION    OPTION    OPTION

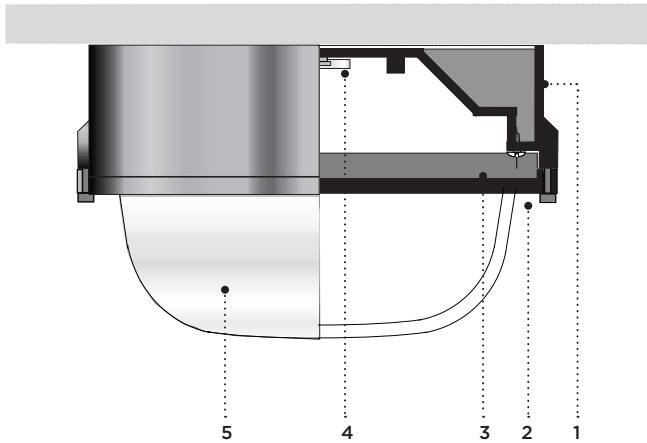

- 1- Cast aluminum enclosed driver housing.
- 2- Cast aluminum lens ring.
- 3- Silicone gasket with memory retention.
- 4- Heat dissipating fins with removable LED platform.
- 5- Borosilicate frosted glass diffuser with internal concentric prismatic pattern.

All stainless steel hardware.

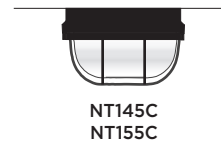

NT145C



NT155C



### MATERIALS

Nautilux is made of corrosion resistant 356 aluminum alloy with a copper (CU) content of less than 0.1%. LED platform is easily removable and secured with a heat dissipating plate for optimal light performance. LED light engine is installed in down lighting position to provide a general diffused light over the glass diffuser.

### ELECTRICAL

#### LED

**DRIVER** Standard driver is 0-10V dimming-ready (dims to 10%) with: 120-277 multi-volt compatibility (50-60Hz), minimum operating temperature of -30°C/-22°F, output over voltage protection, output over current protection, output short circuit protection with auto-recovery, and over temperature protection (110°C).

**LED** Standard 4000K LED platform included. Optional 3000K and 3500K available. Removable modular LED platform.

### LIFE

51,000hrs  $L_{77}B_{50}$  (based on IESNA TM-21 Test Method and LM-80 data).  
68,000hrs  $L_{70}B_{50}$  (calculated projection from LM-80 data).

### FINISH

Five-stage preparation process includes preheating of cast aluminum parts for air extraction. Polyester powder coating is applied through an electrostatic process, and oven cured for long term finish.

### MOUNTING

Maximum weight: 10lbs (4.5kg)  
Nautilux is designed as a ceiling mount luminaire. Mounts over a standard 4" (102) octagonal electrical box with 3 1/2" (89) C/C mounting holes.

### CERTIFICATION

Tested to UL1598 and CSA 22.2 #250. ETL listed wet location. Photometry tested per IES LM-79-08 / IES LM80 test report. Rated IP65.

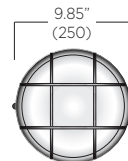

**NT145C**  
Frosted diffuser  
with cast aluminum  
cross cage



**NT155C**  
Frosted diffuser

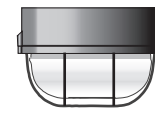

**NT145C**  
6.5" (165)  
**NT155C**  
6" (152)

# NT145C/NT155C SERIES NAUTILUX - LED

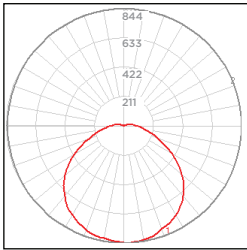

## TYPICAL PHOTOMETRY SUMMARY



**Descriptive Information**  
 NT145C-L1W30r1  
 Total Lms: 2748 Lumens  
 Total Input Watts: 33.26 W  
 Source: LED  
 Efficacy: 82.62 Lumens/Watt  
 BUG: B1-U3-G1  
 CCT/CRI: 4000K/80  
 Maximum Candela: 844 @ 2.5 deg V

Please visit our web site [www.luminis.com](http://www.luminis.com) for complete I.E.S. formatted download data.

## LUMINAIRE SELECTION

| MODEL#  | LED LIGHT SELECTION            |                    |                         |            |              | VOLTAGE <sup>1</sup>   | FINISH   |
|---|--------------------------------|--------------------|-------------------------|------------|--------------|--|--|
| <br><input type="checkbox"/> NT145C  | <b>SUFFIX</b>                  | <b>INPUT WATTS</b> | <b>DELIVERED LUMENS</b> | <b>CRI</b> | <b>CCT K</b> | <input type="checkbox"/> 120V<br><input type="checkbox"/> 277V | <b>STANDARD COLORS</b><br><input type="checkbox"/> WHT Snow white<br><input type="checkbox"/> BKT Jet black<br><input type="checkbox"/> BZT Bronze<br><input type="checkbox"/> MST Matte silver<br><input type="checkbox"/> GRT Titanium gray<br><input type="checkbox"/> DGT Gun metal<br><input type="checkbox"/> CHT Champagne<br><br><b>OPTIONAL COLORS</b><br><input type="checkbox"/> CS Custom color<br><input type="checkbox"/> RAL RAL# color<br>(Refer to color chart) |
|   | <input type="checkbox"/> L1W12 | 13W                | 1131                    |            |              |  |  |
|   | <input type="checkbox"/> L1W18 | 23W                | 1935                    | 80         | 4000K        |  |  |
|   | <input type="checkbox"/> L1W30 | 33W                | 2748                    |            |              |  |  |
| <br><input type="checkbox"/> NT155C |                                |                    |                         |            |              |  |  |

## OPTIONS

### ELECTRICAL

- FS** Fuse<sup>2</sup>
- PH** Photocell<sup>2</sup>

Alternate CCT K LED

- K3** 3000K CCT LED
- K35** 3500K CCT LED

### ACCESSORIES

- SWK** Surface mount connection box  
(Single luminaire connection. 1" extension)

### NOTES

- 1- If no voltage is specified, luminaires are factory prewired by default for 120V. For other voltages, please specify with catalog number, or consult factory.
- 2- Fuse and photocell options are normally installed with poles when specified with Luminis luminaires (except for other mounting types).

**LUMINIS**<sup>®</sup>

LUMINIS | Toll free: 866.586.4647 Fax: 514.683.8872  
 260 Labrosse, Pointe-Claire (QC) Canada H9R 5L5

LUMINIS.COM

Luminaires may be altered for design improvement or discontinued without prior notice.

Jan 2018 Rev 0