

SPECIFICATION

Part No. : LMA101.A.BI.001

Product Name : Gemini 2*LTE 4G MIMO Magnetic Antenna

Features : Best solution for 2*LTE MIMO Worldwide applications
 Covers Fallback 3G/2G Frequencies
 (HSPA/UMTS/WCDMA/GSM/GPRS)
 698-960MHz, 1710-2170MHz, 2490-2690MHz
 High Efficiency Indoor and Outdoor Antenna
 IP67 Rating
 3 Way Base Mount for Implementation

- Magnetic Mount
- Wall Mount
- Desktop Mount

 Dims: 164*164*36.5mm
 2*Low Loss 1M CFD-200 Cables, SMA(M)
 Cable and Connector Customizable
RoHS Compliant

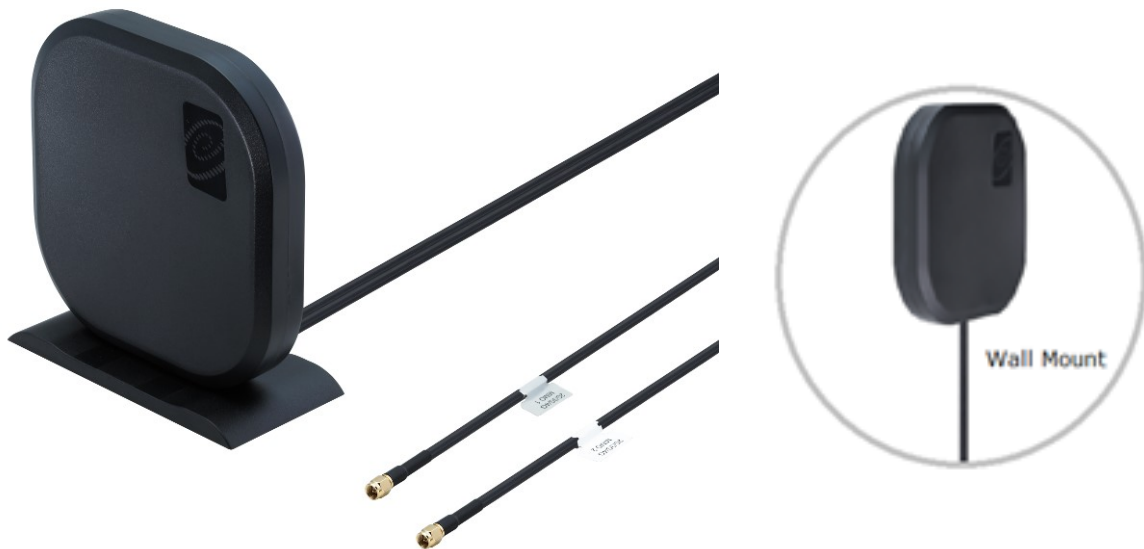

1. Introduction

The Gemini LMA101 features eight embedded super-magnets for easy and robust installation on metal surfaces.

This 2*2 LTE 4G MIMO is a robust external antenna that is fully IP67 waterproof for use with all 4G/3G/2G MIMO cellular routers and access points worldwide. It includes two embedded high efficiency LTE MIMO antennas. The antenna elements operate at all common and 4G LTE bands worldwide; 698-960MHz, 1710-2170MHz, 2490-2690MHz, which also include the 3G and 2G bands, meaning the antenna can also be used as fallback on 2G or 3G applications. High isolation and low ECC between the two embedded MIMO antennas prevents self-interference. Low loss cables are used to keep efficiency high over long cable lengths up to 5 meters.

This unique antenna offers three methods for easy installation. A bracket on the back of the antenna enables easy wall installation, keeping your work station free from clutter. The antenna can also be placed directly on a flat surface using the stand holder or mounted magnetically using eight super magnets for secure and permanent base mounting.

Typical Applications

- HD Real-time Streaming Video over LTE
- Intelligent Transport Systems
- Internet of Things (IoT market)
- Digital Signage
- HD Broadcast Systems
- Wireless 4G LTE MIMO M2M devices with legacy 3G Functionality.

Cable length and connector types are customizable. Contact your regional Taoglas sales office for support.

2. Specification Table

4G/3G/2G Antenna								
Frequency (MHz)	LTE700	GSM850	GSM900	DCS	PCS	UMTS1	LTE 2600	
	698~824	824~894	880~960	1710~1880	1850~1990	1920~2170	2490~2690	
Efficiency (%)								
MIMO1	0.3M	77.91	57.40	46.79	66.09	61.53	43.94	41.33
	1M	74.40	54.82	44.68	60.27	56.20	40.36	37.70
	2M	66.31	48.59	38.91	49.44	45.76	32.97	29.63
	3M	61.89	45.06	36.11	43.76	40.32	28.84	25.17
	5M	53.13	37.96	30.30	34.20	31.13	22.32	19.24
MIMO2	0.3M	73.17	46.21	37.12	71.80	59.28	45.79	45.25
	1M	69.88	44.13	35.45	65.48	54.17	42.14	41.27
	2M	62.28	39.09	30.87	53.75	44.11	34.45	32.49
	3M	58.12	36.23	28.63	47.54	38.89	30.14	27.63
	5M	49.90	30.55	24.07	37.19	30.01	23.33	21.11
Average Gain (dBi)								
MIMO1	0.3M	-1.12	-2.46	-3.32	-1.83	-2.20	-3.82	-3.92
	1M	-1.32	-2.66	-3.52	-2.23	-2.59	-4.18	-4.32
	2M	-1.82	-3.18	-4.12	-3.09	-3.48	-5.06	-5.36
	3M	-2.12	-3.51	-4.45	-3.62	-4.04	-5.64	-6.07
	5M	-2.79	-4.26	-5.20	-4.69	-5.16	-6.75	-7.23
MIMO2	0.3M	-1.42	-3.36	-4.35	-1.45	-2.37	-3.55	-3.48
	1M	-1.62	-3.56	-4.55	-1.85	-2.76	-3.91	-3.88
	2M	-2.12	-4.09	-5.15	-2.71	-3.65	-4.78	-4.92
	3M	-2.42	-4.42	-5.48	-3.24	-4.21	-5.37	-5.63
	5M	-3.08	-5.16	-6.23	-4.31	-5.33	-6.47	-6.80
Peak Gain (dBi)								
MIMO1	0.3M	4.76	3.42	3.07	4.68	4.68	4.20	2.41
	1M	4.56	3.22	2.87	4.28	4.28	3.80	2.01
	2M	4.06	2.72	2.27	3.38	3.38	2.90	1.01
	3M	3.76	2.42	1.97	2.88	2.88	2.30	0.31
	5M	3.16	1.62	1.17	1.78	1.78	1.20	-0.89
MIMO2	0.3M	4.62	2.94	2.89	5.04	5.12	5.08	2.20
	1M	4.42	2.74	2.69	4.64	4.72	4.68	1.80
	2M	3.92	2.24	2.09	3.74	3.82	3.78	0.80
	3M	3.62	1.84	1.79	3.24	3.32	3.28	0.10
	5M	3.02	1.14	1.09	2.14	3.32	2.08	-1.00
Impedance		50Ω						
Polarization		Vertical						

MECHANICAL	
Casing	PCL1250Y
Coaxial Cable	CFD-200
Cable Length	1 Meter Standard, fully customizable
Connector	SMA Male Standard, fully customizable
Weight	400g (Antenna with 1 meter Cable and Stand)
Dimension	164*164*36.5mm
Waterproof Rating	IP67
Magnetic Pull Force	11.24 kgF-cm
Magnetic Dim/Pcs	Φ18*3t N48M/ 8 pcs
ENVIRONMENTAL	
Operation Temperature	-40°C to 85°C
Storage Temperature	-40°C to 85°C
Humidity	Non-condensing 65°C 95% RH

3. Antenna Characteristics

3.1. Return Loss

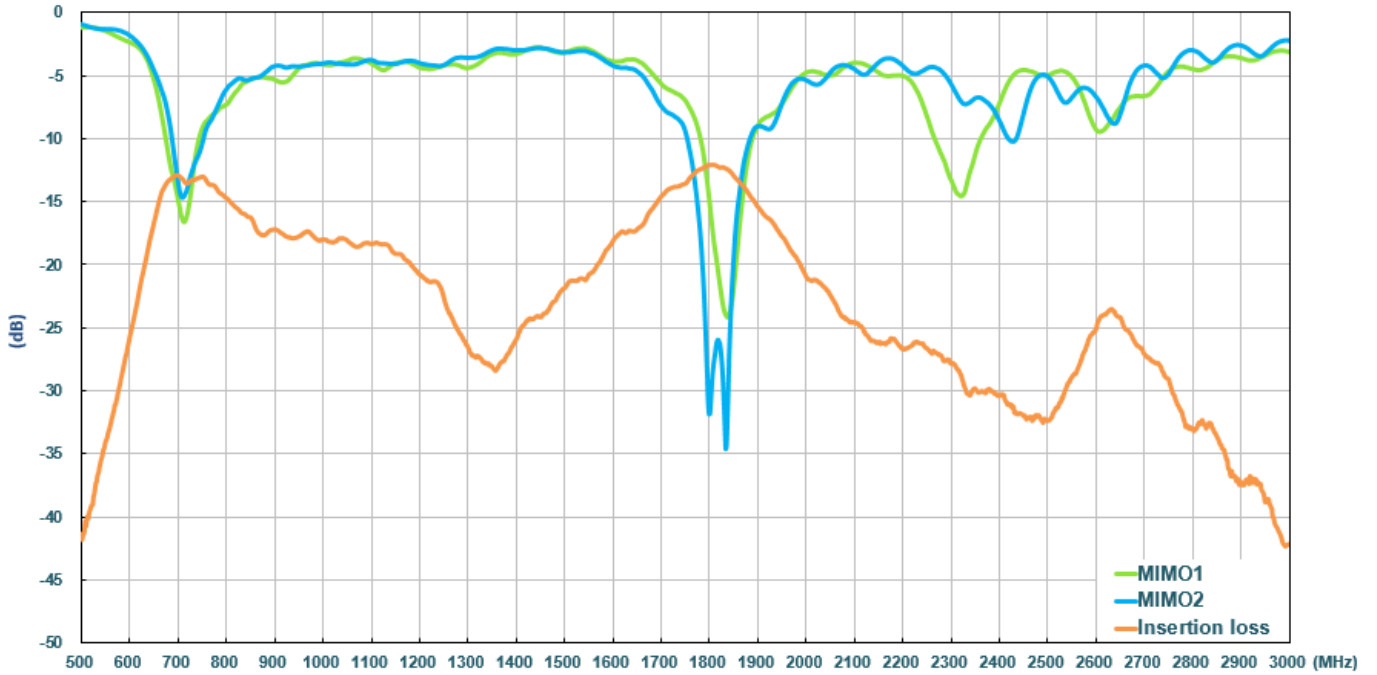

3.2. Efficiency

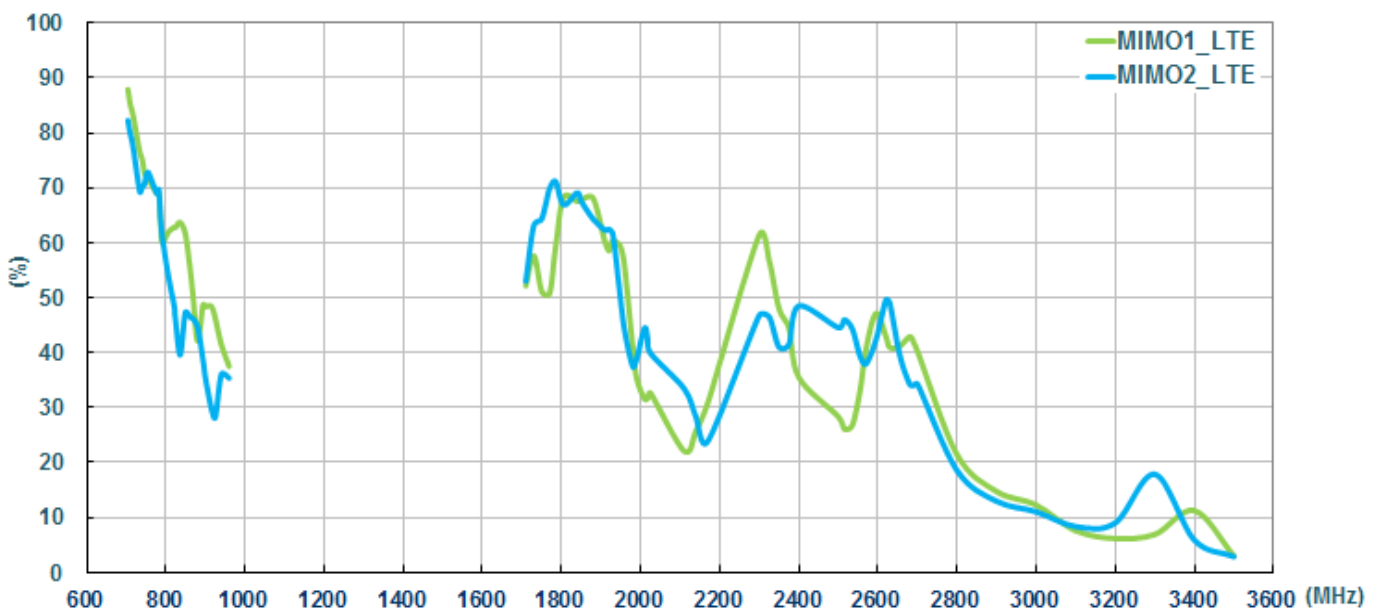

3.3. Average Gain

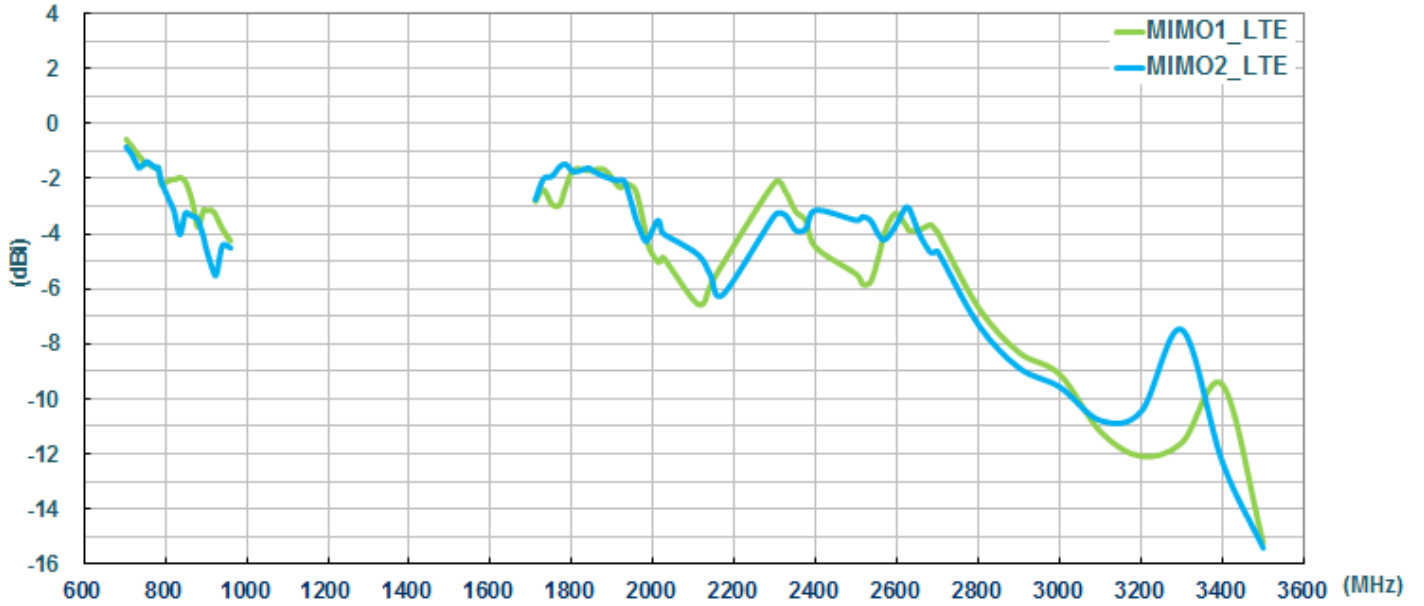

3.4. Peak Gain

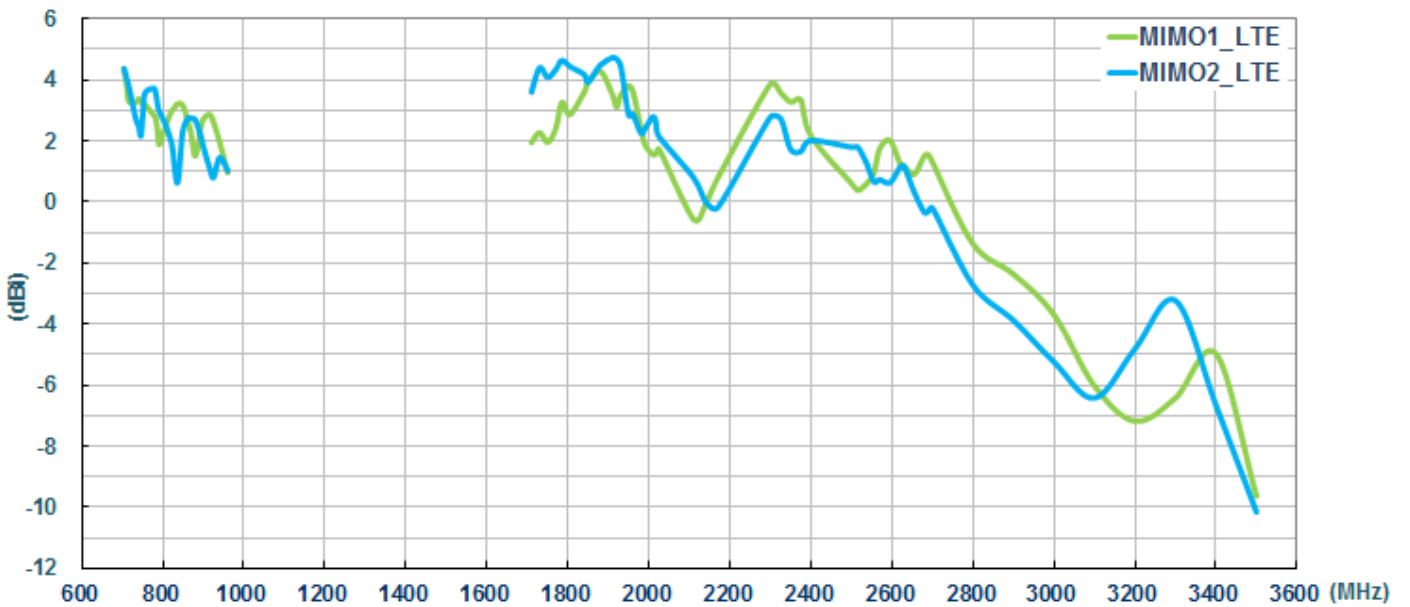

4. Radiation Patterns

4.1. Test Setup

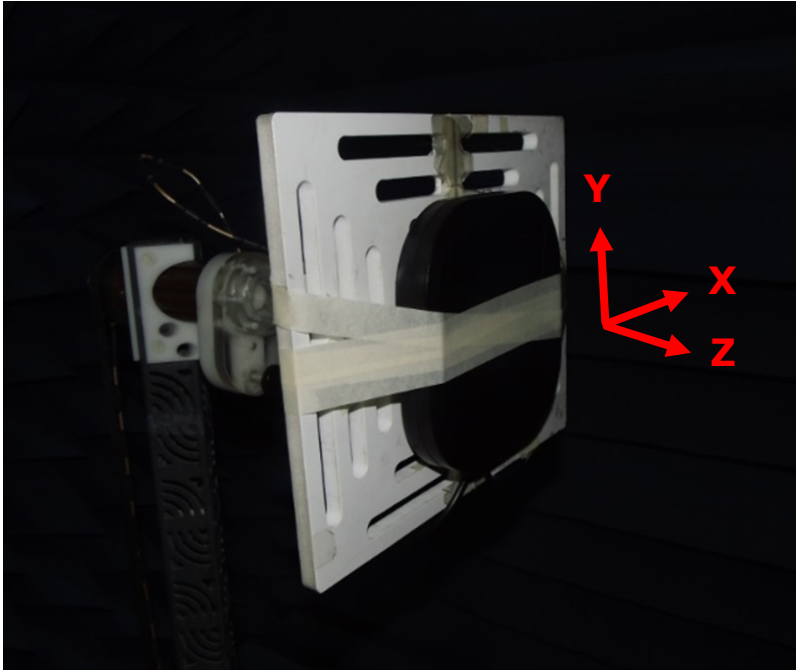

4.2. LTE MIMO1 (2D Radiation Pattern)

XY Plane

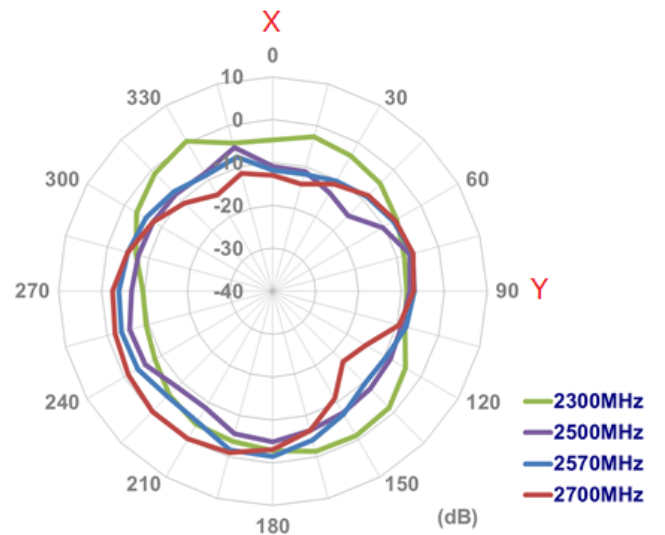
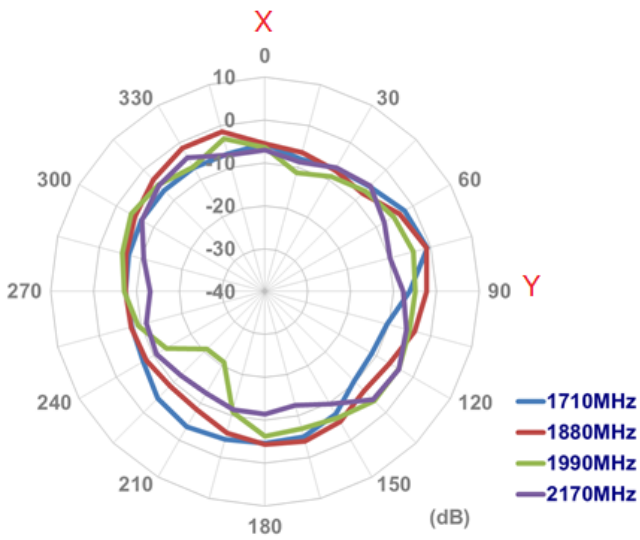
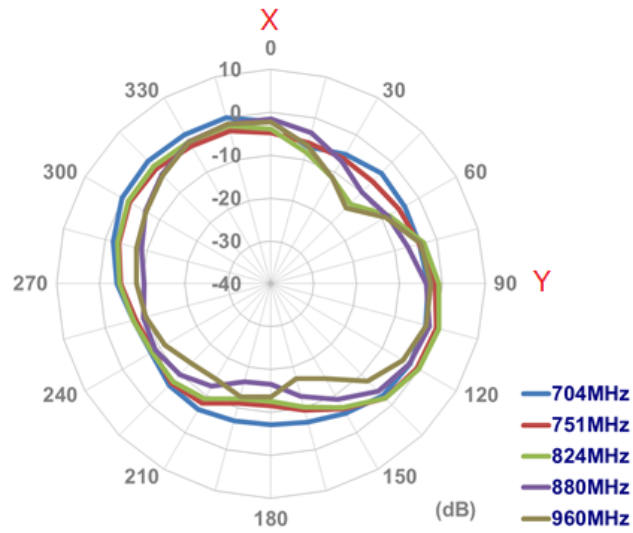

XZ Plane

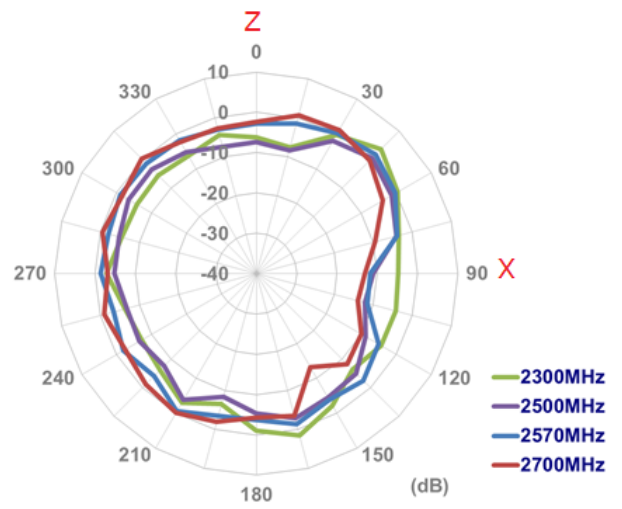
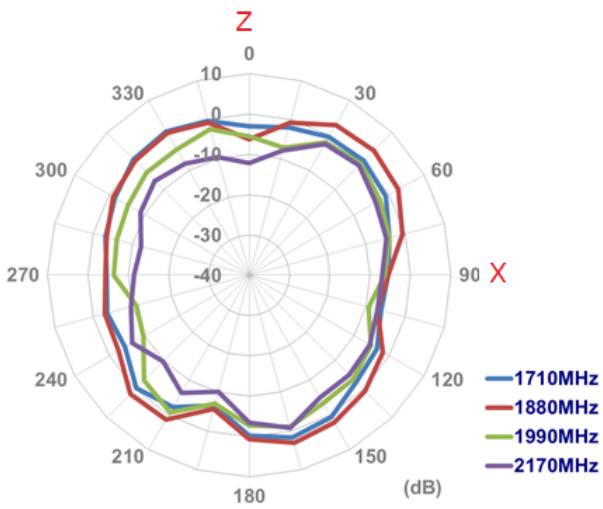
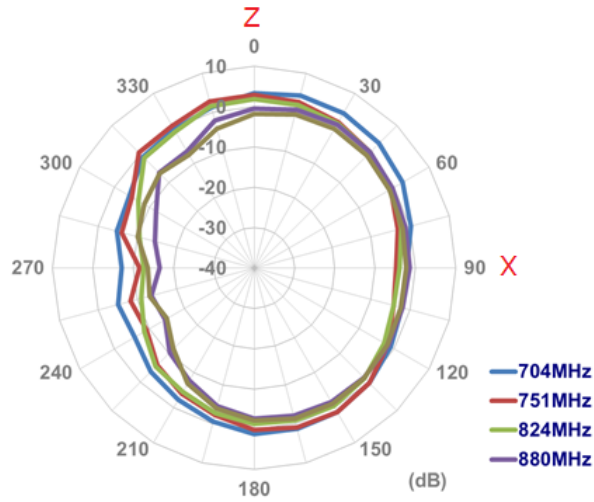

YZ Plane

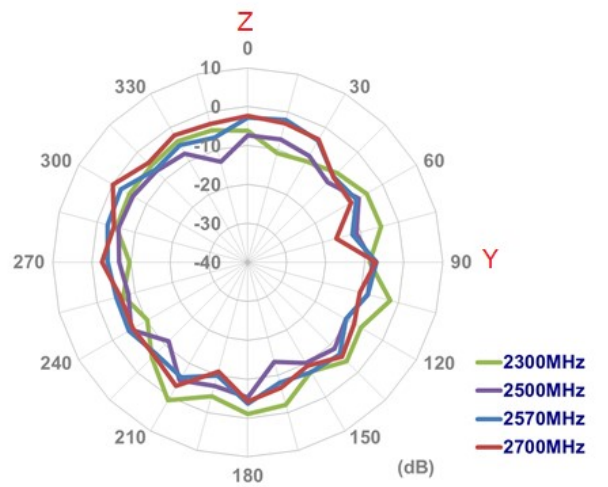
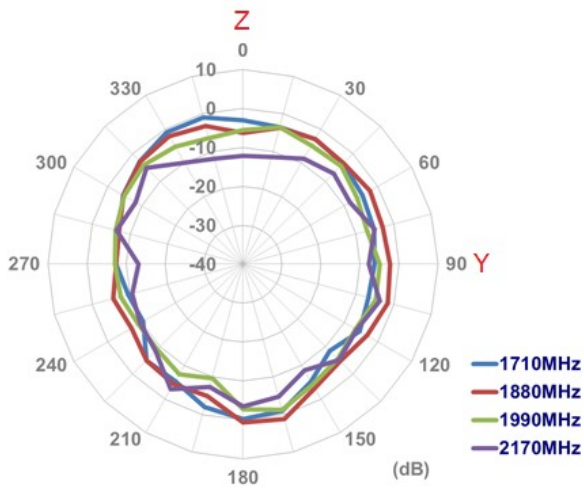
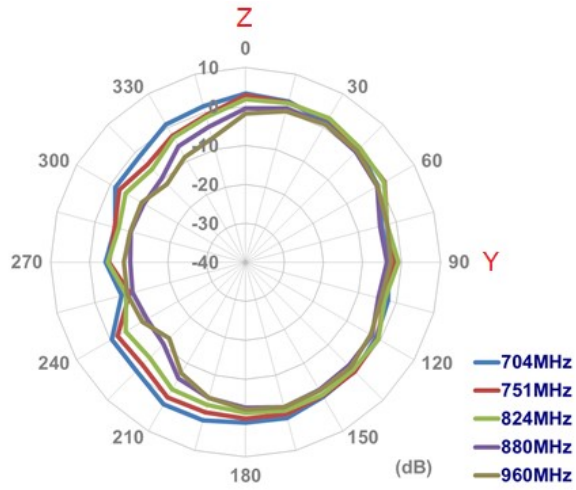

4.3. LTE MIMO 1 (3D Radiation Pattern)

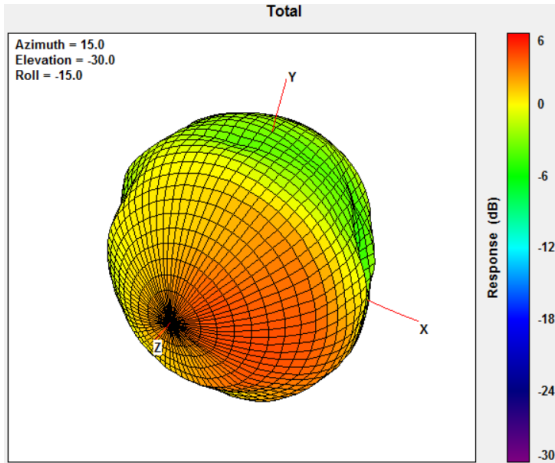

704MHz

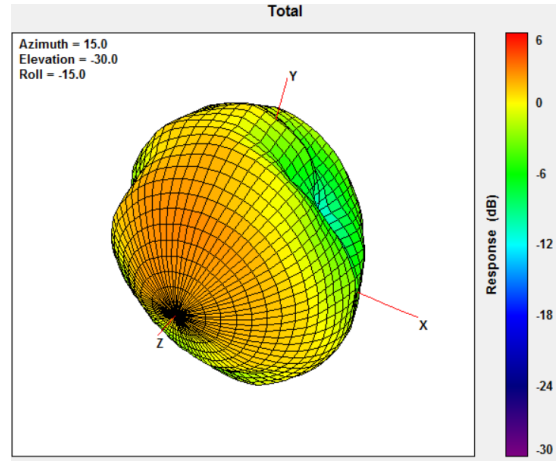

824MHz

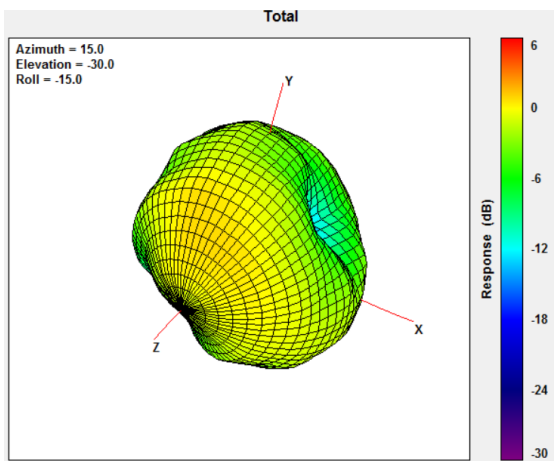

960MHz

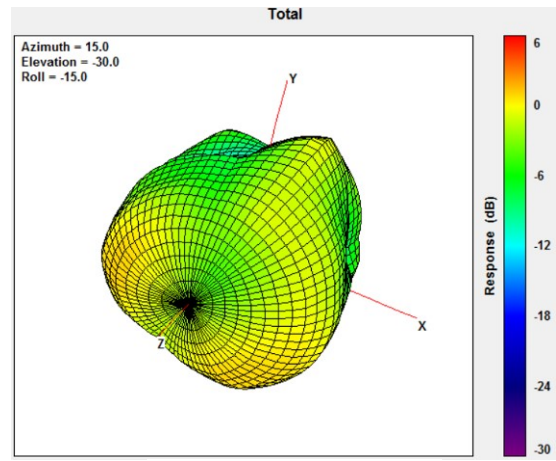

1710MHz

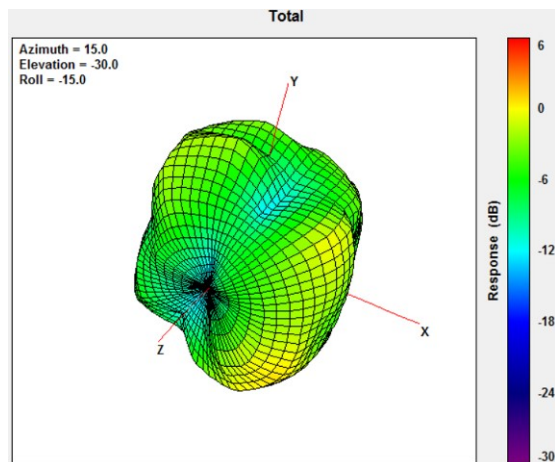

2170MHz

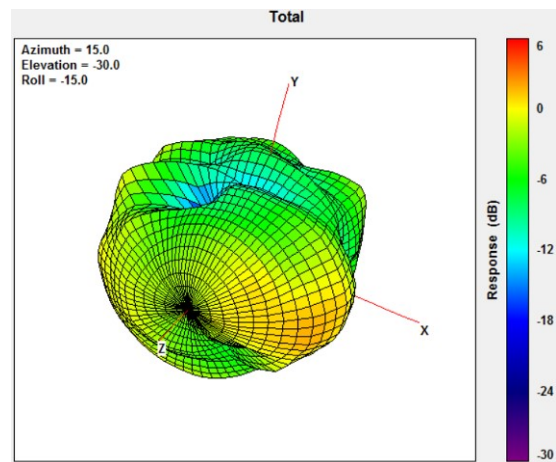

2600MHz

4.4. LTE MIMO2 (2D Radiation Pattern)

XY Plane

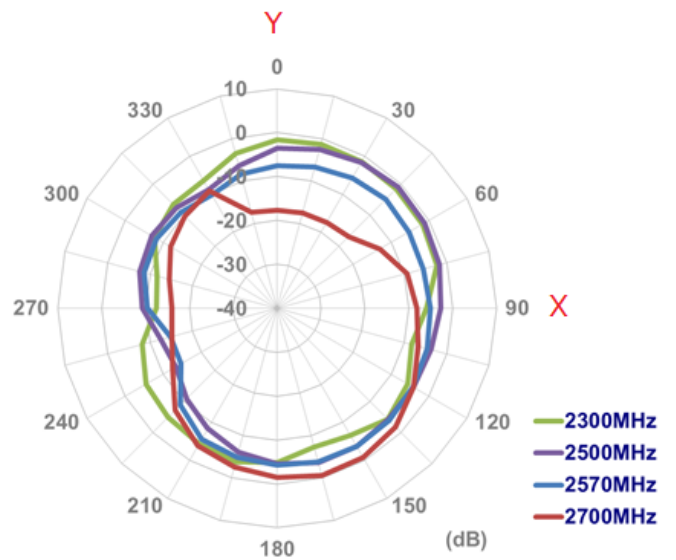
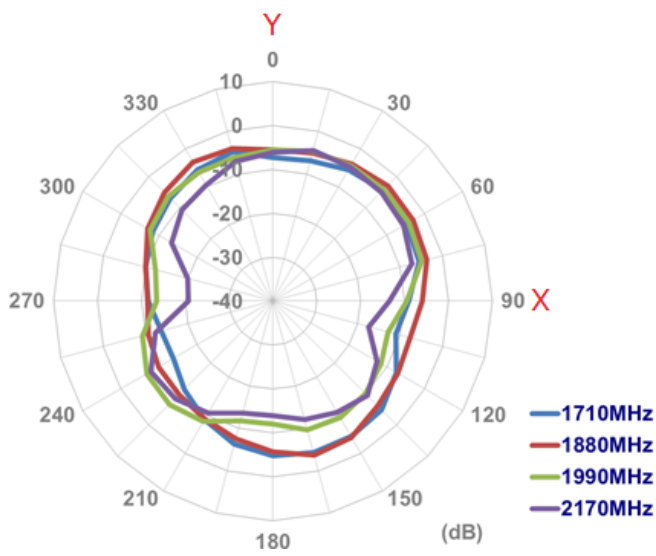
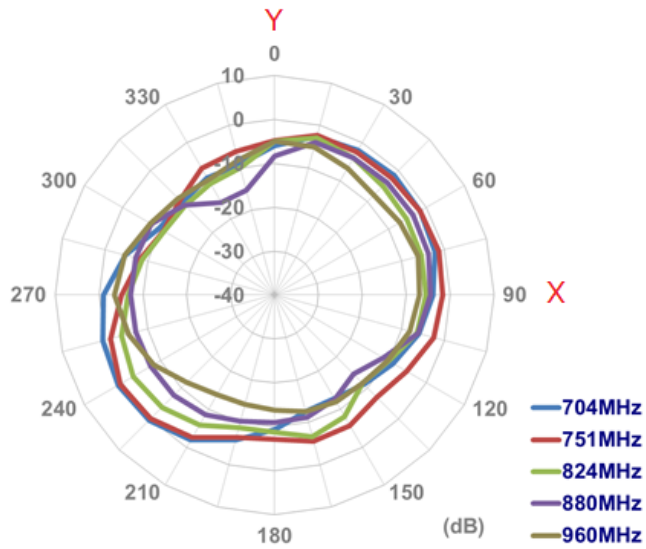

XZ Plane

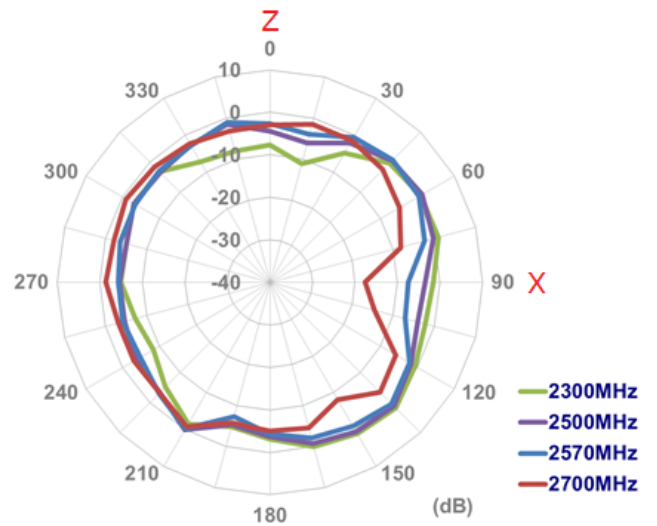
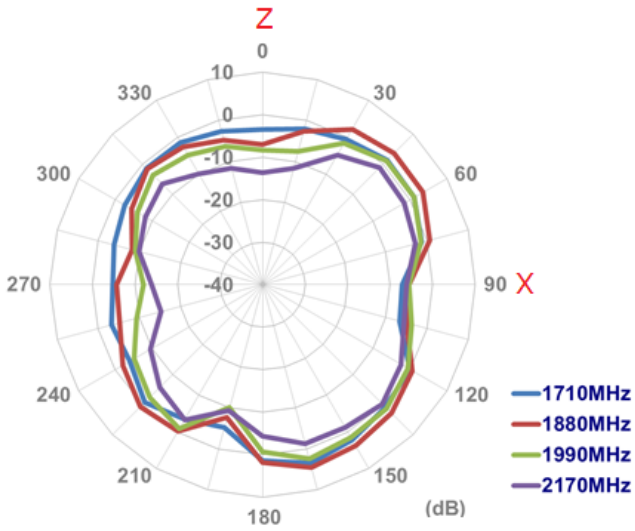
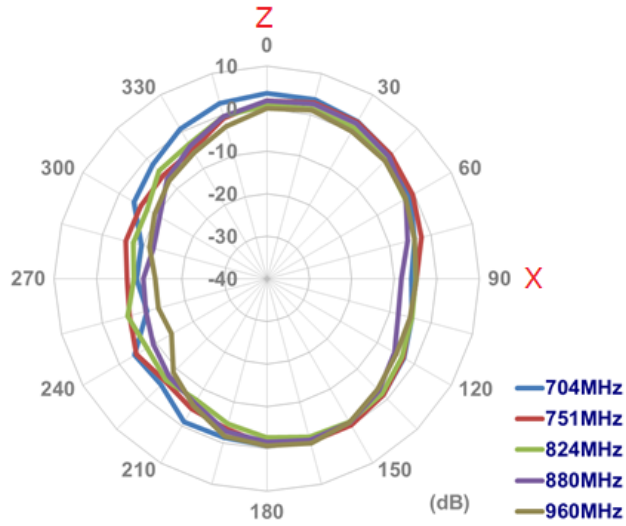

YZ Plane

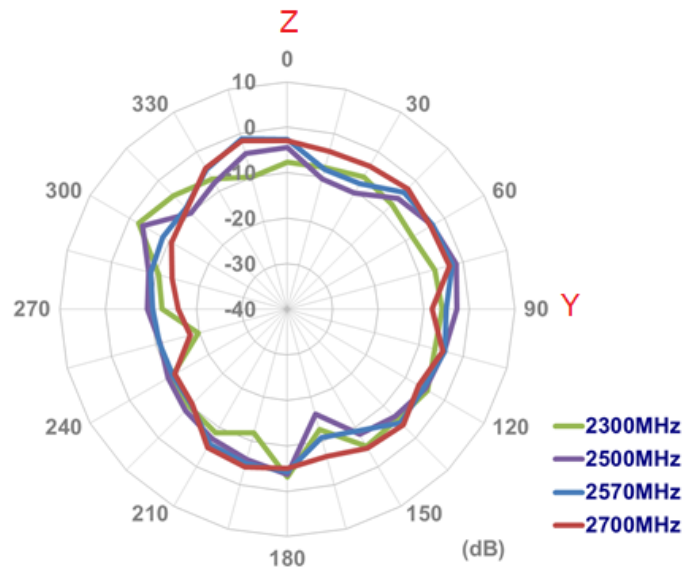
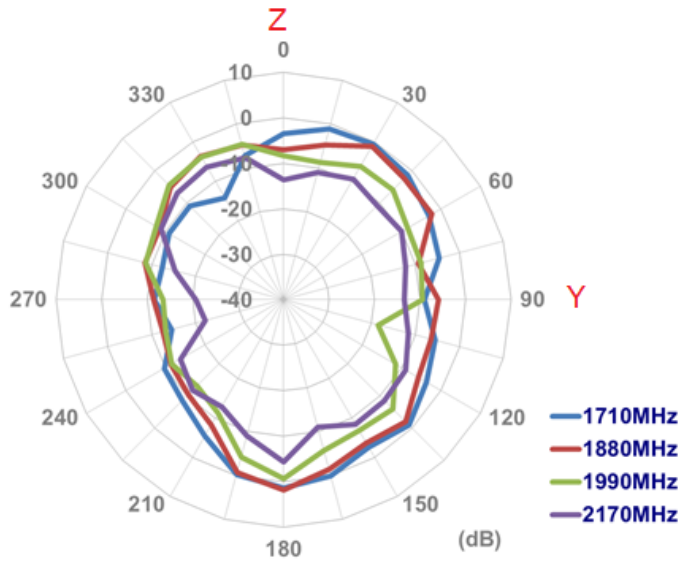
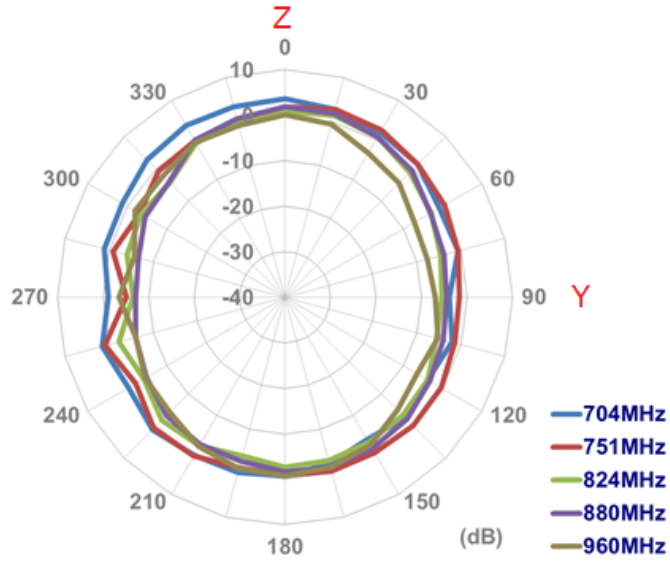

4.5. LTE MIMO 2 (3D Radiation Pattern)

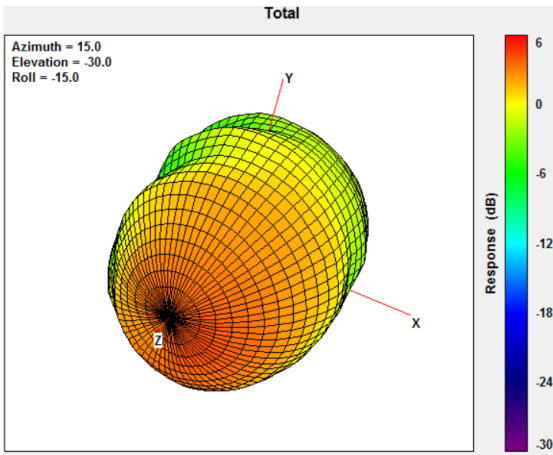

704MHz

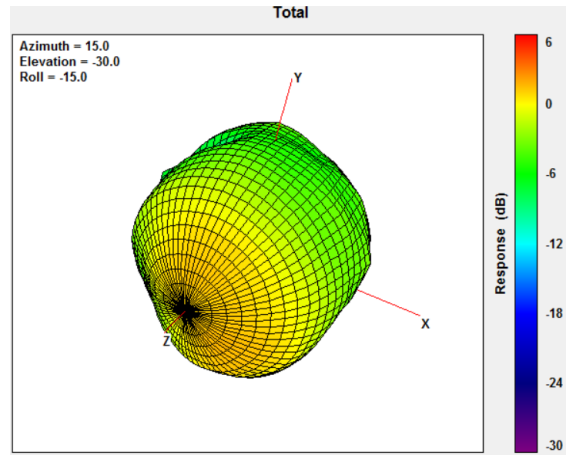

824MHz

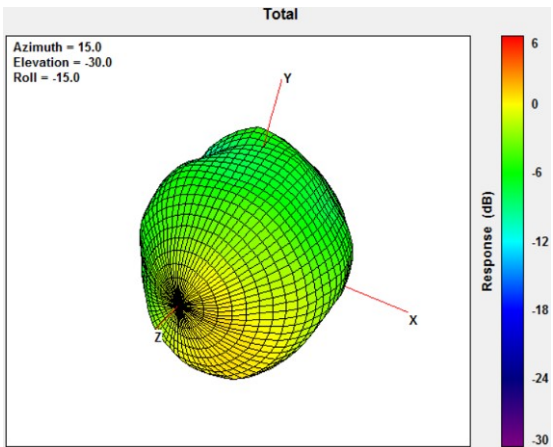

960MHz

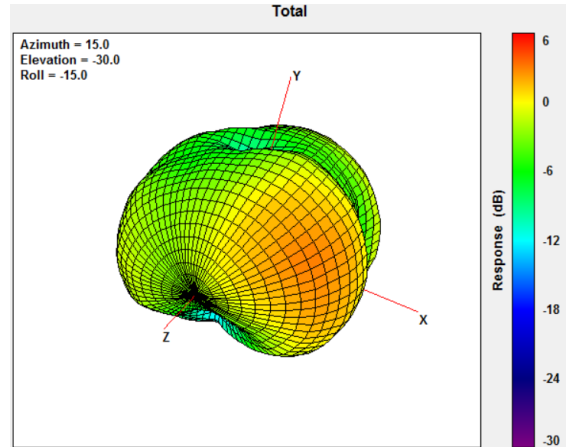

1710MHz

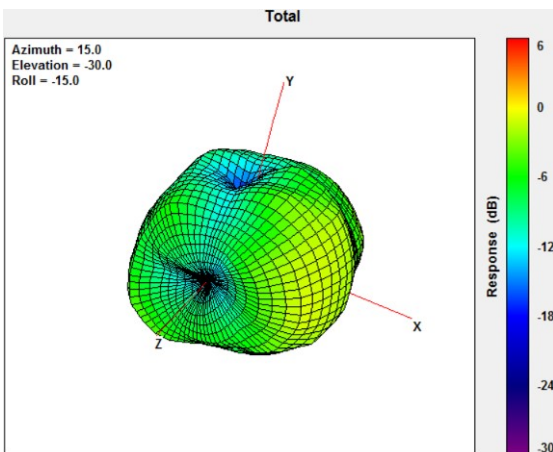

2170MHz

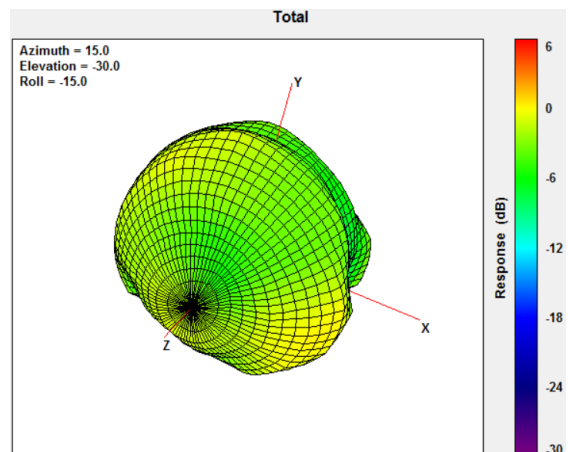

2600MHz

5. Mechanical Drawing

Mounting Type
Wall

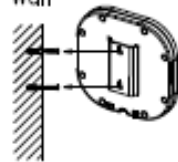

Stand

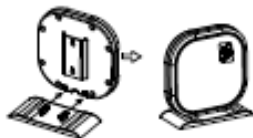

Package:

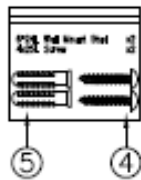

Antenna Individual Box (Brown)
1pcs in 1 Box

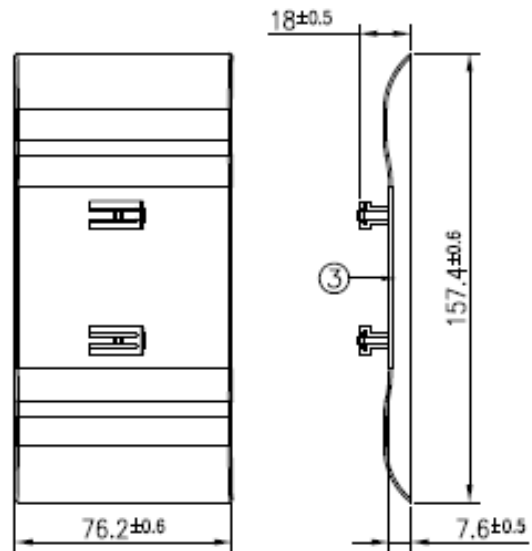
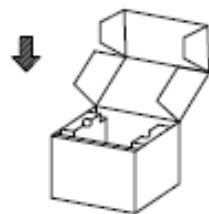

Back View

Side View

① Front View

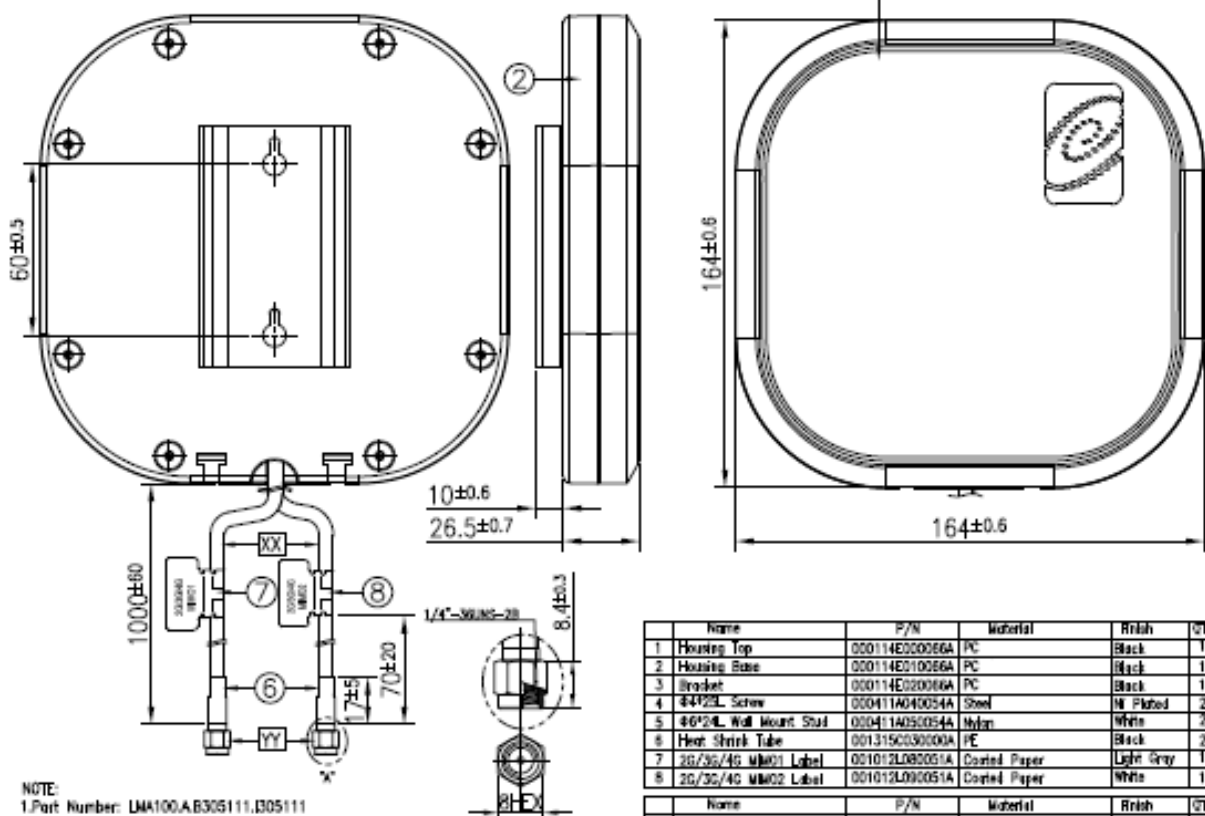

NOTE:
1.Part Number: LMA100.A.B305111,B05111

Name	P/N	Material	Finish	QTY
1 Housing Top	000114E000066A	PC	Black	1
2 Housing Base	000114E010066A	PC	Black	1
3 Bracket	000114E000066A	PC	Black	1
4 #4V2L Screw	000411A040054A	Steel	Ni Plated	2
5 #6V2L Wall Mount Stud	000411A050054A	Nylon	White	2
6 Heat Shrink Tube	001315C030000A	PE	Black	2
7 26/35/46 MM01 Label	001012L000051A	Coated Paper	Light Gray	1
8 26/35/46 MM02 Label	001012L000051A	Coated Paper	White	1
Name	P/N	Material	Finish	QTY
XX Cable Type	301415C010000A	FR0200	Black	2
YY Connector Type	200212K010000A	SWNM/ST	Au Plated	2

6. Packaging

LMA101.A.BI.001

Packaging Specifications

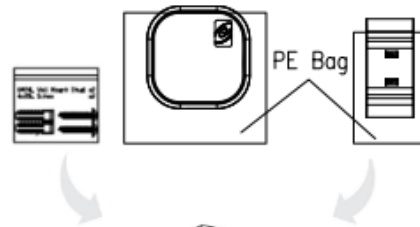

1pc LMA101.A.BI.001 per small box
 Box Dimensions - 235*170*110mm
 Weight - 650g

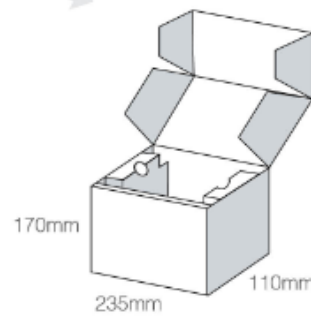

5 small boxes in one carton
 Carton Dimensions - 360*290*260mm
 Weight - 3.8Kg

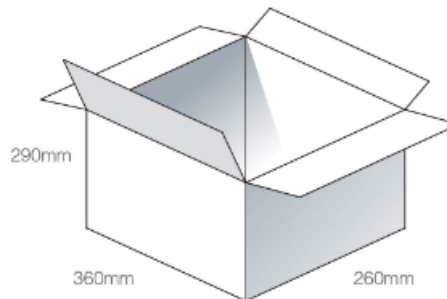

Pallet Dimensions 1100*1100*1290mm
 48 Cartons per Pallet
 12 Cartons per layer
 4 Layers

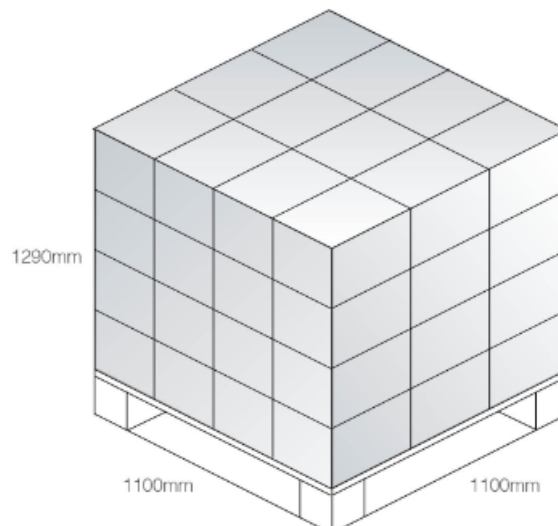

7. Installation Instructions

7.1. Package Contents

6*24L
Wall Mount
Stud *2

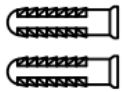

4*25L
Screw*2



Stand *1

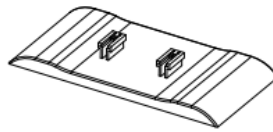

Antenna *1

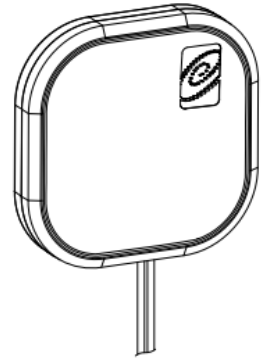

7.2. Desktop Stand/Magnet Mount Installation

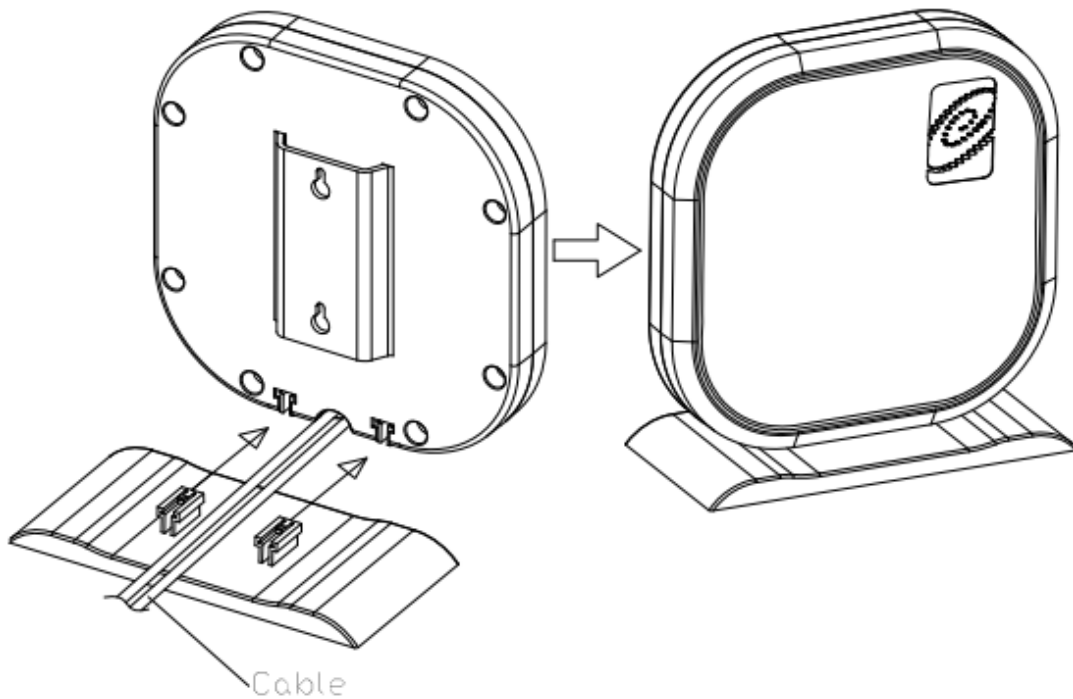

7.3. Wall Mount Installation

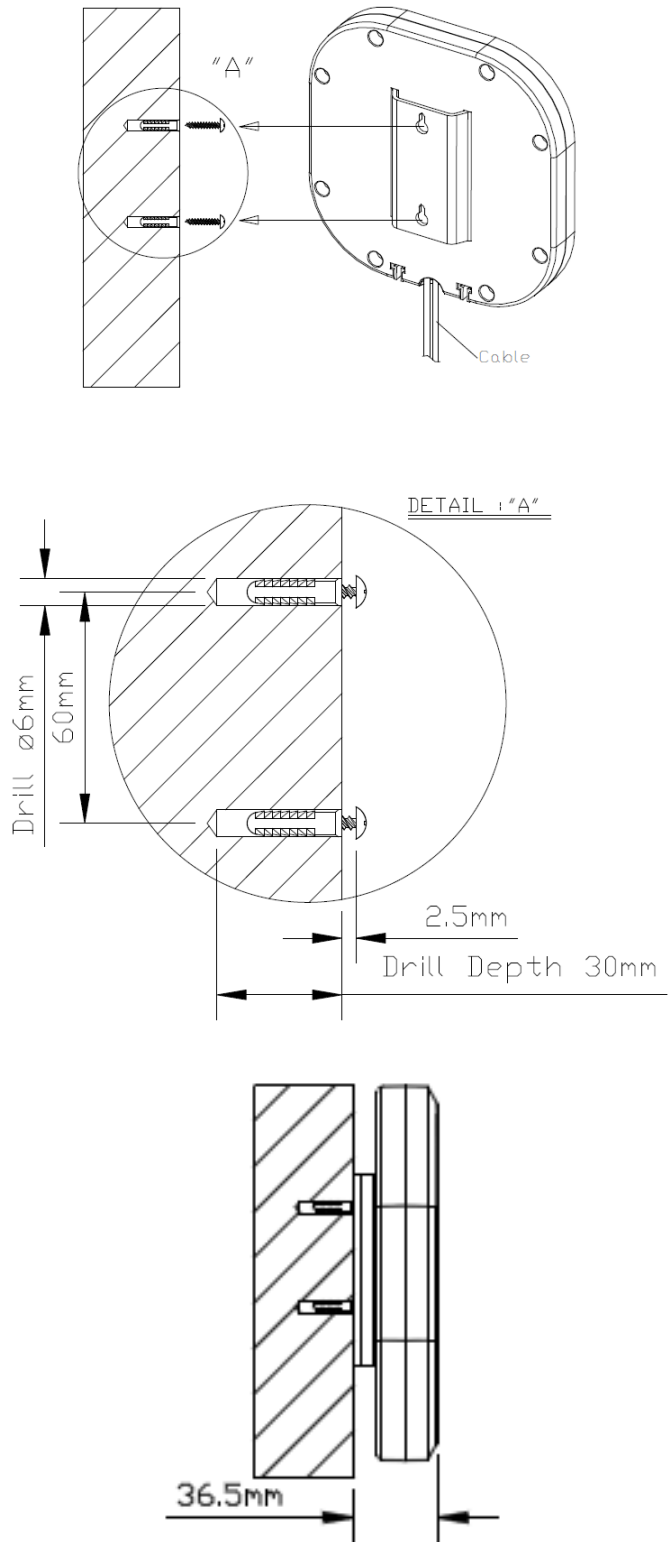

8. Magnetic Pull Force

8.1. Testing setup

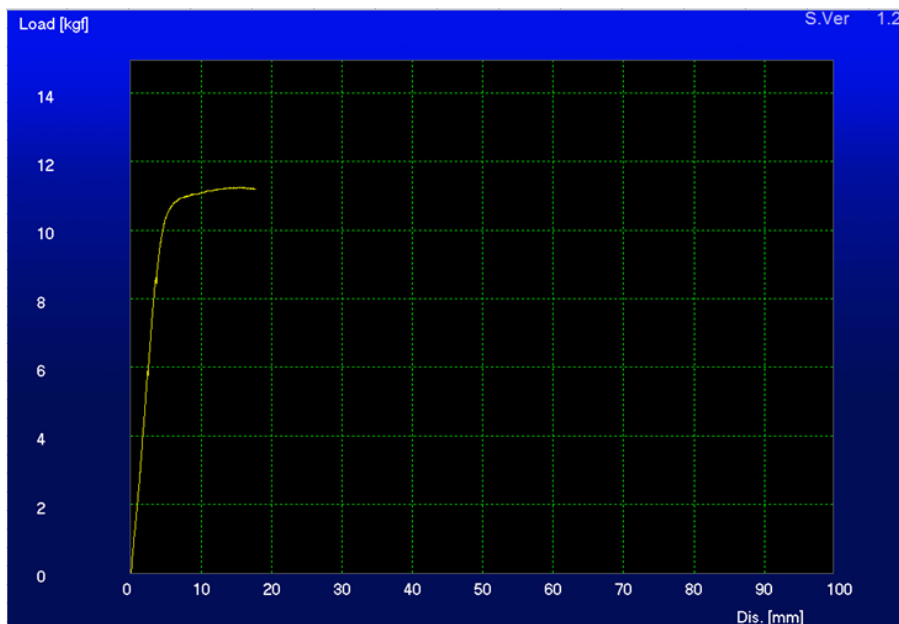
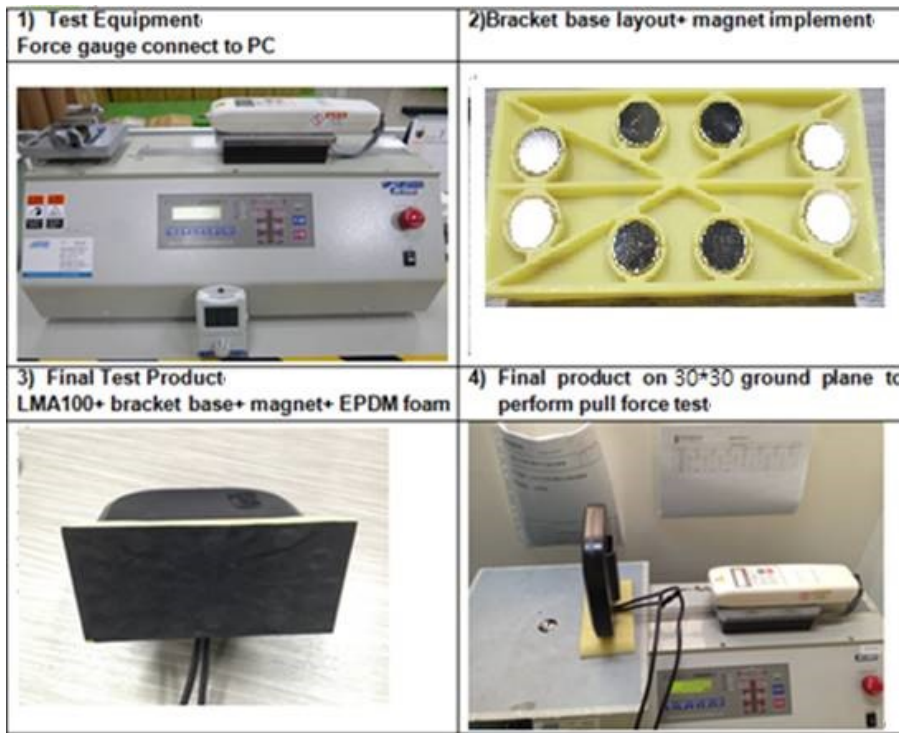

Maximum Pull Force: 11.24 Kgf-cm

9. Application Note

The LMA101 antenna performance with different cable lengths is shown below.

9.1. Antenna Isolation

9.1.1. Isolation between MIMO1 & MIMO2

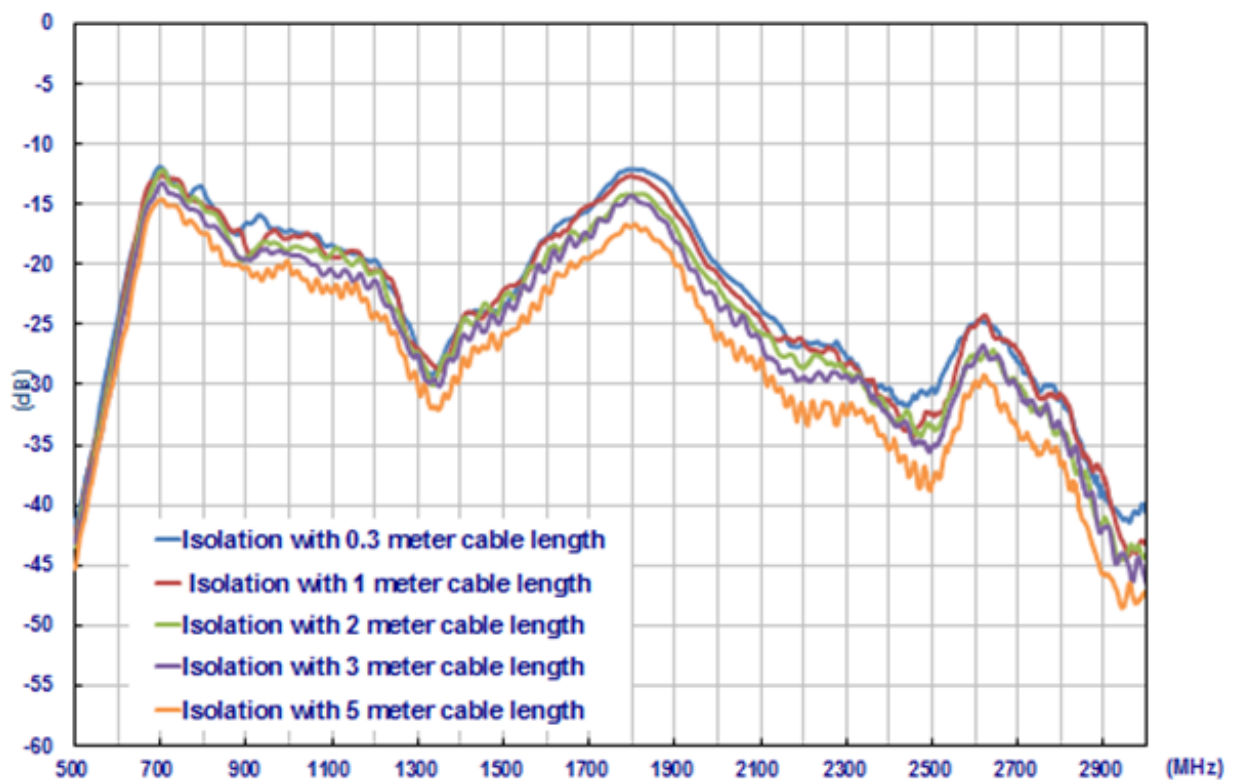

9.2. Return Loss

9.2.1. MIMO1

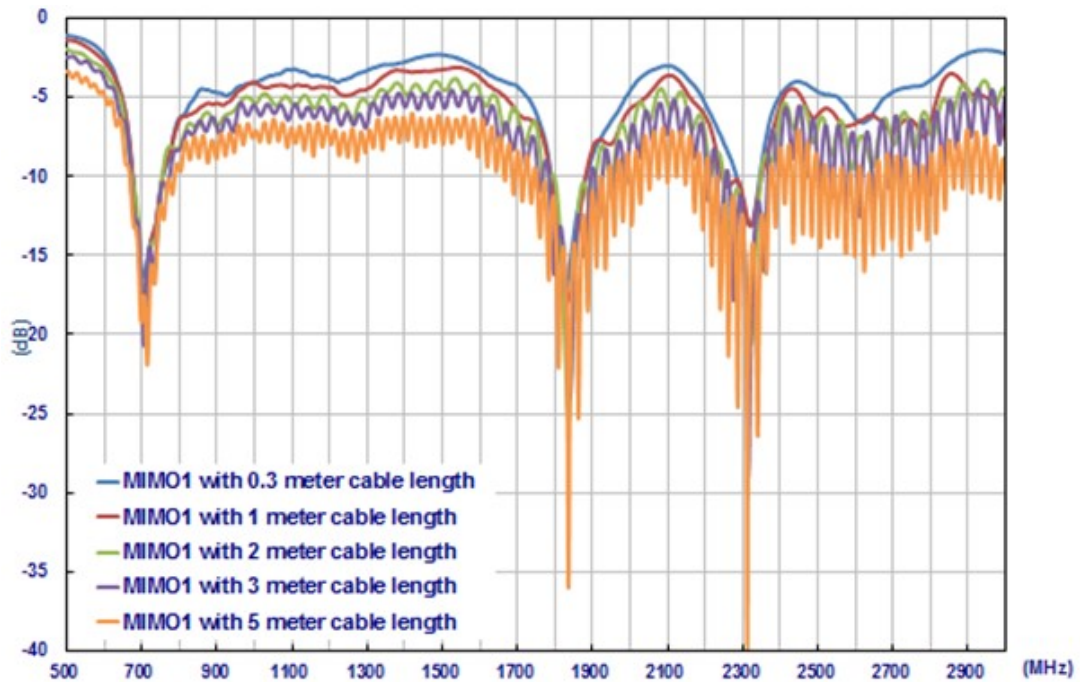

9.2.2. MIMO2

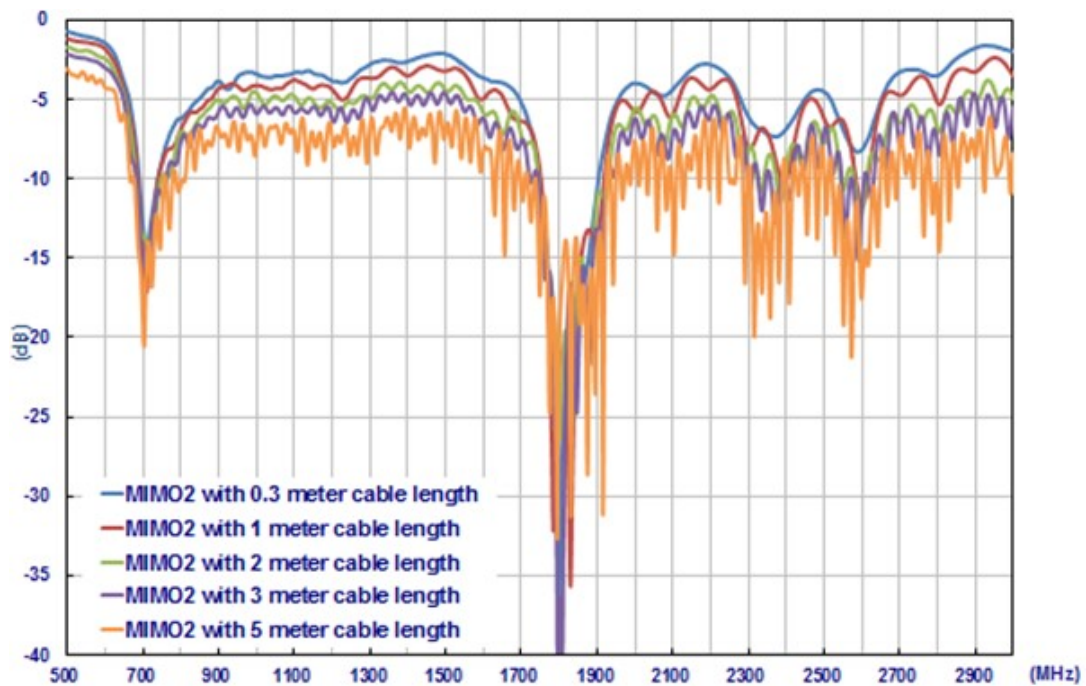

9.3. Efficiency

9.3.1. MIMO1

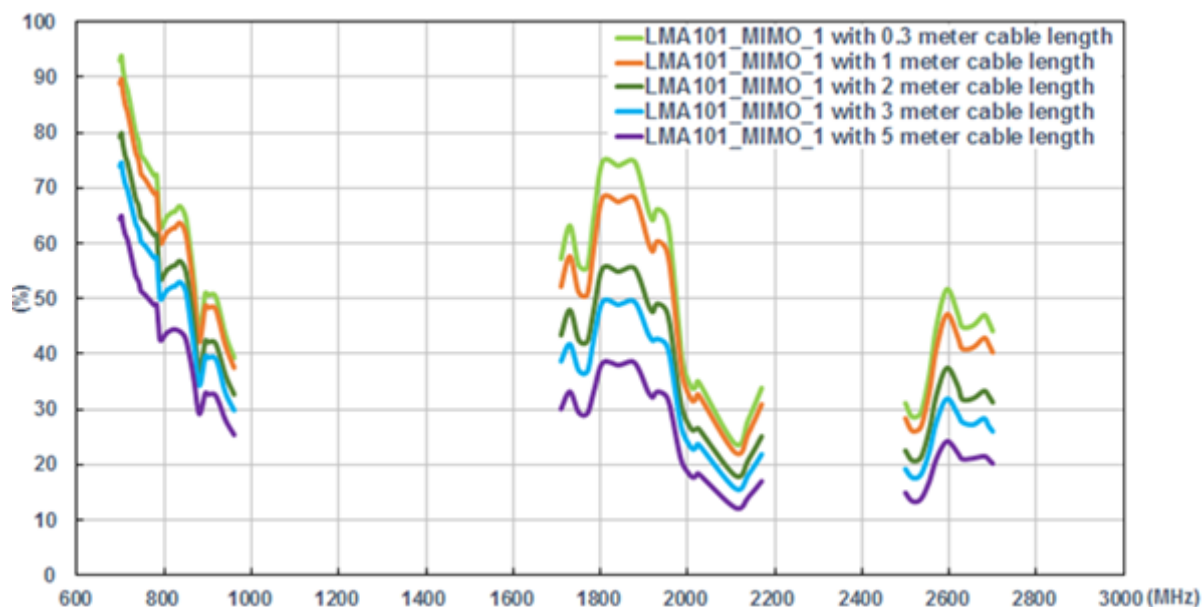

9.3.2. MIMO2

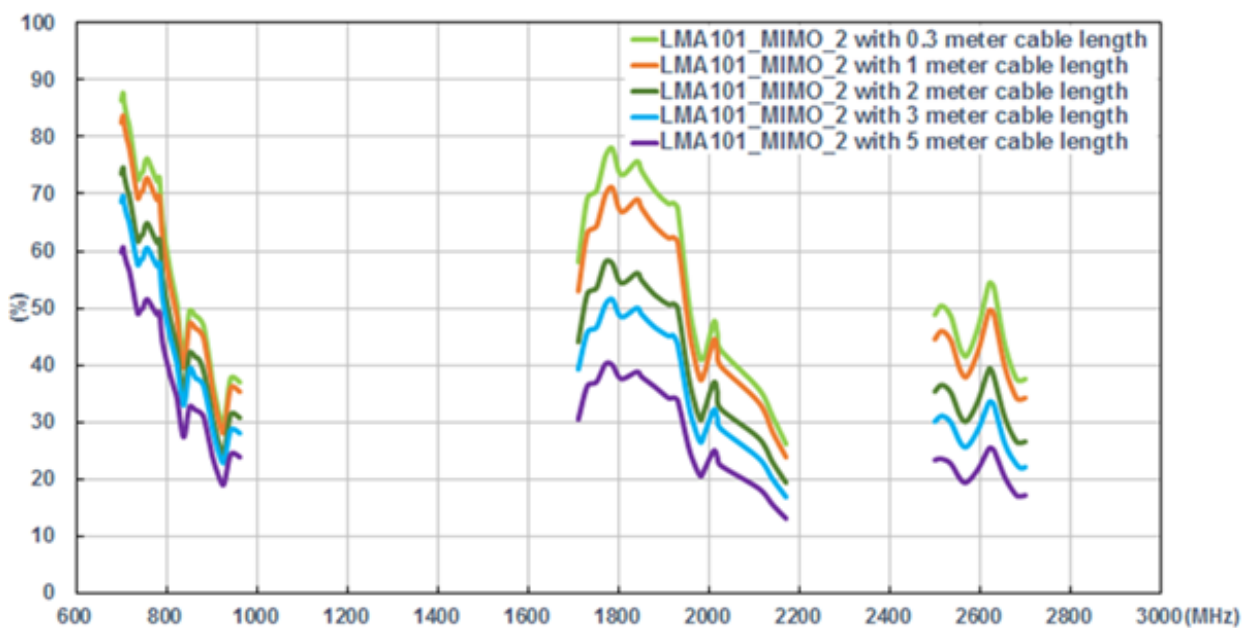

9.4. Average Gain

9.4.1. MIMO1

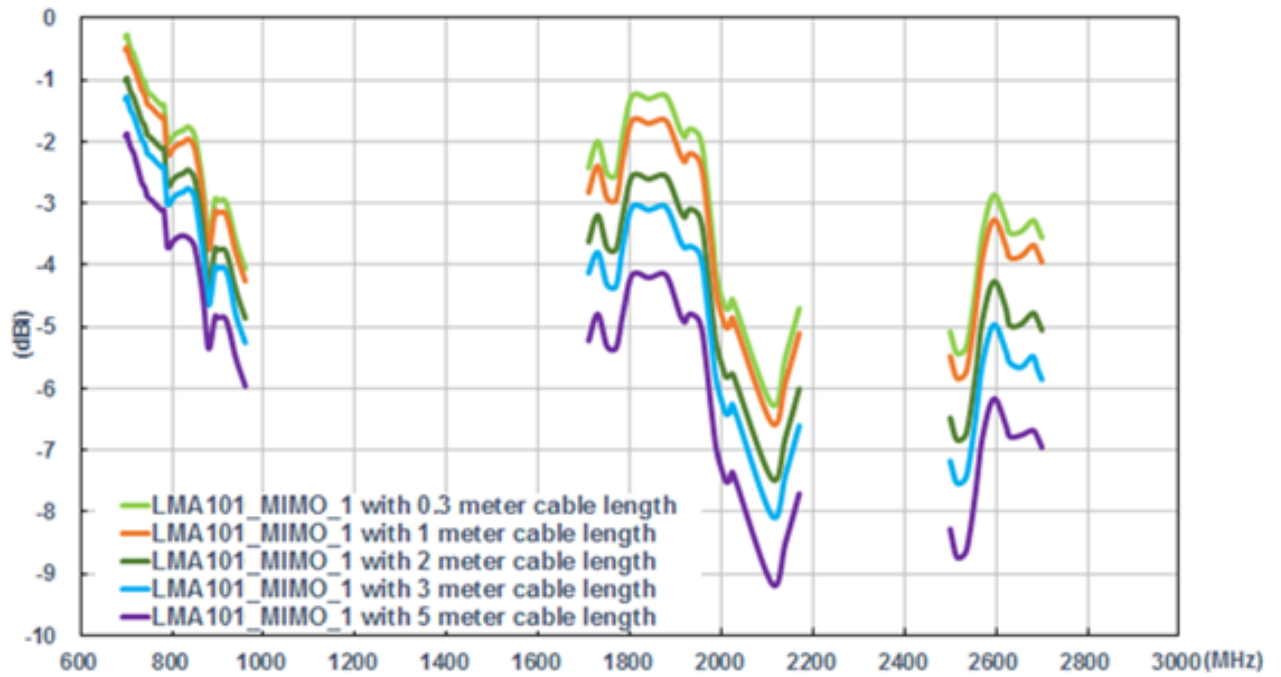

9.4.2. MIMO2

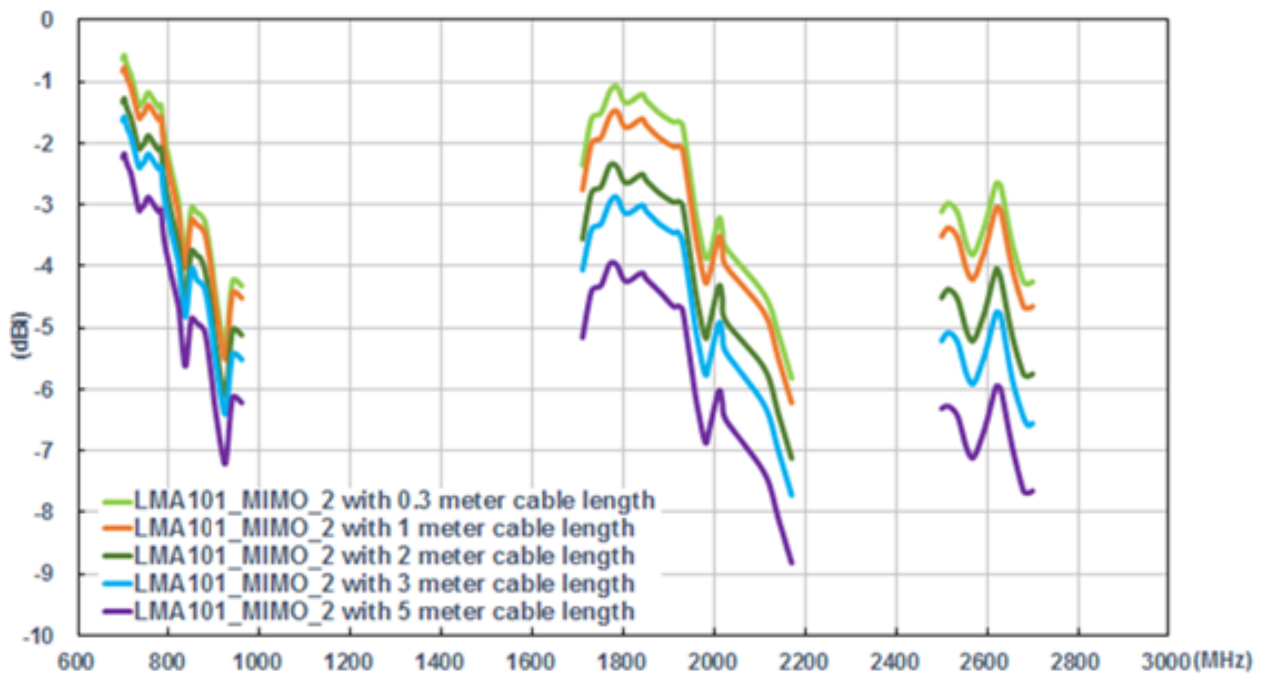

9.5. Peak Gain

9.5.1. MIMO1

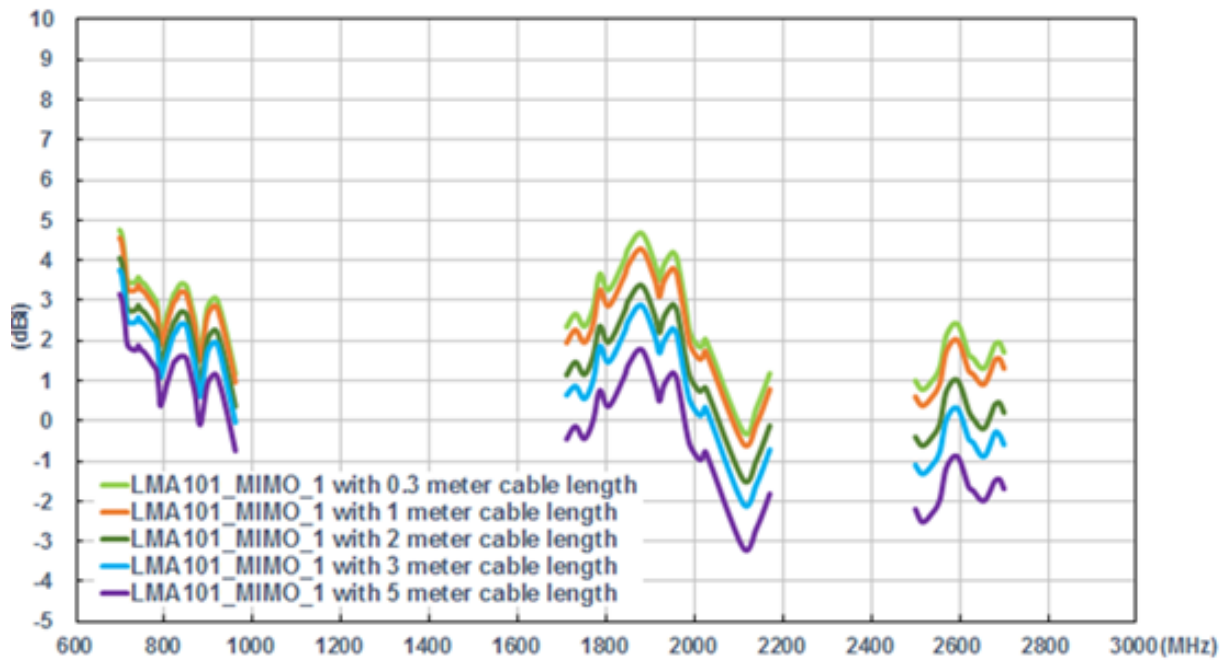

9.5.2. MIMO2

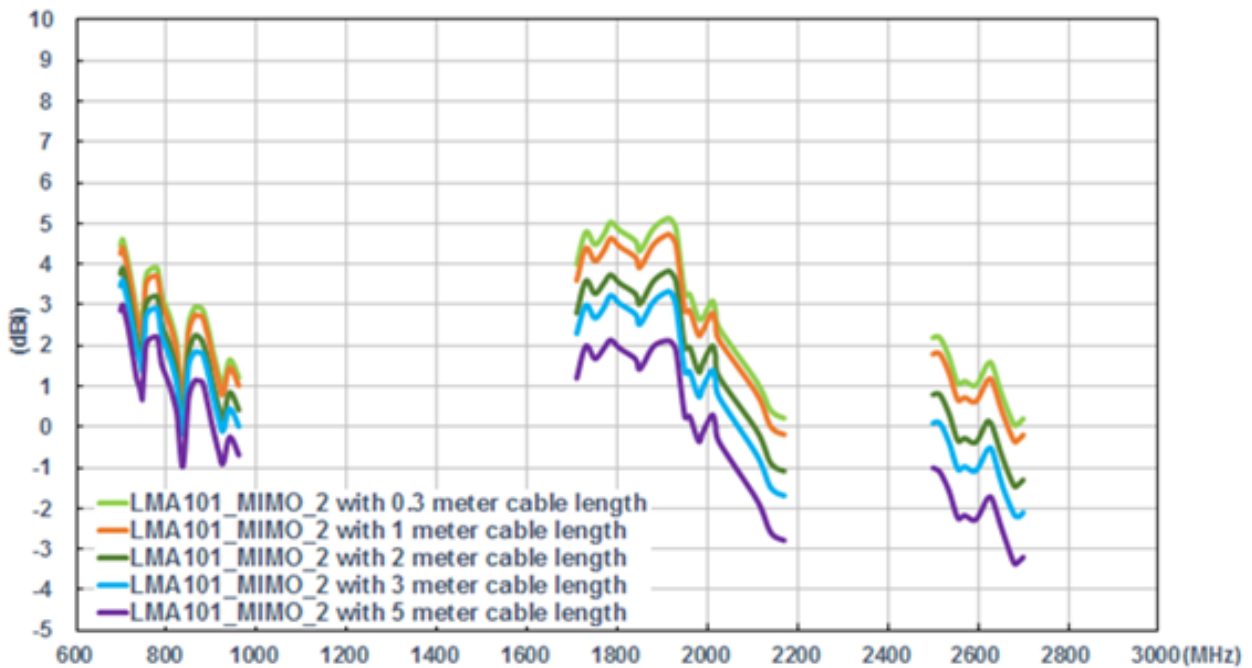



Taoglas makes no warranties based on the accuracy or completeness of the contents of this document and reserves the right to make changes to specifications and product descriptions at any time without notice. Taoglas reserves all rights to this document and the information contained herein.

Reproduction, use or disclosure to third parties without express permission is strictly prohibited.

Copyright © Taoglas Ltd.