

HWS-A SERIES Single Output 15W ~ 150W

UNIT -
PC Board

Contents

- HWS-A/HD ☞ a_HWS-A_15 Page
- HWS-A/ME ☞ a_HWS-A_25 Page
- Block Diagram, Sequence Time Chart ☞ a_HWS-A_35 Page
- Instruction Manual ☞ a_HWS-A_37 Page

HWS-A



15 - 150W standard :without cover HWS15A/A HWS30A/A HWS50A/A HWS80A/A HWS100A/A HWS150A/A

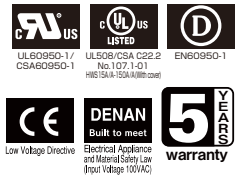

HWS-A

■ Features

- Environmentally-friendly
 - Contributing to energy conservation of the customer's equipment in a further high efficiency
 - Also improve efficiency at light load
 - Reduction of no-load power
- Easy to use
 - Enlarge ambient temperature to ensure the load factor of 100% to 50 °C from 40 °C , the customer's equipment is up the degree of freedom of the mechanism design even at high temperatures (Ambient temperature -10°C to +70°C)
- Safety and security
 - Reduce the maintenance frequency of your device by a long life
 - Double-sided board adopted inherited the conventional model
 - "Safety terminal" covering current flowing part secures safety for users. "No screw-dropping" design prevents from losing screws during maintenance operation.

■ Model naming method

[HWS15A-150A]

HWS 15A - 24 / □

Series name Output power

- Blank: Without cover(standard)
- /A : With cover
- /R : Remote ON/OFF control, without cover (HWS50A,80A,100A,150A only)
- /RA : Remote ON/OFF control, with cover (HWS50A,80A,100A,150A only)
- /ADIN : DIN rail mountable (24Vout of 15-150W models with cover only)
- /B : Connector connection(JST) (HWS50A,80A,100A,150A only, 100A and 150A,12V-48V only)

Nominal Output Voltage
ex. 3 : 3.3V, 5 : 5V, 48 : 48V

■ Applications

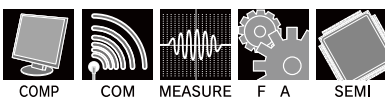

■ Conformity to RoHS Directive

This means that, in conformity with EU Directive 2011/65/EU, lead, cadmium, mercury, hexavalent chromium, and specific bromine-based flame retardants, PBB and PBDE, have not been used, except for exempted applications.

■ Product Line up

| Output Voltage | 15W | | 30W | | 50W | | 80W | | 100W | | 150W | |
|----------------|----------------|-----------|----------------|-----------|----------------|-----------|----------------|-----------|----------------|------------|----------------|------------|
| | Output Current | MODEL | Output Current | MODEL | Output Current | MODEL | Output Current | MODEL | Output Current | MODEL | Output Current | MODEL |
| 3.3V | 3A | HWS15A-3 | 6A | HWS30A-3 | 10A | HWS50A-3 | 16A | HWS80A-3 | 20A | HWS100A-3 | 30A | HWS150A-3 |
| 5V | 3A | HWS15A-5 | 6A | HWS30A-5 | 10A | HWS50A-5 | 16A | HWS80A-5 | 20A | HWS100A-5 | 30A | HWS150A-5 |
| 12V | 1.3A | HWS15A-12 | 2.5A | HWS30A-12 | 4.3A | HWS50A-12 | 6.7A | HWS80A-12 | 8.5A | HWS100A-12 | 13A | HWS150A-12 |
| 15V | 1A | HWS15A-15 | 2A | HWS30A-15 | 3.5A | HWS50A-15 | 5.4A | HWS80A-15 | 7A | HWS100A-15 | 10A | HWS150A-15 |
| 24V | 0.65A | HWS15A-24 | 1.3A | HWS30A-24 | 2.2A | HWS50A-24 | 3.4A | HWS80A-24 | 4.5A | HWS100A-24 | 6.5A | HWS150A-24 |
| 48V | 0.33A | HWS15A-48 | 0.65A | HWS30A-48 | 1.1A | HWS50A-48 | 1.7A | HWS80A-48 | 2.1A | HWS100A-48 | 3.3A | HWS150A-48 |

• All specifications are subject to change without notice.

HWS15A SPECIFICATIONS (Read instruction manual carefully, before using the power supply unit.)

UNIT
PC Board

| ITEMS/UNITS | | MODEL | HWS15A-3 | HWS15A-5 | HWS15A-12 | HWS15A-15 | HWS15A-24 | HWS15A-48 |
|-------------|---|-------|--|-------------|-------------|-------------|-------------|-------------|
| Input | Input Voltage Range (*2) | V | AC85 - 265 (47 - 63Hz) or DC120 - 370 | | | | | |
| | Efficiency(100VAC) (typ) (*1) | % | 70 | 77 | 80 | 81 | 82 | 82 |
| | Efficiency(200VAC) (typ) (*1) | % | 71 | 79 | 83 | 84 | 85 | 82 |
| | Input Current (100/200VAC) (typ) (*1) | A | 0.24/0.15 | 0.35/0.2 | | | | |
| | Inrush Current (100/200VAC) (typ) (*1)(*3) | A | 14/28 (Ta = 25°C, Cold Start) | | | | | |
| | Leakage Current (*9) | mA | Less than 0.5 (0.2 (typ) at 100VAC / 0.4 (typ) at 230VAC) | | | | | |
| Output | Nominal Output Voltage | VDC | 3.3 | 5 | 12 | 15 | 24 | 48 |
| | Maximum Output Current | A | 3 | 3 | 1.3 | 1 | 0.65 | 0.33 |
| | Maximum Output Power | W | 10.0 | 15.0 | 15.6 | 15.0 | 15.6 | 15.8 |
| | Maximum Line Regulation (*5) | mV | 20 | 20 | 48 | 60 | 96 | 192 |
| | Maximum Load Regulation (*6) | mV | 40 | 40 | 96 | 120 | 150 | 240 |
| | Temperature Coefficient | | Less than 0.02% /°C | | | | | |
| | Maximum Ripple & Noise(0≤Ta≤70°C) (*4) | mV | 120 | 120 | 150 | 150 | 150 | 200 |
| | Maximum Ripple & Noise(-10≤Ta<0°C) (*4) | mV | 160 | 160 | 180 | 180 | 180 | 240 |
| | Hold-up Time (typ) (*1) | ms | 20 | | | | | |
| | Output Voltage Range | VDC | 2.97 - 3.96 | 4.0 - 6.0 | 9.6 - 14.4 | 12.0 - 18.0 | 19.2 - 28.8 | 38.4 - 52.8 |
| Function | Over Current Protection (*7) | A | 3.15 — | 3.15 — | 1.36 — | 1.05 — | 0.68 — | 0.34 — |
| | Over Voltage Protection (*8) | VDC | 4.13 - 4.95 | 6.25 - 7.25 | 15.0 - 17.4 | 18.8 - 21.8 | 30.0 - 34.8 | 55.2 - 64.8 |
| | Remote Sensing | | - | | | | | |
| | Remote ON/OFF | | - | | | | | |
| | Parallel Operation | | - | | | | | |
| | Series Operation | | Possible | | | | | |
| | Line DIP | | Designed to meet SEMI-F47 (200VAC Line only) | | | | | |
| Environment | Operating Temperature (*10) | °C | -10 to +70 (-10 to +50°C :100%, +60°C :80%, +70°C :60%) | | | | | |
| | Storage Temperature | °C | -30 to +85 | | | | | |
| | Operating Humidity | % RH | 30 - 90 (No Condensing) | | | | | |
| | Storage Humidity | % RH | 10 - 95 (No Condensing) | | | | | |
| | Vibration | | At no operating, 10-55Hz (Sweep for 1min) 19.6m/s ² Constant, X,Y,Z 1hour each. | | | | | |
| | Shock | | Less than 196.1m/s ² | | | | | |
| | Cooling | | Convection Cooling | | | | | |
| Isolation | Withstand Voltage | | Input - FG : 2kVAC (20mA), Input - Output : 3kVAC (20mA) Output - FG : 500VAC (20mA) for 1min | | | | | |
| | Isolation Resistance | | More than 100MΩ at 25°C and 70%RH Output - FG : 500VDCC | | | | | |
| Standards | Safety | | Approved by UL60950-1, CSA60950-1, EN60950-1 Designed to meet Den-an Appendix 8 at 100VAC only. With cover models only : Approved by UL508, CSA C22.2 No.107.1-01. | | | | | |
| | PFHC | | Designed to meet IEC61000-3-2 | | | | | |
| | Conducted Emission, Radiated Emission (*11) | | Designed to meet EN55011/EN55022-B, FCC-B, VCCI-B | | | | | |
| | Immunity (*11) | | Designed to meet IEC61000-6-2 IEC61000-4-2, -3, -4, -5, -6, -8, -11 | | | | | |
| Mechanical | Weight (typ) | g | 160 (With cover: 190) | | | | | |
| | Size (W x H x D) | mm | 26.5 x 82 x 80 (Refer to Outline Drawing) | | | | | |

- (*1) At 100VAC/200VAC, Ta=25°C, nominal output voltage and maximum output power.
 (*2) For cases where conformance to various safety specs (UL, CSA, EN) are required, to be described as 100 - 240VAC(50 - 60Hz).
 (*3) Not applicable for the inrush current to Noise Filter for less than 0.2ms.
 (*4) Measure with JEITA RC-9131B probe, Bandwidth of scope :100MHz.
 For start up at low ambient temperature and low input voltage, output ripple noise might not meet specification.
 However, specification can be met after one second.
 (*5) 85 - 265VAC, constant load.
 (*6) No load-Full load, constant input voltage.
 (*7) Hiccup with automatic recovery. Avoid to operate at over load or short circuit condition.
 (*8) OVP circuit will shut down output, manual reset (Re power on).
 (*9) Measured by the each measuring method of UL, CSA, EN and Den-an (at 60Hz), Ta=25°C.
 (*10) Output Derating
 - Refer to Output Derating Curve.
 - Load (%) is percent of maximum output power or maximum output current, do not exceed its derating of maximum load.
 (*11) The power supply is considered a component which will be installed into a final equipment.
 The final equipment should be re-evaluated that it meets EMC directives.

Recommended EMC Filter

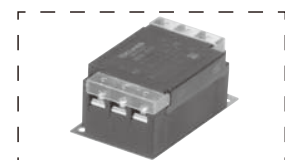

RSEN-2003D or RSEN-2003
 Please refer to "TDK-Lambda
 EMC Filters" catalog.

Outline Drawing

UNIT - PC Board

[HWS15A]

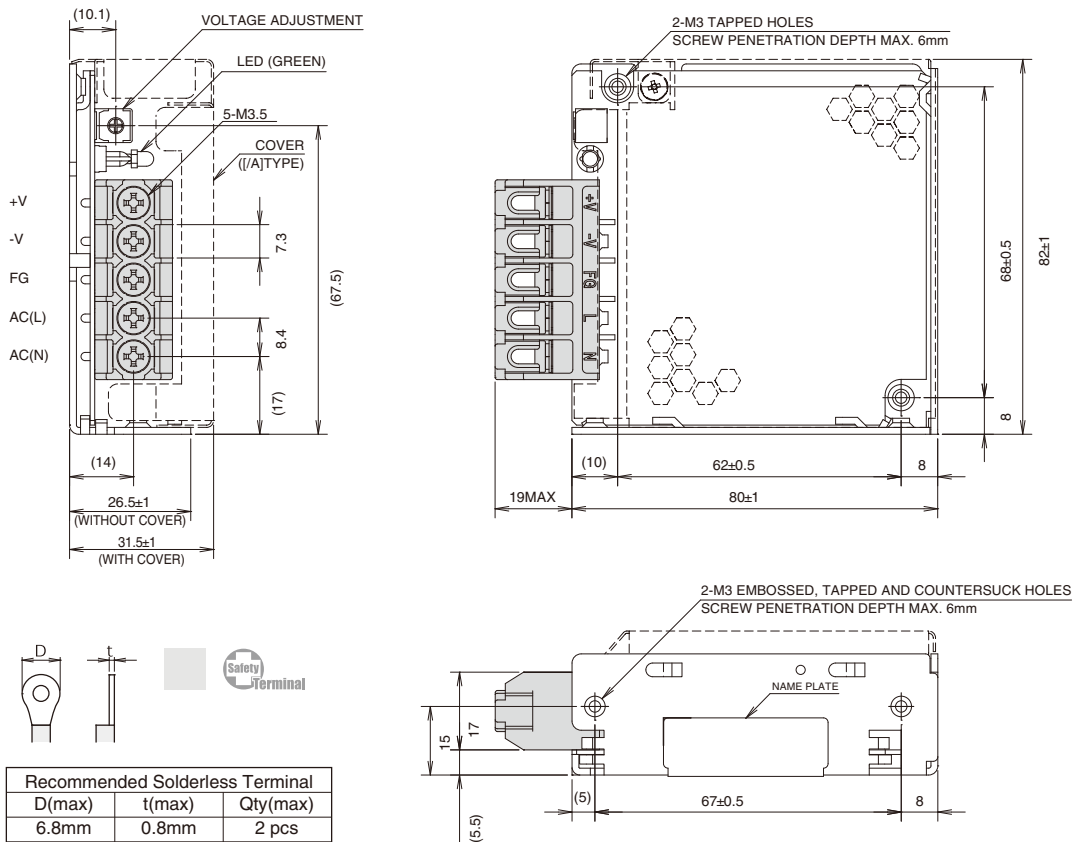

HWS-A

[unit: mm]

Output Derating

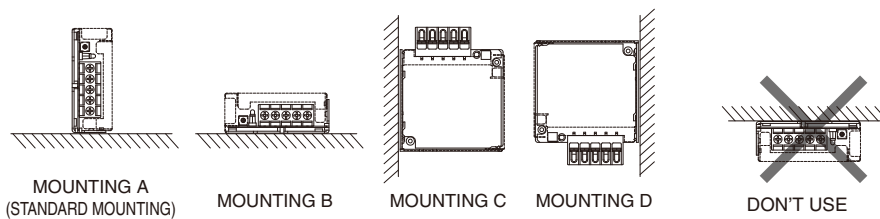
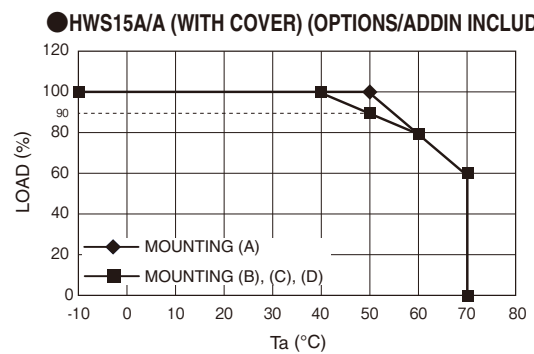
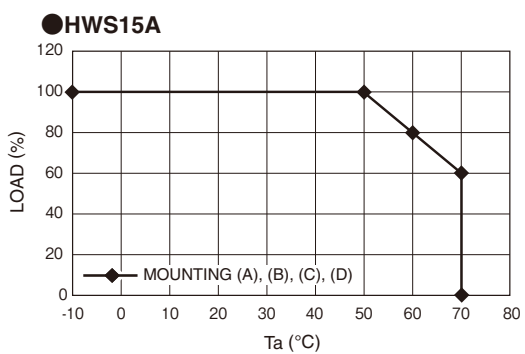

• All specifications are subject to change without notice.

HWS30A SPECIFICATIONS (Read instruction manual carefully, before using the power supply unit.)

UNIT
PC Board

| ITEMS/UNITS | | MODEL | HWS30A-3 | HWS30A-5 | HWS30A-12 | HWS30A-15 | HWS30A-24 | HWS30A-48 | |
|-------------|---|-------|--|-------------|-------------|-------------|-------------|-------------|--|
| Input | Input Voltage Range (*2) | V | AC85 - 265 (47 - 63Hz) or DC120 - 370 | | | | | | |
| | Efficiency(100VAC) (typ) (*1) | % | 75 | 80 | 84 | 85 | 86 | 86 | |
| | Efficiency(200VAC) (typ) (*1) | % | 77 | 82 | 86 | 87 | 88 | 87 | |
| | Input Current (100/200VAC) (typ) (*1) | A | 0.5/0.3 | 0.65/0.4 | | | | | |
| | Inrush Current (100/200VAC) (typ) (*1)(*3) | A | 14/28 (Ta = 25°C, Cold Start) | | | | | | |
| | Leakage Current (*9) | mA | Less than 0.5 (0.2 (typ) at 100VAC / 0.4 (typ) at 230VAC) | | | | | | |
| Output | Nominal Output Voltage | VDC | 3.3 | 5 | 12 | 15 | 24 | 48 | |
| | Maximum Output Current | A | 6 | 6 | 2.5 | 2 | 1.3 | 0.65 | |
| | Maximum Output Power | W | 20.0 | 30.0 | 30.0 | 30.0 | 31.2 | 31.2 | |
| | Maximum Line Regulation (*5) | mV | 20 | 20 | 48 | 60 | 96 | 192 | |
| | Maximum Load Regulation (*6) | mV | 40 | 40 | 96 | 120 | 150 | 240 | |
| | Temperature Coefficient | | Less than 0.02% /°C | | | | | | |
| | Maximum Ripple & Noise(0≤Ta≤70°C) (*4) | mV | 120 | 120 | 150 | 150 | 150 | 200 | |
| | Maximum Ripple & Noise(-10≤Ta<0°C) (*4) | mV | 160 | 160 | 180 | 180 | 180 | 240 | |
| | Hold-up Time (typ) (*1) | ms | 20 | | | | | | |
| | Output Voltage Range | VDC | 2.97 - 3.96 | 4.0 - 6.0 | 9.6 - 14.4 | 12.0 - 18.0 | 19.2 - 28.8 | 38.4 - 52.8 | |
| Function | Over Current Protection (*7) | A | 6.3 — | 6.3 — | 2.62 — | 2.1 — | 1.36 — | 0.68 — | |
| | Over Voltage Protection (*8) | VDC | 4.13 - 4.95 | 6.25 - 7.25 | 15.0 - 17.4 | 18.8 - 21.8 | 30.0 - 34.8 | 55.2 - 64.8 | |
| | Remote Sensing | | - | | | | | | |
| | Remote ON/OFF | | - | | | | | | |
| | Parallel Operation | | - | | | | | | |
| | Series Operation | | Possible | | | | | | |
| | Line DIP | | Designed to meet SEMI-F47 (200VAC Line only) | | | | | | |
| Environment | Operating Temperature (*10) | °C | -10 to +70 (-10 to +50°C :100%, +60°C :60%, +70°C :40%) | | | | | | |
| | Storage Temperature | °C | -30 to +85 | | | | | | |
| | Operating Humidity | % RH | 30 - 90 (No Condensing) | | | | | | |
| | Storage Humidity | % RH | 10 - 95 (No Condensing) | | | | | | |
| | Vibration | | At no operating, 10-55Hz (Sweep for 1min) 19.6m/s ² Constant, X,Y,Z 1hour each. | | | | | | |
| | Shock | | Less than 196.1m/s ² | | | | | | |
| | Cooling | | Convection Cooling | | | | | | |
| Isolation | Withstand Voltage | | Input - FG : 2kVAC (20mA), Input - Output : 3kVAC (20mA) Output - FG : 500VAC (20mA) for 1min | | | | | | |
| | Isolation Resistance | | More than 100MΩ at 25°C and 70%RH Output - FG : 500VDCC | | | | | | |
| Standards | Safety | | Approved by UL60950-1, CSA60950-1, EN60950-1 Designed to meet Den-an Appendix 8 at 100VAC only. With cover models only : Approved by UL508, CSA C22.2 No.107.1-01. | | | | | | |
| | PFHC | | Designed to meet IEC61000-3-2 | | | | | | |
| | Conducted Emission, Radiated Emission (*11) | | Designed to meet EN55011/EN55022-B, FCC-B, VCCI-B | | | | | | |
| | Immunity (*11) | | Designed to meet IEC61000-6-2 IEC61000-4-2, -3, -4, -5, -6, -8, -11 | | | | | | |
| Mechanical | Weight (typ) | g | 200 (With cover: 240) | | | | | | |
| | Size (W x H x D) | mm | 26.5 x 82 x 95 (Refer to Outline Drawing) | | | | | | |

(*1) At 100VAC/200VAC, Ta=25°C, nominal output voltage and maximum output power.

(*2) For cases where conformance to various safety specs (UL, CSA, EN) are required, to be described as 100 - 240VAC(50 - 60Hz).

(*3) Not applicable for the inrush current to Noise Filter for less than 0.2ms.

(*4) Measure with JEITA RC-9131B probe, Bandwidth of scope :100MHz.

For start up at low ambient temperature and low input voltage, output ripple noise might not meet specification. However, specification can be met after one second.

(*5) 85 - 265VAC, constant load.

(*6) No load-Full load, constant input voltage.

(*7) Hiccup with automatic recovery. Avoid to operate at over load or short circuit condition.

(*8) OVP circuit will shut down output, manual reset (Re power on).

(*9) Measured by the each measuring method of UL, CSA, EN and Den-an (at 60Hz), Ta=25°C.

(*10) Output Derating

- Refer to Output Derating Curve.

- Load (%) is percent of maximum output power or maximum output current, do not exceed its derating of maximum load.

(*11) The power supply is considered a component which will be installed into a final equipment.

The final equipment should be re-evaluated that it meets EMC directives.

Recommended EMC Filter

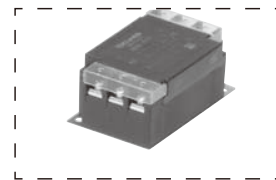

RSEN-2003D or RSEN-2003

Please refer to "TDK-Lambda EMC Filters" catalog.

Outline Drawing

UNIT - PC Board

[HWS30A]

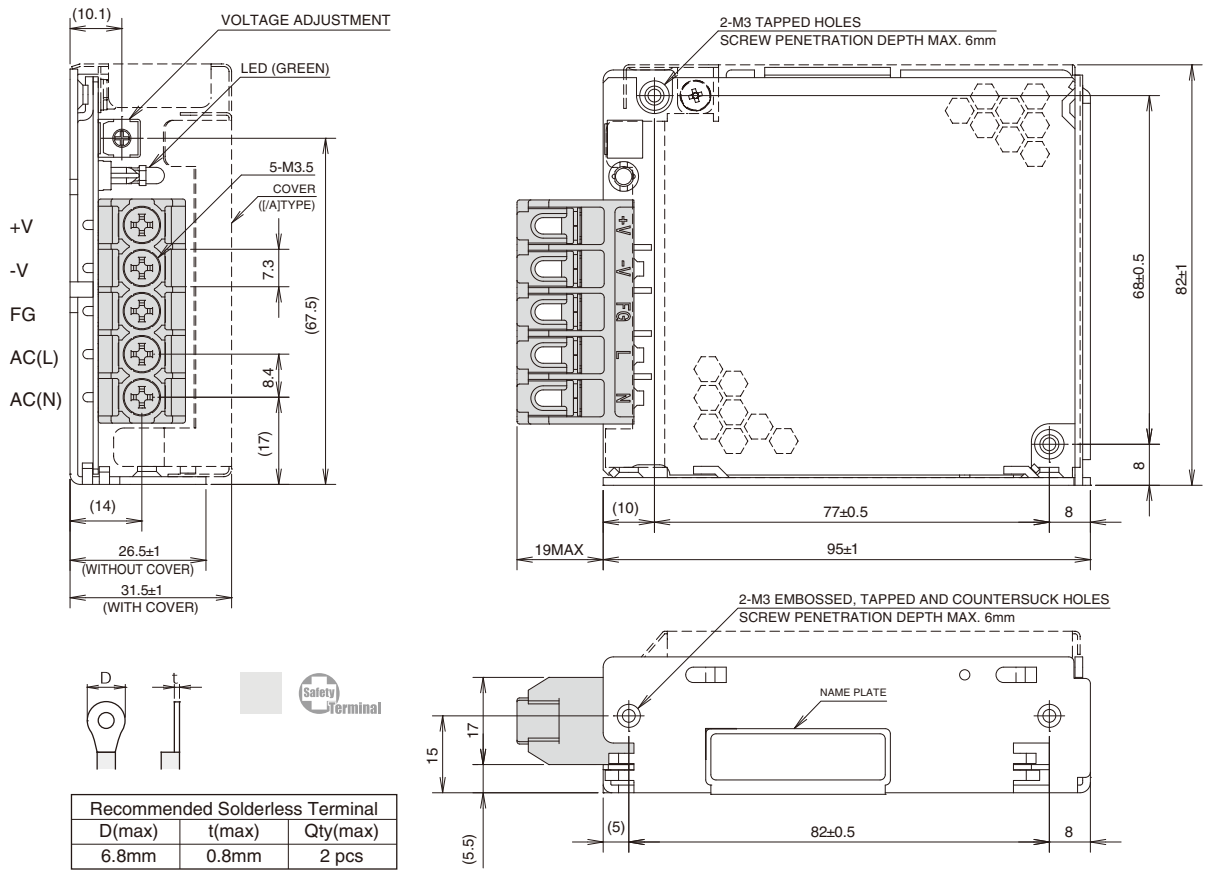

[unit: mm]

HWS-A

Output Derating

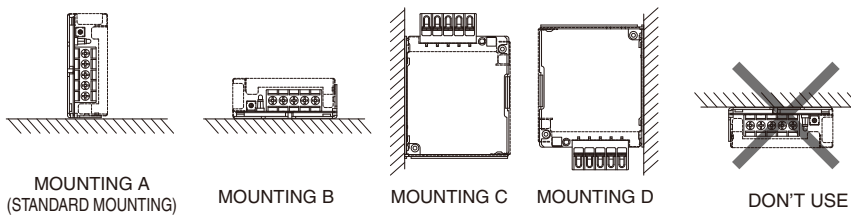
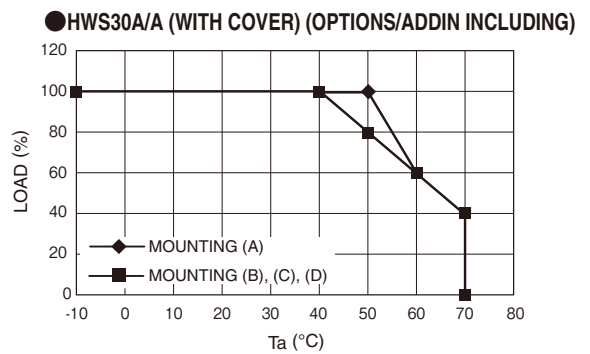
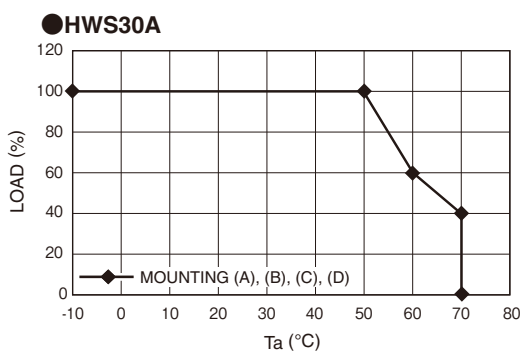

• All specifications are subject to change without notice.

HWS50A SPECIFICATIONS (Read instruction manual carefully, before using the power supply unit.)

UNIT
PC Board

HWS-A

| ITEMS/UNITS | | MODEL | HWS50A-3 | HWS50A-5 | HWS50A-12 | HWS50A-15 | HWS50A-24 | HWS50A-48 |
|----------------------|---|---|--|-------------|-------------|-------------|-------------|-------------|
| Input | Input Voltage Range (*2) | V | AC85 - 265 (47 - 63Hz) or DC120 - 370 | | | | | |
| | Power Factor(100/200VAC) (typ) (*1) | | 0.96/0.85 | 0.97/0.91 | | | | |
| | Efficiency(100VAC) (typ) (*1) | % | 76 | 82 | 83 | 83 | 84 | 84 |
| | Efficiency(200VAC) (typ) (*1) | % | 78 | 84 | 85 | 86 | 87 | 86 |
| | Input Current (100/200VAC) (typ) (*1) | A | 0.45/0.25 | 0.65/0.35 | | | | |
| | Inrush Current (100/200VAC) (typ) (*1)(*3) | A | 14/28 (Ta = 25°C, Cold Start) | | | | | |
| Leakage Current (*9) | mA | Less than 0.5 (0.2 (typ) at 100VAC / 0.4 (typ) at 230VAC) | | | | | | |
| Output | Nominal Output Voltage | VDC | 3.3 | 5 | 12 | 15 | 24 | 48 |
| | Maximum Output Current | A | 10 | 10 | 4.3 | 3.5 | 2.2 | 1.1 |
| | Maximum Output Power | W | 33.0 | 50.0 | 51.6 | 52.5 | 52.8 | 52.8 |
| | Maximum Line Regulation (*5) | mV | 20 | 20 | 48 | 60 | 96 | 192 |
| | Maximum Load Regulation (*6) | mV | 40 | 40 | 96 | 120 | 150 | 240 |
| | Temperature Coefficient | | Less than 0.02% /°C | | | | | |
| | Maximum Ripple & Noise(0≤Ta≤70°C) (*4) | mV | 120 | 120 | 150 | 150 | 150 | 200 |
| | Maximum Ripple & Noise(-10≤Ta<0°C) (*4) | mV | 160 | 160 | 180 | 180 | 180 | 240 |
| | Hold-up Time (typ) (*1) | ms | 20 | | | | | |
| | Output Voltage Range | VDC | 2.97 - 3.96 | 4.0 - 6.0 | 9.6 - 14.4 | 12.0 - 18.0 | 19.2 - 28.8 | 38.4 - 52.8 |
| Function | Over Current Protection (*7) | A | 10.5 — | 10.5 — | 4.51 — | 3.67 — | 2.31 — | 1.15 — |
| | Over Voltage Protection (*8) | VDC | 4.13 - 4.95 | 6.25 - 7.25 | 15.0 - 17.4 | 18.8 - 21.8 | 30.0 - 34.8 | 55.2 - 64.8 |
| | Remote Sensing | | - | | | | | |
| | Remote ON/OFF | | - (/R Option: Output ON in the external voltage is applied) | | | | | |
| | Parallel Operation | | - | | | | | |
| | Series Operation | | Possible | | | | | |
| | Line DIP | | Designed to meet SEMI-F47 (200VAC Line only) | | | | | |
| Environment | Operating Temperature (*10) | °C | -10 to +70 (-10 to +50°C :100%, +60°C :70%, +70°C :40%) | | | | | |
| | Storage Temperature | °C | -30 to +85 | | | | | |
| | Operating Humidity | % RH | 30 - 90 (No Condensing) | | | | | |
| | Storage Humidity | % RH | 10 - 95 (No Condensing) | | | | | |
| | Vibration | | At no operating, 10-55Hz (Sweep for 1min) 19.6m/s ² Constant, X,Y,Z 1hour each. | | | | | |
| | Shock | | Less than 196.1m/s ² | | | | | |
| | Cooling | | Convection Cooling | | | | | |
| Isolation | Withstand Voltage | | Input - FG : 2kVAC (20mA), Input - Output : 3kVAC (20mA) Output - FG : 500VAC (20mA) for 1min | | | | | |
| | Isolation Resistance | | More than 100MΩ at 25°C and 70%RH Output - FG : 500VDCC | | | | | |
| Standards | Safety | | Approved by UL60950-1, CSA60950-1, EN60950-1 Designed to meet Den-an Appendix 8 at 100VAC only. With cover models only : Approved by UL508, CSA C22.2 No.107.1-01. | | | | | |
| | PFHC | | Designed to meet IEC61000-3-2 | | | | | |
| | Conducted Emission, Radiated Emission (*11) | | Designed to meet EN55011/EN55022-B, FCC-B, VCCI-B | | | | | |
| | Immunity (*11) | | Designed to meet IEC61000-6-2 IEC61000-4-2, -3, -4, -5, -6, -8, -11 | | | | | |
| Mechanical | Weight (typ) | g | 260 (With cover: 300) | | | | | |
| | Size (W x H x D) | mm | 26.5 x 82 x 120 (Refer to Outline Drawing) | | | | | |

(*1) At 100VAC/200VAC, Ta=25°C, nominal output voltage and maximum output power.

(*2) For cases where conformance to various safety specs (UL, CSA, EN) are required, to be described as 100 - 240VAC(50 - 60Hz).

(*3) Not applicable for the inrush current to Noise Filter for less than 0.2ms.

(*4) Measure with JEITA RC-9131B probe, Bandwidth of scope :100MHz.

(*5) 85 - 265VAC, constant load.

(*6) No load-Full load, constant input voltage.

(*7) Hiccup with automatic recovery. Avoid to operate at over load or short circuit condition.

(*8) OVP circuit will shut down output, manual reset (Re power on).

(*9) Measured by the each measuring method of UL, CSA, EN and Den-an (at 60Hz), Ta=25°C.

(*10) Output Derating

- Refer to Output Derating Curve.

- Load (%) is percent of maximum output power or maximum output current, do not exceed its derating of maximum load.

(*11) The power supply is considered a component which will be installed into a final equipment.

The final equipment should be re-evaluated that it meets EMC directives.

Recommended EMC Filter

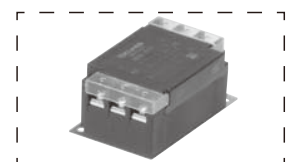

RSEN-2003D or RSEN-2003
Please refer to "TDK-Lambda
EMC Filters" catalog.

Outline Drawing

[HWS50A]

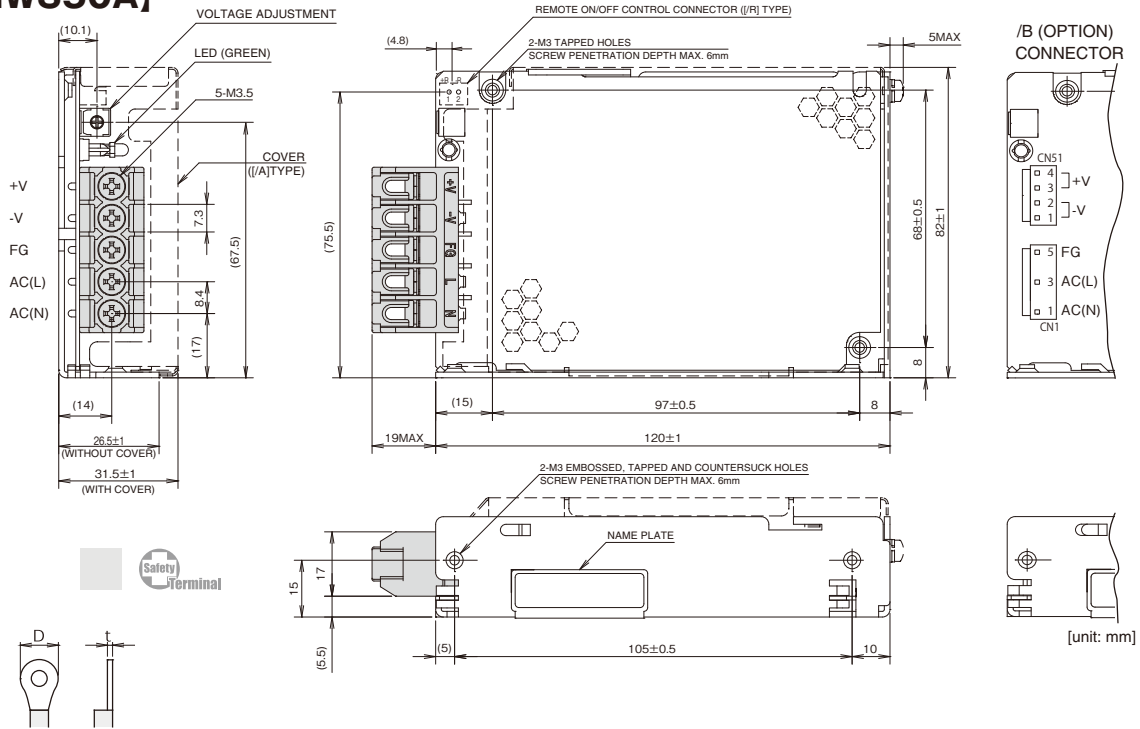

| Recommended Solderless Terminal | | |
|---------------------------------|--------|----------|
| D(max) | t(max) | Qty(max) |
| 6.8mm | 0.8mm | 2 pcs |

/R (Option)
Remote ON / OFF control connector (JST)

| | |
|--------------------|--------------------------------|
| PIN HEADER | B2B-XH-AM |
| SOCKET HOUSING | XHP-2 |
| TERMINAL PINS | BXH-001T-P0.6 or SXH-001T-P0.6 |
| HAND CRIMPING TOOL | YC-110R or YRS-110 |

※ Housing and terminal pin are not attached to the product.

/B (Option) Use connector

| PART DESCRIPTION | PART NAME | MANUFACT | QTY |
|-----------------------------|-----------------|----------|-----|
| CONNECTOR INPUT SIDE(CN1) | B3P5-VH(LF)(SN) | JST | 1 |
| CONNECTOR OUTPUT SIDE(CN51) | B4P-VH(LF)(SN) | JST | 1 |

※ Output terminal, please use one pin per 5A below.

/B (Option) Recommended connector (it is not affixed to the product)

| PART DESCRIPTION | PART NAME | MANUFACT | QTY |
|--------------------------|------------------------------|----------|-----|
| SOCKET HOUSING (CN1) | VHR-5N | JST | 1 |
| SOCKET HOUSING (CN51) | VHR-4N | JST | 1 |
| TERMINAL PINS (CN1,CN51) | BVH-21T-P1.1 or SVH-21T-P1.1 | JST | 7 |

HAND CRIMPING TOOL: YC-160R (JST)

Output Derating

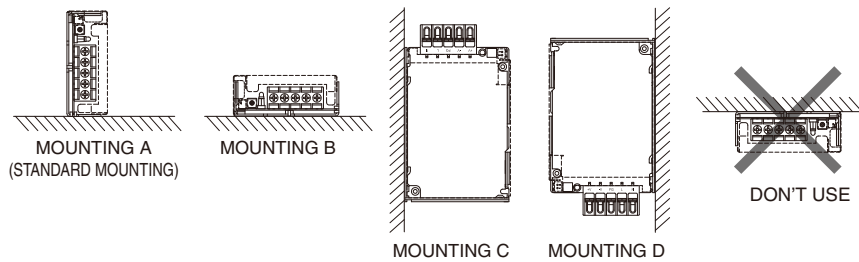
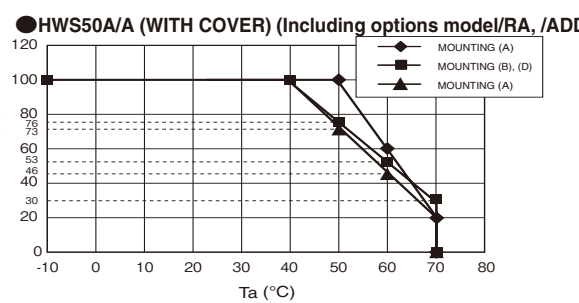
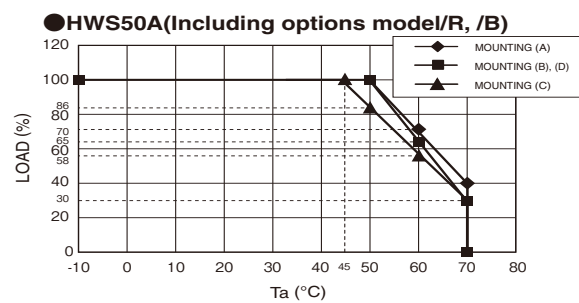

• All specifications are subject to change without notice.

HWS80A SPECIFICATIONS (Read instruction manual carefully, before using the power supply unit.)

UNIT
PC Board

| ITEMS/UNITS | | MODEL | HWS80A-3 | HWS80A-5 | HWS80A-12 | HWS80A-15 | HWS80A-24 | HWS80A-48 |
|----------------------|---|---|--|-------------|-------------|-------------|-------------|-------------|
| Input | Input Voltage Range (*2) | V | AC85 - 265 (47 - 63Hz) or DC120 - 370 | | | | | |
| | Power Factor(100/200VAC) (typ) (*1) | | 0.96/0.87 | | 0.98/0.91 | | | |
| | Efficiency(100VAC) (typ) (*1) | % | 81 | 83 | 85 | 85 | 86 | 87 |
| | Efficiency(200VAC) (typ) (*1) | % | 83 | 85 | 87 | 87 | 88 | 89 |
| | Input Current (100/200VAC) (typ) (*1) | A | 0.72/0.36 | | 1.04/0.52 | | | |
| | Inrush Current (100/200VAC) (typ) (*1)(*3) | A | 14/28 (Ta = 25°C, Cold Start) | | | | | |
| Leakage Current (*9) | mA | Less than 0.5 (0.2 (typ) at 100VAC / 0.4 (typ) at 230VAC) | | | | | | |
| Output | Nominal Output Voltage | VDC | 3.3 | 5 | 12 | 15 | 24 | 48 |
| | Maximum Output Current | A | 16 | 16 | 6.7 | 5.4 | 3.4 | 1.7 |
| | Maximum Output Power | W | 52.8 | 80.0 | 80.4 | 81.0 | 81.6 | 81.6 |
| | Maximum Line Regulation (*5) | mV | 20 | 20 | 48 | 60 | 96 | 192 |
| | Maximum Load Regulation (*6) | mV | 40 | 40 | 96 | 120 | 150 | 240 |
| | Temperature Coefficient | | Less than 0.02% /°C | | | | | |
| | Maximum Ripple & Noise(0≤Ta≤70°C) (*4) | mV | 120 | 120 | 150 | 150 | 150 | 200 |
| | Maximum Ripple & Noise(-10≤Ta<0°C) (*4) | mV | 160 | 160 | 180 | 180 | 180 | 240 |
| | Hold-up Time (typ) (*1) | ms | 20 | | | | | |
| | Output Voltage Range | VDC | 2.97 - 3.96 | 4.0 - 6.0 | 9.6 - 14.4 | 12.0 - 18.0 | 19.2 - 28.8 | 38.4 - 52.8 |
| Function | Over Current Protection (*7) | A | 16.8 — | 16.8 — | 7.04 — | 5.67 — | 3.57 — | 1.79 — |
| | Over Voltage Protection (*8) | VDC | 4.13 - 4.95 | 6.25 - 7.25 | 15.0 - 17.4 | 18.8 - 21.8 | 30.0 - 34.8 | 55.2 - 64.8 |
| | Remote Sensing | | Possible | | | | | |
| | Remote ON/OFF | | - (/R Option: Output ON in the external voltage is applied) | | | | | |
| | Parallel Operation | | - | | | | | |
| | Series Operation | | Possible | | | | | |
| | Line DIP | | Designed to meet SEMI-F47(200VAC Line only) | | | | | |
| Environment | Operating Temperature (*10) | °C | -10 ~ +70(-10 ~ +50°C :100%, +60°C :80%, +70°C :60%) | | | | | |
| | Storage Temperature | °C | -30 to +85 | | | | | |
| | Operating Humidity | % RH | 30 - 90 (No Condensing) | | | | | |
| | Storage Humidity | % RH | 10 - 95 (No Condensing) | | | | | |
| | Vibration | | At no operating, 10-55Hz (Sweep for 1min) 19.6m/s ² Constant, X,Y,Z 1hour each. | | | | | |
| | Shock | | Less than 196.1m/s ² | | | | | |
| | Cooling | | Convection Cooling | | | | | |
| Isolation | Withstand Voltage | | Input - FG : 2kVAC (20mA), Input - Output : 3kVAC (20mA) Output - FG : 500VAC (20mA) for 1min | | | | | |
| | Isolation Resistance | | More than 100MΩ at 25°C and 70%RH Output - FG : 500VDCC | | | | | |
| Standards | Safety | | Approved by UL60950-1, CSA60950-1, EN60950-1 Designed to meet Den-an Appendix 8 at 100VAC only. With cover models only : Approved by UL508, CSA C22.2 No.107.1-01. | | | | | |
| | PFHC | | Designed to meet IEC61000-3-2 | | | | | |
| | Conducted Emission, Radiated Emission (*11) | | Designed to meet EN55011/EN55022-B, FCC-B, VCCI-B | | | | | |
| | Immunity (*11) | | Designed to meet IEC61000-6-2 IEC61000-4-2, -3, -4, -5, -6, -8, -11 | | | | | |
| Mechanical | Weight (typ) | g | 420 (With cover: 470) | | | | | |
| | Size (W x H x D) | mm | 28 x 82 x 160 (Refer to Outline Drawing) | | | | | |

- (*1) At 100VAC/200VAC, Ta=25°C, nominal output voltage and maximum output power.
 (*2) For cases where conformance to various safety specs (UL, CSA, EN) are required, to be described as 100 - 240VAC(50 - 60Hz).
 (*3) Not applicable for the inrush current to Noise Filter for less than 0.2ms.
 (*4) Measure with JEITA RC-9131B probe, Bandwidth of scope :100MHz.
 (*5) 85 - 265VAC, constant load.
 (*6) No load-Full load, constant input voltage.
 (*7) Constant current limit and hiccup with automatic recovery.
 Avoid to operate at over load or short circuit condition.
 (*8) OVP circuit will shut down output, manual reset (Re power on).
 (*9) Measured by the each measuring method of UL, CSA, EN and Den-an (at 60Hz), Ta=25°C.
 (*10) Output Derating
 - Refer to Output Derating Curve.
 - Load (%) is percent of maximum output power or maximum output current, do not exceed its derating of maximum load.
 (*11) The power supply is considered a component which will be installed into a final equipment.
 The final equipment should be re-evaluated that it meets EMC directives.

Recommended EMC Filter

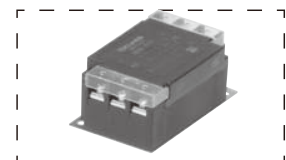

RSEN-2003D or RSEN-2003
 Please refer to "TDK-Lambda
 EMC Filters" catalog.

Outline Drawing

[HWS80A]

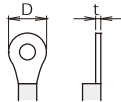
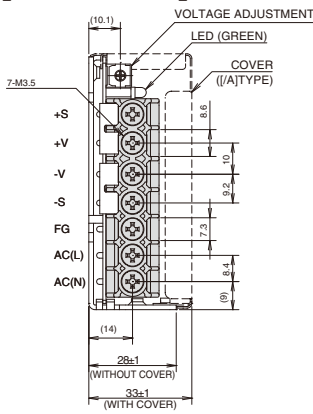

| Terminal | Recommended Solderless Terminal | | |
|----------|---------------------------------|--------|----------|
| | D(max) | t(max) | Qty(max) |
| +V / -V | 8.1mm | 0.8mm | 2 pcs |
| | | 1.0mm | 1 pcs |
| Others | 6.8mm | 0.8mm | 2 pcs |

/R (Option)
Remote ON / OFF control connector (JST)

| | |
|--------------------|--------------------------------|
| PIN HEADER | B2B-XH-AM |
| SOCKET HOUSING | XHP-2 |
| TERMINAL PINS | BXH-001T-P0.6 or SXH-001T-P0.6 |
| HAND CRIMPING TOOL | YC-110R or YRS-110 |

※ Housing and terminal pin are not attached to the product.

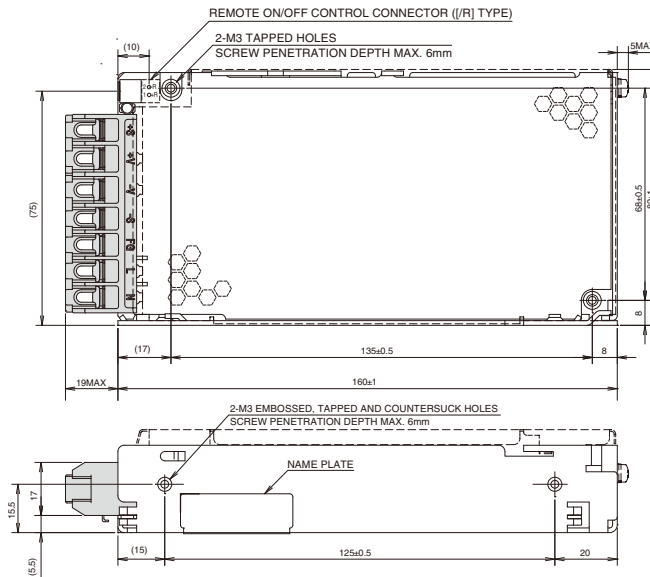

/B (OPTION)
CONNECTOR

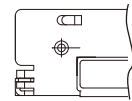
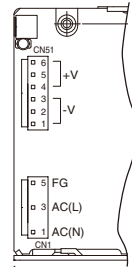

[unit: mm]

/B (Option) Use connector

| PART DESCRIPTION | PART NAME | MANUFACT | QTY |
|-----------------------------|-----------------|----------|-----|
| CONNECTOR INPUT SIDE(CN1) | B3P5-VH(LF)(SN) | JST | 1 |
| CONNECTOR OUTPUT SIDE(CN51) | B4P-VH(LF)(SN) | JST | 1 |

※ Output terminal, please use one pin per 5A below.

/B (Option) Recommended connector (it is not affixed to the product)

| PART DESCRIPTION | PART NAME | MANUFACT | QTY |
|--------------------------|------------------------------|----------|-----|
| SOCKET HOUSING (CN1) | VHR-5N | JST | 1 |
| SOCKET HOUSING (CN51) | VHR-6N | JST | 1 |
| TERMINAL PINS (CN1,CN51) | BVH-21T-P1.1 or SVH-21T-P1.1 | JST | 9 |

HAND CRIMPING TOOL: YC-160R (JST)

Output Derating

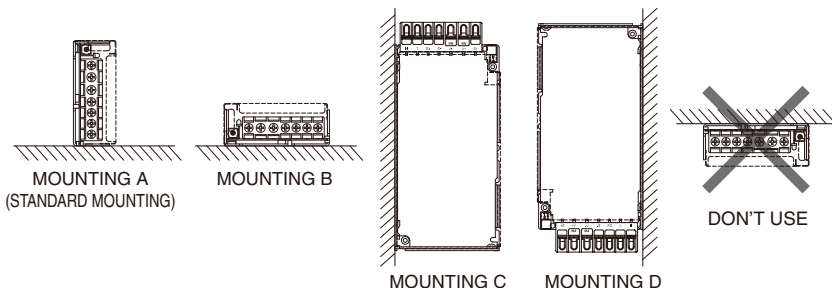
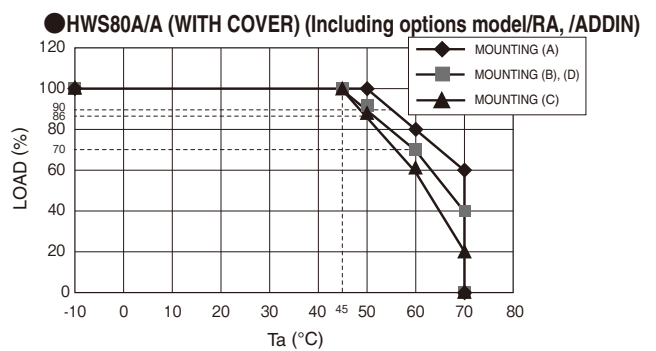
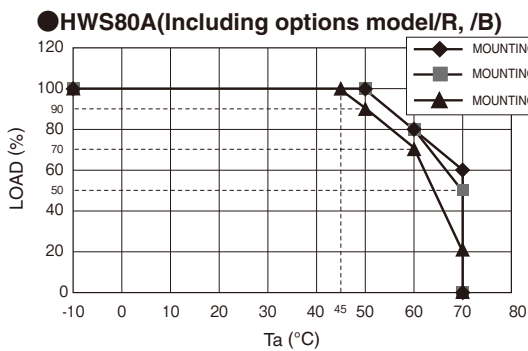

HWS100A SPECIFICATIONS (Read instruction manual carefully, before using the power supply unit.)

UNIT
PC Board

HWS-A

| ITEMS/UNITS | | MODEL | HWS100A-3 | HWS100A-5 | HWS100A-12 | HWS100A-15 | HWS100A-24 | HWS100A-48 |
|-------------|---|-------|--|-------------|-------------|-------------|-------------|-------------|
| Input | Input Voltage Range (*2) | V | AC85 - 265 (47 - 63Hz) or DC120 - 370 | | | | | |
| | Power Factor(100/200VAC) (typ) (*1) | | 0.96/0.89 | | 0.98/0.93 | | | |
| | Efficiency(100VAC) (typ) (*1) | % | 82 | 84 | 86 | 86 | 87 | 88 |
| | Efficiency(200VAC) (typ) (*1) | % | 84 | 86 | 88 | 88 | 89 | 90 |
| | Input Current (100/200VAC) (typ) (*1) | A | 0.9/0.45 | 1.3/0.65 | | | | |
| | Inrush Current (100/200VAC) (typ) (*1)(*3) | A | 14/28 (Ta = 25°C Cold Start) | | | | | |
| | Leakage Current (*9) | mA | Less than 0.5 (0.2 (typ) at 100VAC / 0.4 (typ) at 230VAC) | | | | | |
| Output | Nominal Output Voltage | VDC | 3.3 | 5 | 12 | 15 | 24 | 48 |
| | Maximum Output Current | A | 20 | 20 | 8.5 | 7 | 4.5 | 2.1 |
| | Maximum Output Power | W | 66.0 | 100.0 | 102.0 | 105.0 | 108.0 | 100.8 |
| | Maximum Line Regulation (*5) | mV | 20 | 20 | 48 | 60 | 96 | 192 |
| | Maximum Load Regulation (*6) | mV | 40 | 40 | 96 | 120 | 150 | 240 |
| | Temperature Coefficient | | Less than 0.02% /°C | | | | | |
| | Maximum Ripple & Noise(0≤Ta≤70°C) (*4) | mV | 120 | 120 | 150 | 150 | 150 | 200 |
| | Maximum Ripple & Noise(-10≤Ta<0°C) (*4) | mV | 160 | 160 | 180 | 180 | 180 | 240 |
| | Hold-up Time (typ) (*1) | ms | 20 | | | | | |
| | Output Voltage Range | VDC | 2.97 - 3.96 | 4.0 - 6.0 | 9.6 - 14.4 | 12.0 - 18.0 | 19.2 - 28.8 | 38.4 - 52.8 |
| Function | Over Current Protection (*7) | A | 21.0 - | 21.0 - | 8.92 - | 7.35 - | 4.72 - | 2.20 - |
| | Over Voltage Protection (*8) | VDC | 4.13 - 4.95 | 6.25 - 7.25 | 15.0 - 17.4 | 18.8 - 21.8 | 30.0 - 34.8 | 55.2 - 64.8 |
| | Remote Sensing | | Possible | | | | | |
| | Remote ON/OFF | | - (/R Option: Output ON in the external voltage is applied) | | | | | |
| | Parallel Operation | | - | | | | | |
| | Series Operation | | Possible | | | | | |
| | Line DIP | | Designed to meet SEMI-F47 (200VAC Line only) | | | | | |
| Environment | Operating Temperature (*10) | °C | -10 to +70 (-10 to +50°C :100%, +60°C :65%, +70°C :30%) | | | | | |
| | Storage Temperature | °C | -30 to +85 | | | | | |
| | Operating Humidity | % RH | 30 - 90 (No Condensing) | | | | | |
| | Storage Humidity | % RH | 10 - 95 (No Condensing) | | | | | |
| | Vibration | | At no operating, 10-55Hz (Sweep for 1min) 19.6m/s ² Constant, X,Y,Z 1hour each. | | | | | |
| | Shock | | Less than 196.1m/s ² | | | | | |
| | Cooling | | Convection Cooling | | | | | |
| Isolation | Withstand Voltage | | Input - FG : 2kVAC (20mA), Input - Output : 3kVAC (20mA) Output - FG : 500VAC (20mA) for 1min | | | | | |
| | Isolation Resistance | | More than 100MΩ at 25°C and 70%RH Output - FG : 500VDC | | | | | |
| Standards | Safety | | Approved by UL60950-1, CSA60950-1, EN60950-1 Designed to meet Den-an Appendix 8 at 100VAC only. With cover models only : Approved by UL508, CSA C22.2 No.107.1-01. | | | | | |
| | PFHC | | Designed to meet IEC61000-3-2 | | | | | |
| | Conducted Emission, Radiated Emission (*11) | | Designed to meet EN55011/EN55022-B, FCC-B, VCCI-B | | | | | |
| | Immunity (*11) | | Designed to meet IEC61000-6-2 IEC61000-4-2, -3, -4, -5, -6, -8, -11 | | | | | |
| Mechanical | Weight (typ) | g | 420 (With cover: 470) | | | | | |
| | Size (W x H x D) | mm | 28 x 82 x 160 (Refer to Outline Drawing) | | | | | |

(*1) At 100VAC/200VAC, Ta=25°C, nominal output voltage and maximum output power.

(*2) For cases where conformance to various safety specs (UL, CSA, EN) are required, to be described as 100 - 240VAC(50 - 60Hz).

(*3) Not applicable for the inrush current to Noise Filter for less than 0.2ms.

(*4) Measure with JEITA RC-9131B probe, Bandwidth of scope :100MHz.

(*5) 85 - 265VAC, constant load.

(*6) No load-Full load, constant input voltage.

(*7) Constant current limit and hiccup with automatic recovery.
Avoid to operate at over load or short circuit condition.

(*8) OVP circuit will shut down output, manual reset (Re power on).

(*9) Measured by the each measuring method of UL, CSA, EN and Den-an (at 60Hz), Ta=25°C.

(*10) Output Derating

- Refer to Output Derating Curve.

- Load (%) is percent of maximum output power or maximum output current, do not exceed its derating of maximum load.

(*11) The power supply is considered a component which will be installed into a final equipment.

The final equipment should be re-evaluated that it meets EMC directives.

Recommended EMC Filter

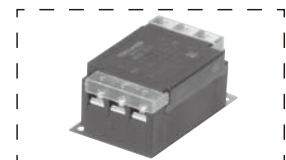

RSEN-2003D or RSEN-2003
Please refer to "TDK-Lambda
EMC Filters" catalog.

Outline Drawing

UNIT - PC Board

[HWS100A]

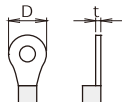
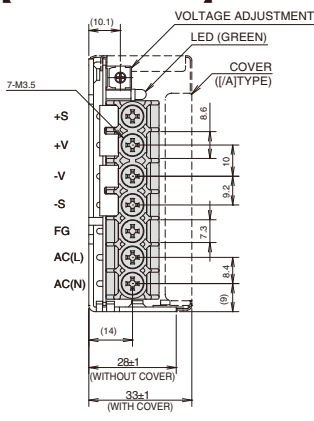

| Terminal | Recommended Solderless Terminal | | |
|----------|---------------------------------|--------|----------|
| | D(max) | t(max) | Qty(max) |
| +V / -V | 8.1mm | 0.8mm | 2 pcs |
| | | 1.0mm | 1 pcs |
| Others | 6.8mm | 0.8mm | 2 pcs |

/R (Option)
Remote ON / OFF control connector (JST)

| | |
|--------------------|--------------------------------|
| PIN HEADER | B2B-XH-AM |
| SOCKET HOUSING | XHP-2 |
| TERMINAL PINS | BXH-001T-P0.6 or SXH-001T-P0.6 |
| HAND CRIMPING TOOL | YC-110R or YRS-110 |

※ Housing and terminal pin are not attached to the product.

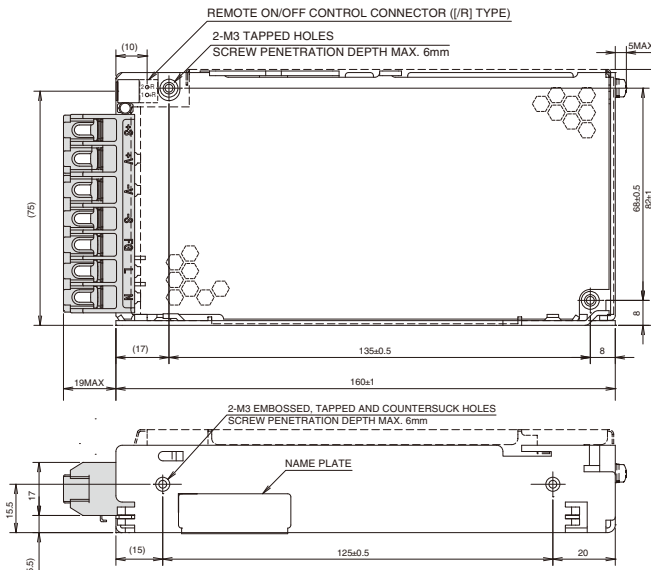

/B (OPTION) CONNECTOR

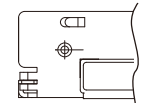
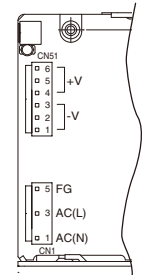

[unit: mm]

/B (Option) Use connector

| PART DESCRIPTION | PART NAME | MANUFACT | QTY |
|-----------------------------|----------------|----------|-----|
| CONNECTOR INPUT SIDE(CN1) | B3P-VH(LF)(SN) | JST | 1 |
| CONNECTOR OUTPUT SIDE(CN51) | B4P-VH(LF)(SN) | JST | 1 |

※Output terminal, please use one pin per 5A below.

/B (Option) Recommended connector (it is not affixed to the product)

| PART DESCRIPTION | PART NAME | MANUFACT | QTY |
|--------------------------|------------------------------|----------|-----|
| SOCKET HOUSING (CN1) | VHR-5N | JST | 1 |
| SOCKET HOUSING (CN51) | VHR-6N | JST | 1 |
| TERMINAL PINS (CN1,CN51) | BVH-21T-P1.1 or SVH-21T-P1.1 | JST | 9 |

HAND CRIMPING TOOL: YC-160R (JST)

HWS-A

Output Derating

●HWS100A(Including options model/R, /B)

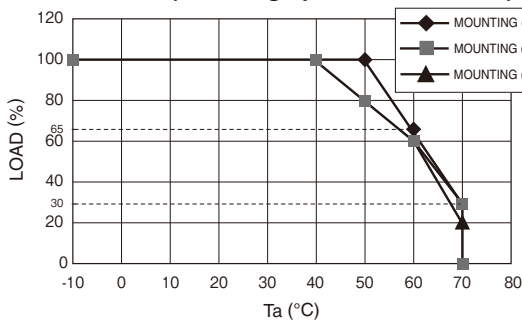

●HWS100A/A (WITH COVER) (Including options model/RA, /ADDIN)

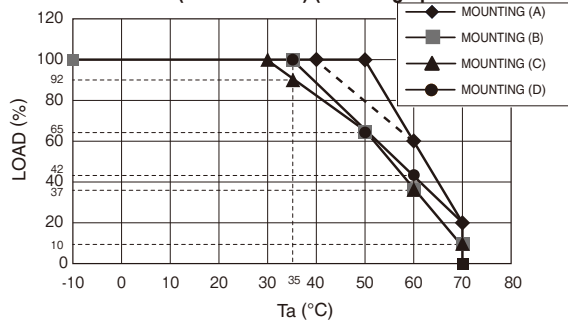

* Refer to dotted line for output derating curve, when input voltage range is "85VAC ≤ Vin < 90VAC" for the Mounting (A).

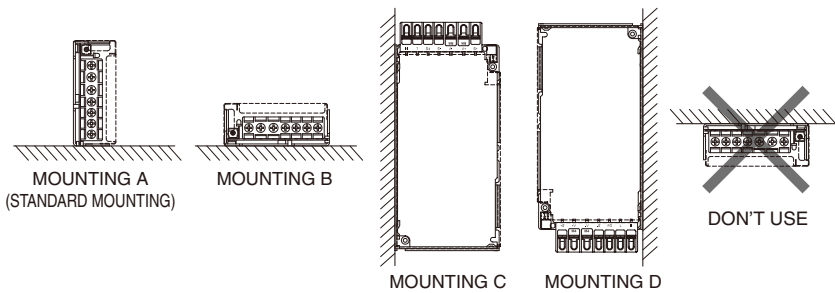

• All specifications are subject to change without notice.

HWS150A SPECIFICATIONS (Read instruction manual carefully, before using the power supply unit.)

UNIT
PC Board

| ITEMS/UNITS | | MODEL | HWS150A-3 | HWS150A-5 | HWS150A-12 | HWS150A-15 | HWS150A-24 | HWS150A-48 |
|----------------------|---|---|--|-------------|-------------|-------------|-------------|-------------|
| Input | Input Voltage Range (*2) | V | AC85 - 265 (47 - 63Hz) or DC120 - 370 | | | | | |
| | Power Factor(100/200VAC) (typ) (*1) | | 0.96/0.89 | | 0.98/0.93 | | | |
| | Efficiency(100VAC) (typ) (*1) | % | 82 | 85 | 85 | 86 | 88 | 89 |
| | Efficiency(200VAC) (typ) (*1) | % | 84 | 87 | 88 | 89 | 90 | 91 |
| | Input Current (100/200VAC) (typ) (*1) | A | 1.3/0.65 | 1.9/0.95 | | | | |
| | Inrush Current (100/200VAC) (typ) (*1)(*3) | A | 14/28 (Ta = 25°C, Cold Start) | | | | | |
| Leakage Current (*9) | mA | Less than 0.5 (0.2 (typ) at 100VAC / 0.4 (typ) at 230VAC) | | | | | | |
| Output | Nominal Output Voltage | VDC | 3.3 | 5 | 12 | 15 | 24 | 48 |
| | Maximum Output Current | A | 30 | 30 | 13 | 10 | 6.5 | 3.3 |
| | Maximum Output Power | W | 99.0 | 150.0 | 156.0 | 150.0 | 156.0 | 158.4 |
| | Maximum Line Regulation (*5) | mV | 20 | 20 | 48 | 60 | 96 | 192 |
| | Maximum Load Regulation (*6) | mV | 40 | 40 | 96 | 120 | 150 | 240 |
| | Temperature Coefficient | | Less than 0.02% /°C | | | | | |
| | Maximum Ripple & Noise(0≤Ta≤70°C) (*4) | mV | 120 | 120 | 150 | 150 | 150 | 200 |
| | Maximum Ripple & Noise(-10≤Ta<0°C) (*4) | mV | 160 | 160 | 180 | 180 | 180 | 240 |
| | Hold-up Time (typ) (*1) | ms | 20 | | | | | |
| | Output Voltage Range | VDC | 2.97 - 3.96 | 4.0 - 6.0 | 9.6 - 14.4 | 12.0 - 18.0 | 19.2 - 28.8 | 38.4 - 52.8 |
| Function | Over Current Protection (*7) | A | 31.5 — | 31.5 — | 13.6 — | 10.5 — | 6.82 — | 3.46 — |
| | Over Voltage Protection (*8) | VDC | 4.13 - 4.95 | 6.25 - 7.25 | 15.0 - 17.4 | 18.8 - 21.8 | 30.0 - 34.8 | 55.2 - 64.8 |
| | Remote Sensing | | Possible | | | | | |
| | Remote ON/OFF | | - (/R Option: Output ON in the external voltage is applied) | | | | | |
| | Parallel Operation | | - | | | | | |
| | Series Operation | | Possible | | | | | |
| | Line DIP | | Designed to meet SEMI-F47 (200VAC Line only) | | | | | |
| Environment | Operating Temperature (*10) | °C | -10 to +70 (-10 to +50°C :100%, +60°C :60%, +70°C :20%) | | | | | |
| | Storage Temperature | °C | -30 to +85 | | | | | |
| | Operating Humidity | % RH | 30 - 90 (No Condensing) | | | | | |
| | Storage Humidity | % RH | 10 - 95 (No Condensing) | | | | | |
| | Vibration | | At no operating, 10-55Hz (Sweep for 1min) 19.6m/s ² Constant, X,Y,Z 1hour each. | | | | | |
| | Shock | | Less than 196.1m/s ² | | | | | |
| | Cooling | | Convection Cooling | | | | | |
| Isolation | Withstand Voltage | | Input - FG : 2kVAC (20mA), Input - Output : 3kVAC (20mA) Output - FG : 500VAC (20mA) for 1min | | | | | |
| | Isolation Resistance | | More than 100MΩ at 25°C and 70%RH Output - FG : 500VDCC | | | | | |
| Standards | Safety | | Approved by UL60950-1, CSA60950-1, EN60950-1 Designed to meet Den-an Appendix 8 at 100VAC only. With cover models only : Approved by UL508, CSA C22.2 No.107.1-01. | | | | | |
| | PFHC | | Designed to meet IEC61000-3-2 | | | | | |
| | Conducted Emission, Radiated Emission (*11) | | Designed to meet EN55011/EN55022-B, FCC-B, VCCI-B | | | | | |
| | Immunity (*11) | | Designed to meet IEC61000-6-2 IEC61000-4-2, -3, -4, -5, -6, -8, -11 | | | | | |
| Mechanical | Weight (typ) | g | 470 (With cover: 520) | | | | | |
| | Size (W x H x D) | mm | 37 x 82 x 160 (Refer to Outline Drawing) | | | | | |

(*1) At 100VAC/200VAC, Ta=25°C, nominal output voltage and maximum output power.

(*2) For cases where conformance to various safety specs (UL, CSA, EN) are required, to be described as 100 - 240VAC(50 - 60Hz).

(*3) Not applicable for the inrush current to Noise Filter for less than 0.2ms.

(*4) Measure with JEITA RC-9131B probe, Bandwidth of scope :100MHz.

(*5) 85 - 265VAC, constant load.

(*6) No load-Full load, constant input voltage.

(*7) Constant current limit and hiccup with automatic recovery.
Avoid to operate at over load or short circuit condition.

(*8) OVP circuit will shut down output, manual reset (Re power on).

(*9) Measured by the each measuring method of UL, CSA, EN and Den-an (at 60Hz), Ta=25°C.

(*10) Output Derating

- Refer to Output Derating Curve.

- Load (%) is percent of maximum output power or maximum output current, do not exceed its derating of maximum load.

(*11) The power supply is considered a component which will be installed into a final equipment.
The final equipment should be re-evaluated that it meets EMC directives.

Recommended EMC Filter

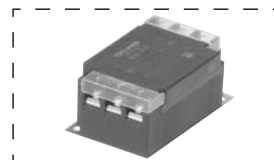

RSEN-2003D or RSEN-2003
Please refer to "TDK-Lambda
EMC Filters" catalog.

Outline Drawing

[HWS150A]

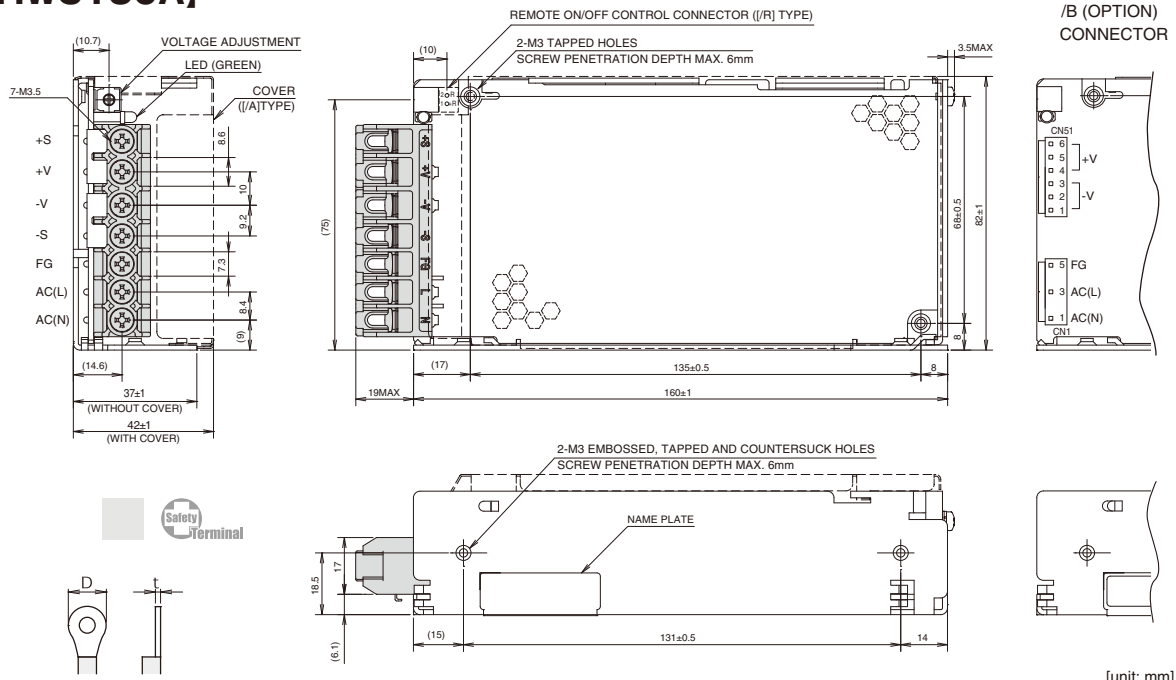

| Terminal | Recommended Solderless Terminal | | |
|----------|---------------------------------|--------|----------|
| | D(max) | t(max) | Qty(max) |
| +V / -V | 8.1mm | 0.8mm | 2 pcs |
| | | 1.0mm | 1 pcs |
| Others | 6.8mm | 0.8mm | 2 pcs |

/R (Option)

Remote ON / OFF control connector (JST)

| | |
|--------------------|--------------------------------|
| PIN HEADER | B2B-XH-AM |
| SOCKET HOUSING | XHP-2 |
| TERMINAL PINS | BXH-001T-P0.6 or SXH-001T-P0.6 |
| HAND CRIMMING TOOL | YC-110R or YRS-110 |

※ Housing and terminal pin are not attached to the product.

/B (Option) Use connector

| PART DESCRIPTION | PART NAME | MANUFACT | QTY |
|-----------------------------|-----------------|----------|-----|
| CONNECTOR INPUT SIDE(CN1) | B3P5-VH(LF)(SN) | JST | 1 |
| CONNECTOR OUTPUT SIDE(CN51) | B6P-VH(LF)(SN) | JST | 1 |

※Output terminal, please use one pin per 5A below.

/B (Option) Recommended connector (it is not affixed to the product)

| PART DESCRIPTION | PART NAME | MANUFACT | QTY |
|--------------------------|------------------------------|----------|-----|
| SOCKET HOUSING (CN1) | VHR-5N | JST | 1 |
| SOCKET HOUSING (CN51) | VHR-6N | JST | 1 |
| TERMINAL PINS (CN1,CN51) | BVH-21T-P1.1 or SVH-21T-P1.1 | JST | 9 |

HAND CRIMMING TOOL: YC-160R (JST)

Output Derating

● HWS150A(Including options model/R, /B)

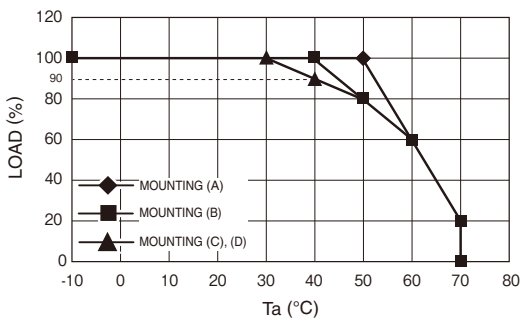

● HWS150A/A (WITH COVER) (Including options model/RA, /ADDIN)

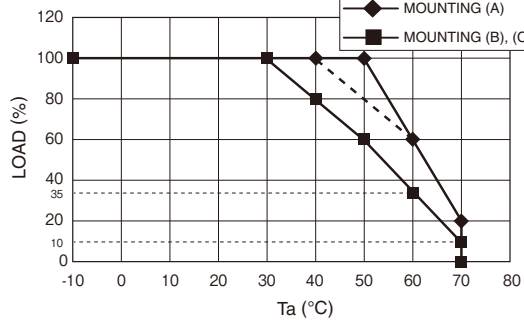

* In the case of using at the input voltage range "85 VAC ≤ Vin < 90VAC", output derating will be dashed line. (Mounting direction(A) only)

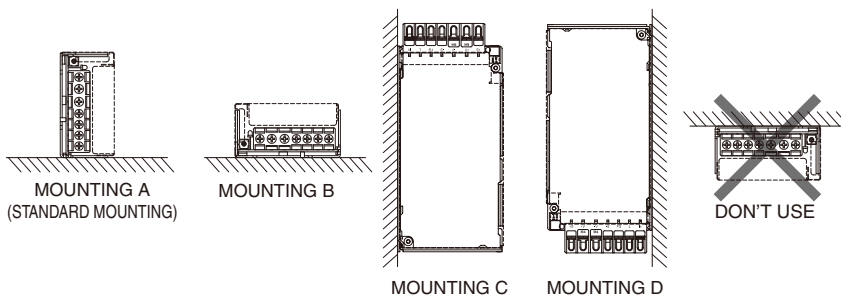

TDK·Lambda

HWS-A/HD

Single Output 30W ~ 150W

UNIT -
PC Board

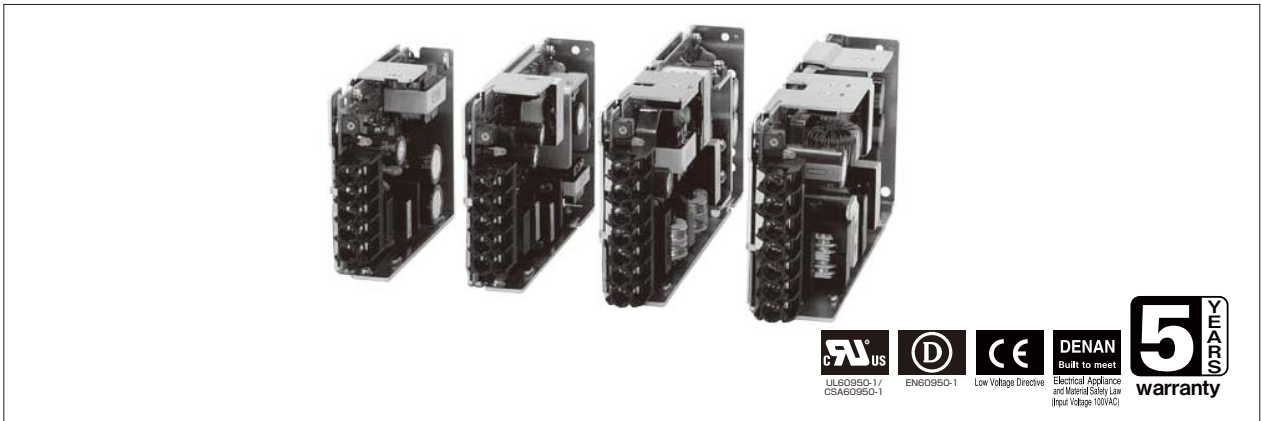

Features

- Power supply for harsh environment, heavy industry equipment, etc.
 - Guaranteed start-up at Ta=-40°C . (*1)
 - Internal PCB coating (*2)
 - Compliant to MIL-STD-810F, the standard for the products for military use (vibration resistance/shock resistance).
- Environmentally-friendly
 - Contributing to energy conservation of the customer's equipment in a further high efficiency
- Easy to use
 - All models in the same height of 82mm. Mountable in 2U-height racks without dead space.
- Safety and security
 - Reduce the maintenance frequency of your device by a long life
 - Double-sided board adopted inherited the conventional model
 - "Safety terminal" covering current flowing part secures safety for users. "No screw-dropping" design prevents from losing screws during maintenance operation.

Applications



Model naming method

[HWS30A-150A]
HWS 50A - 5 / HD

Series name Output power

HD : Without cover for harsh environment
 HDA : With cover for harsh environment

Nominal Output Voltage
 ex. 3 : 3.3V, 5 : 5V, 48 : 48V

HWS-A/HD

Conformity to RoHS Directive

This means that, in conformity with EU Directive 2011/65/EU, lead, cadmium, mercury, hexavalent chromium, and specific bromine-based flame retardants, PBB and PBDE, have not been used, except for exempted applications.

Product Line up

| Output Voltage | 30W | | 50W | | 100W | | 150W | |
|----------------|----------------|--------------|----------------|--------------|----------------|---------------|----------------|---------------|
| | Output Current | MODEL | Output Current | MODEL | Output Current | MODEL | Output Current | MODEL |
| 3.3V | 6A | HWS30A-3/HD | 10A | HWS50A-3/HD | 20A | HWS100A-3/HD | 30A | HWS150A-3/HD |
| 5V | 6A | HWS30A-5/HD | 10A | HWS50A-5/HD | 20A | HWS100A-5/HD | 30A | HWS150A-5/HD |
| 12V | 2.5A | HWS30A-12/HD | 4.3A | HWS50A-12/HD | 8.5A | HWS100A-12/HD | 13A | HWS150A-12/HD |
| 15V | 2A | HWS30A-15/HD | 3.5A | HWS50A-15/HD | 7A | HWS100A-15/HD | 10A | HWS150A-15/HD |
| 24V | 1.3A | HWS30A-24/HD | 2.2A | HWS50A-24/HD | 4.5A | HWS100A-24/HD | 6.5A | HWS150A-24/HD |
| 48V | 0.65A | HWS30A-48/HD | 1.1A | HWS50A-48/HD | 2.1A | HWS100A-48/HD | 3.3A | HWS150A-48/HD |

(*1) The power supply might not start up according to the input voltage and the load condition at the low temperature (Ta: -40 to -10°C). For details, please refer to "Start-up condition at the low temperature".

(*2) For resistance against humidity, dust-related improvement-resistant, board both sides are coated. But it may not be completely possible for the effect because there is the point that is not coated partly. Please refer for the details to us

HWS30A/HD SPECIFICATIONS (Read instruction manual carefully, before using the power supply unit.)

UNIT
PC Board

| | | MODEL | HWS30A -3/HD | HWS30A -5/HD | HWS30A -12/HD | HWS30A -15/HD | HWS30A -24/HD | HWS30A -48/HD | |
|----------------------|---|---|--|-----------------|------------------|------------------|------------------|------------------|--|
| Input | Input Voltage Range (*2) | V | AC85 - 265 (47 - 63Hz) or DC120 - 370 | | | | | | |
| | Efficiency(100VAC) (typ) (*1) | % | 75 | 80 | 84 | 85 | 86 | 86 | |
| | Efficiency(200VAC) (typ) (*1) | % | 77 | 82 | 86 | 87 | 88 | 87 | |
| | Input Current (100/200VAC) (typ) (*1) | A | 0.5/0.3 | 0.65/0.4 | | | | | |
| | Inrush Current (100/200VAC) (typ) (*1)(*3) | A | 14/28 (Ta = 25°C, Cold Start) | | | | | | |
| Leakage Current (*9) | mA | Less than 0.5 (0.2 (typ) at 100VAC / 0.4 (typ) at 230VAC) | | | | | | | |
| Output | Nominal Output Voltage | VDC | 3.3 | 5 | 12 | 15 | 24 | 48 | |
| | Maximum Output Current | A | 6 | 6 | 2.5 | 2 | 1.3 | 0.65 | |
| | Maximum Output Power | W | 20.0 | 30.0 | 30.0 | 30.0 | 31.2 | 31.2 | |
| | Maximum Line Regulation (*5) | mV | 20 | 20 | 48 | 60 | 96 | 192 | |
| | Maximum Load Regulation (*6) | mV | 40 | 40 | 96 | 120 | 150 | 240 | |
| | Temperature Coefficient | | Less than 0.02% /°C | | | | | | |
| | Maximum Ripple & Noise(0 ≤ Ta ≤ 70°C) (*4) | mV | 120 | 120 | 150 | 150 | 150 | 200 | |
| | Maximum Ripple & Noise(-10 ≤ Ta < 0°C) (*4) | mV | 160 | 160 | 180 | 180 | 180 | 240 | |
| | Hold-up Time (typ) (*1) | ms | 20 | | | | | | |
| | Output Voltage Range | VDC | 2.97 - 3.96 | 4.0 - 6.0 | 9.6 - 14.4 | 12.0 - 18.0 | 19.2 - 28.8 | 38.4 - 52.8 | |
| Function | Over Current Protection (*7) | A | 6.3 — | 6.3 — | 2.62 — | 2.1 — | 1.36 — | 0.68 — | |
| | Over Voltage Protection (*8) | VDC | 4.13 - 4.95 | 6.25 - 7.25 | 15.0 - 17.4 | 18.8 - 21.8 | 30.0 - 34.8 | 55.2 - 64.8 | |
| | Remote Sensing | | - | | | | | | |
| | Parallel Operation | | - | | | | | | |
| | Series Operation | | Possible | | | | | | |
| Line DIP | | Designed to meet SEMI-F47 (200VAC Line only) | | | | | | | |
| Environment | Operating Temperature (*10) | °C | -10 to +71 (-10 to +50°C :100%, +60°C :60%, +71°C :40%), , start up -40 to -10 | | | | | | |
| | Storage Temperature | °C | -40 to +85 | | | | | | |
| | Operating Humidity | % RH | 30 - 90 (No Condensing) | | | | | | |
| | Storage Humidity | % RH | 10 - 95 (No Condensing) | | | | | | |
| | Vibration (*11) | | At no operating, 10-55Hz (Sweep for 1min) 19.6m/s ² Constant, X,Y,Z 1hour each. Designed to meet MIL-STD-810F 514.5 Category 4, 10 | | | | | | |
| | Shock | | Less than 196.1m/s ² Designed to meet MIL-STD-810F 516.5 Procedure I, VI | | | | | | |
| | Cooling | | Convection Cooling | | | | | | |
| Isolation | Withstand Voltage | | Input - FG : 2kVAC (20mA), Input - Output : 3kVAC (20mA) Output - FG : 500VAC (20mA) for 1min | | | | | | |
| | Isolation Resistance | | More than 100MΩ at 25°C and 70%RH Output - FG : 500VDC | | | | | | |
| Standards | Safety | | Approved by UL60950-1, CSA60950-1, EN60950-1 Designed to meet Den-an Appendix 8 at 100VAC only. | | | | | | |
| | PFHC | | Designed to meet IEC61000-3-2 | | | | | | |
| | Conducted Emission, Radiated Emission (*12) | | Designed to meet EN55011/EN55022-B, FCC-B, VCCI-B | | | | | | |
| | Immunity (*12) | | Designed to meet IEC61000-6-2 IEC61000-4-2, -3, -4, -5, -6, -8, -11 | | | | | | |
| Mechanical | Weight (typ) | g | 200 | | | | | | |
| | Size (W x H x D) | mm | 26.5 x 82 x 95 (Refer to Outline Drawing) | | | | | | |

(*1) At 100VAC/200VAC, Ta=25°C, nominal output voltage and maximum output power.

(*2) For cases where conformance to various safety specs (UL, CSA, EN) are required, to be described as 100 - 240VAC(50 - 60Hz).

(*3) Not applicable for the inrush current to Noise Filter for less than 0.2ms.

(*4) Measure with JEITA RC-9131B probe, Bandwidth of scope :100MHz.

For start up at low ambient temperature and low input voltage, output ripple noise might not meet specification. However, specification can be met after one second.

(*5) 85 - 265VAC, constant load.

(*6) No load-Full load, constant input voltage.

(*7) Hiccup with automatic recovery. Avoid to operate at over load or short circuit condition.

(*8) OVP circuit will shut down output, manual reset (Re power on).

(*9) Measured by the each measuring method of UL, CSA, EN and Den-an (at 60Hz), Ta=25°C.

(*10) Output Derating

- Refer to Output Derating Curve.

- Load (%) is percent of maximum output power or maximum output current, do not exceed its derating of maximum load.

- For conditions of start up at -40°C to -10°C, refer to Start-up condition at low temperature.

(*11) Category 4 exposure levels : Track transportation over U.S. highways, Composite two-wheeled trailer.

(*12) The power supply is considered a component which will be installed into a final equipment.

The final equipment should be re-evaluated that it meets EMC directives.

Recommended EMC Filter

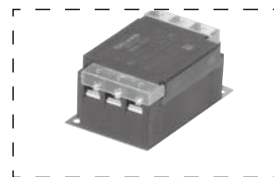

RSEN-2003D or RSEN-2003

Please refer to "TDK-Lambda EMC Filters" catalog.

Outline Drawing

UNIT - PC Board

[HWS30A/HD]

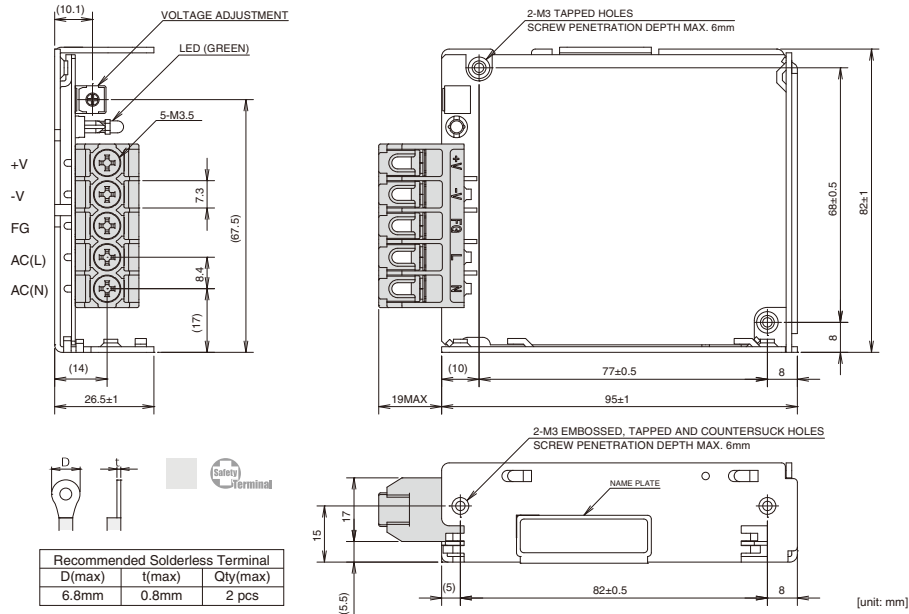

HWS-A/HD

Output Derating

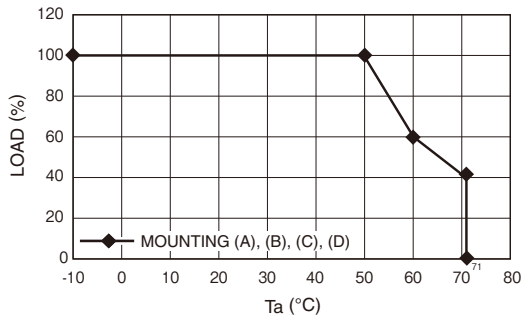

| Ta (°C) | LOAD (%) |
|------------|--------------------------|
| | MOUNTING (A),(B),(C),(D) |
| -10 to +50 | 100 |
| 60 | 60 |
| 71 | 40 |

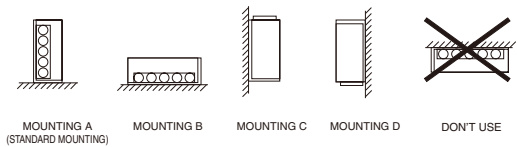

Start-up condition at low temperature

● DERATING TO START UP AT Ta : -40 to -10°C

| Input Voltage (VAC) | LOAD(%) | |
|---------------------|------------------|---|
| | Normal start up. | Stable output after 1 min from start up |
| 85 ≤ Vin < 100 | 30 | 100 |
| 100 ≤ Vin < 132 | 50 | 100 |
| 132 ≤ Vin ≤ 265 | 100 | 100 |

=NOTES=

- * At Ta : -40 to -10° C.
- * Input voltage : Not gradual start up.
- * Do not use the load that is constant current mode.
- * Avoid forced air cooling. It is assumed that inside of power supply is heated by self-heating within 1 minutes.
- * No condensing.
- * Pay attention to above items before using the unit. Incorrect usage could lead to unstable output voltage.

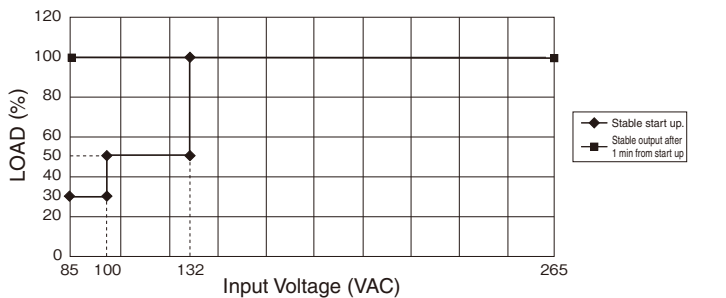

HWS50A/HD SPECIFICATIONS (Read instruction manual carefully, before using the power supply unit.)

UNIT
PC Board

| ITEMS/UNITS | | MODEL | HWS50A -3/HD | HWS50A -5/HD | HWS50A -12/HD | HWS50A -15/HD | HWS50A -24/HD | HWS50A -48/HD |
|----------------------|---|---|--|-----------------|------------------|------------------|------------------|------------------|
| Input | Input Voltage Range (*2) | V | AC85 - 265 (47 - 63Hz) or DC120 - 370 | | | | | |
| | Power Factor(100/200VAC) (typ) (*1) | | 0.96/0.85 | 0.97/0.91 | | | | |
| | Efficiency(100VAC) (typ) (*1) | % | 76 | 82 | 83 | 83 | 84 | 84 |
| | Efficiency(200VAC) (typ) (*1) | % | 78 | 84 | 85 | 86 | 87 | 86 |
| | Input Current (100/200VAC) (typ) (*1) | A | 0.45/0.25 | 0.65/0.35 | | | | |
| | Inrush Current (100/200VAC) (typ) (*1)(*3) | A | 14/28 (Ta = 25°C , Cold Start) | | | | | |
| Leakage Current (*9) | mA | Less than 0.5 (0.2 (typ) at 100VAC / 0.4 (typ) at 230VAC) | | | | | | |
| Output | Nominal Output Voltage | VDC | 3.3 | 5 | 12 | 15 | 24 | 48 |
| | Maximum Output Current | A | 10 | 10 | 4.3 | 3.5 | 2.2 | 1.1 |
| | Maximum Output Power | W | 33.0 | 50.0 | 51.6 | 52.5 | 52.8 | 52.8 |
| | Maximum Line Regulation (*5) | mV | 20 | 20 | 48 | 60 | 96 | 192 |
| | Maximum Load Regulation (*6) | mV | 40 | 40 | 96 | 120 | 150 | 240 |
| | Temperature Coefficient | | Less than 0.02% /°C | | | | | |
| | Maximum Ripple & Noise(0 ≤ Ta ≤ 70°C) (*4) | mV | 120 | 120 | 150 | 150 | 150 | 200 |
| | Maximum Ripple & Noise(-10 ≤ Ta < 0°C) (*4) | mV | 160 | 160 | 180 | 180 | 180 | 240 |
| | Hold-up Time (typ) (*1) | ms | 20 | | | | | |
| | Output Voltage Range | VDC | 2.97 - 3.96 | 4.0 - 6.0 | 9.6 - 14.4 | 12.0 - 18.0 | 19.2 - 28.8 | 38.4 - 52.8 |
| Function | Over Current Protection (*7) | A | 10.5 — | 10.5 — | 4.51 — | 3.67 — | 2.31 — | 1.15 — |
| | Over Voltage Protection (*8) | VDC | 4.13 - 4.95 | 6.25 - 7.25 | 15.0 - 17.4 | 18.8 - 21.8 | 30.0 - 34.8 | 55.2 - 64.8 |
| | Remote Sensing | | - | | | | | |
| | Parallel Operation | | - | | | | | |
| | Series Operation | | Possible | | | | | |
| | Line DIP | | Designed to meet SEMI-F47 (200VAC Line only) | | | | | |
| Environment | Operating Temperature (*10) | °C | -10 to +71 (-10 to +50°C :100%, +60°C :70%, +71°C :40%), , start up -40 to -10 | | | | | |
| | Storage Temperature | °C | -40 to +85 | | | | | |
| | Operating Humidity | % RH | 30 - 90 (No Condensing) | | | | | |
| | Storage Humidity | % RH | 10 - 95 (No Condensing) | | | | | |
| | Vibration (*11) | | At no operating, 10-55Hz (Sweep for 1min) 19.6m/s ² Constant, X,Y,Z 1hour each. Designed to meet MIL-STD-810F 514.5 Category 4, 10 | | | | | |
| | Shock | | Less than 196.1m/s ² Designed to meet MIL-STD-810F 516.5 Procedure I, VI | | | | | |
| | Cooling | | Convection Cooling | | | | | |
| Isolation | Withstand Voltage | | Input - FG : 2kVAC (20mA), Input - Output : 3kVAC (20mA) Output - FG : 500VAC (20mA) for 1min | | | | | |
| | Isolation Resistance | | More than 100MΩ at 25°C and 70%RH Output - FG : 500VDC | | | | | |
| Standards | Safety | | Approved by UL60950-1, CSA60950-1, EN60950-1 Designed to meet Den-an Appendix 8 at 100VAC only. | | | | | |
| | PFHC | | Designed to meet IEC61000-3-2 | | | | | |
| | Conducted Emission, Radiated Emission (*12) | | Designed to meet EN55011/EN55022-B, FCC-B, VCCI-B | | | | | |
| | Immunity (*12) | | Designed to meet IEC61000-6-2 IEC61000-4-2, -3, -4, -5, -6, -8, -11 | | | | | |
| Mechanical | Weight (typ) | g | 260 | | | | | |
| | Size (W x H x D) | mm | 26.5 x 82 x 120 (Refer to Outline Drawing) | | | | | |

- (*1) At 100VAC/200VAC, Ta=25°C , nominal output voltage and maximum output power.
- (*2) For cases where conformance to various safety specs (UL, CSA, EN) are required, to be described as 100 - 240VAC(50 - 60Hz).
- (*3) Not applicable for the inrush current to Noise Filter for less than 0.2ms.
- (*4) Measure with JEITA RC-9131B probe, Bandwidth of scope :100MHz.
- (*5) 85 - 265VAC, constant load.
- (*6) No load-Full load, constant input voltage.
- (*7) Hiccup with automatic recovery. Avoid to operate at over load or short circuit condition.
- (*8) OVP circuit will shut down output, manual reset (Re power on).
- (*9) Measured by the each measuring method of UL, CSA, EN and Den-an (at 60Hz), Ta=25°C .
- (*10) Output Derating
 - Refer to Output Derating Curve.
 - Load (%) is percent of maximum output power or maximum output current, do not exceed its derating of maximum load.
 - For conditions of start up at -40°C to -10°C , refer to Start-up condition at low temperature.
- (*11) Category 4 exposure levels : Track transportation over U.S. highways, Composite two-wheeled trailer.
- (*12) The power supply is considered a component which will be installed into a final equipment.
The final equipment should be re-evaluated that it meets EMC directives.

Recommended EMC Filter

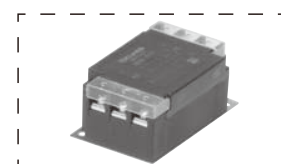

RSEN-2003D or RSEN-2003
Please refer to "TDK-Lambda
EMC Filters" catalog.

Outline Drawing

UNIT - PC Board

[HWS50A/HD]

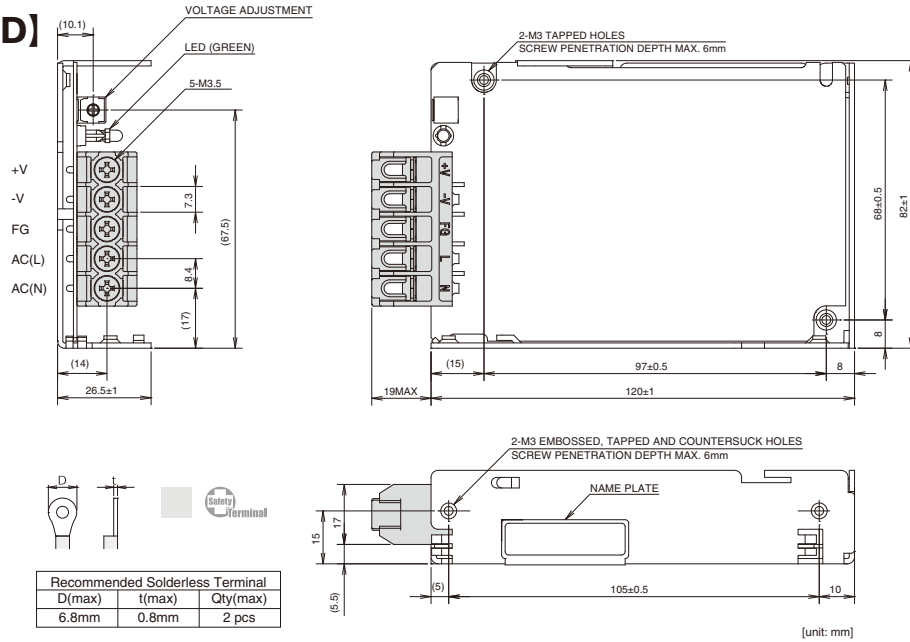

HWS-A/HD

Output Derating

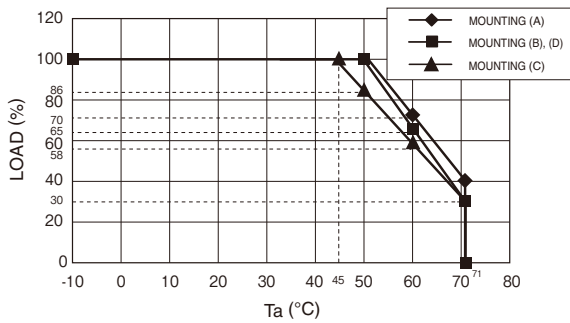

| Ta (°C) | LOAD (%) | | |
|------------|--------------|------------------|--------------|
| | MOUNTING (A) | MOUNTING (B),(D) | MOUNTING (C) |
| -10 to +45 | 100 | 100 | 100 |
| 50 | 100 | 100 | 86 |
| 60 | 70 | 65 | 58 |
| 71 | 40 | 30 | 30 |

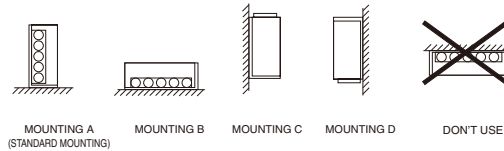

Start-up condition at low temperature

●DERATING TO START UP AT Ta : -40 to -10°C

| Input Voltage (VAC) | LOAD(%) | |
|---------------------|------------------|---|
| | Normal start up. | Stable output after 1 min from start up |
| 85 ≤ Vin < 95 | 90 | 100 |
| 95 ≤ Vin ≤ 265 | 100 | 100 |

=NOTES=

- * At Ta : -40 to -10° C.
- * Input voltage : Not gradual start up.
- * Do not use the load that is constant current mode.
- * Avoid forced air cooling. It is assumed that inside of power supply is heated by self-heating within 1 minutes.
- * No condensing.
- * Pay attention to above items before using the unit. Incorrect usage could lead to unstable output voltage.

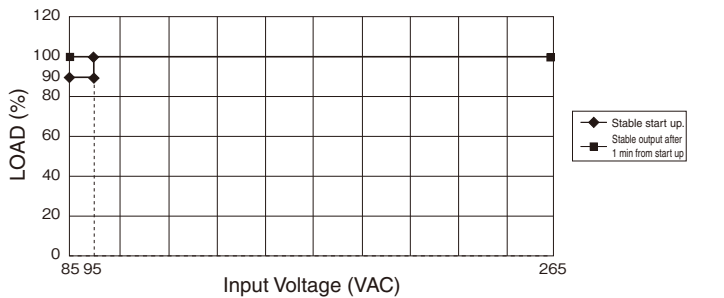

HWS100A/HD SPECIFICATIONS (Read instruction manual carefully, before using the power supply unit.)

UNIT
PC Board

| ITEMS/UNITS | | MODEL | HWS100A -3/HD | HWS100A -5/HD | HWS100A -12/HD | HWS100A -15/HD | HWS100A -24/HD | HWS100A -48/HD |
|------------------------------|---|------------------------------|--|------------------|-------------------|-------------------|-------------------|-------------------|
| Input | Input Voltage Range (*2) | V | AC85 - 265 (47 - 63Hz) or DC120 - 370 | | | | | |
| | Power Factor(100/200VAC) (typ) (*1) | | 0.96/0.89 | | 0.98/0.93 | | | |
| | Efficiency(100VAC) (typ) (*1) | % | 82 | 84 | 86 | 86 | 87 | 88 |
| | Efficiency(200VAC) (typ) (*1) | % | 84 | 86 | 88 | 88 | 89 | 90 |
| | Input Current (100/200VAC) (typ) (*1) | A | 0.9/0.45 | 1.3/0.65 | | | | |
| | Inrush Current (100/200VAC) (typ) (*1)(*3) | A | 14/28 (Ta = 25°C Cold Start) | | | | | |
| | Leakage Current (*9) | mA | Less than 0.5 (0.2 (typ) at 100VAC / 0.4 (typ) at 230VAC) | | | | | |
| Output | Nominal Output Voltage | VDC | 3.3 | 5 | 12 | 15 | 24 | 48 |
| | Maximum Output Current | A | 20 | 20 | 8.5 | 7 | 4.5 | 2.1 |
| | Maximum Output Power | W | 66.0 | 100.0 | 102.0 | 105.0 | 108.0 | 100.8 |
| | Maximum Line Regulation (*5) | mV | 20 | 20 | 48 | 60 | 96 | 192 |
| | Maximum Load Regulation (*6) | mV | 40 | 40 | 96 | 120 | 150 | 240 |
| | Temperature Coefficient | | Less than 0.02% /°C | | | | | |
| | Maximum Ripple & Noise(0 ≤ Ta ≤ 70°C) (*4) | mV | 120 | 120 | 150 | 150 | 150 | 200 |
| | Maximum Ripple & Noise(-10 ≤ Ta < 0°C) (*4) | mV | 160 | 160 | 180 | 180 | 180 | 240 |
| | Hold-up Time (typ) (*1) | ms | 20 | | | | | |
| | Output Voltage Range | VDC | 2.97 - 3.96 | 4.0 - 6.0 | 9.6 - 14.4 | 12.0 - 18.0 | 19.2 - 28.8 | 38.4 - 52.8 |
| | Function | Over Current Protection (*7) | A | 21.0 - | 21.0 - | 8.92 - | 7.35 - | 4.72 - |
| Over Voltage Protection (*8) | | VDC | 4.13 - 4.95 | 6.25 - 7.25 | 15.0 - 17.4 | 18.8 - 21.8 | 30.0 - 34.8 | 55.2 - 64.8 |
| Remote Sensing | | | Possible | | | | | |
| Parallel Operation | | | - | | | | | |
| Series Operation | | | Possible | | | | | |
| Line DIP | | | Designed to meet SEMI-F47 (200VAC Line only) | | | | | |
| Environment | Operating Temperature (*10) | °C | -10 to +71 (-10 to +50°C :100%, +60°C :65%, +71°C :30%), , start up -40 to -10 | | | | | |
| | Storage Temperature | °C | -40 to +85 | | | | | |
| | Operating Humidity | % RH | 30 - 90 (No Condensing) | | | | | |
| | Storage Humidity | % RH | 10 - 95 (No Condensing) | | | | | |
| | Vibration (*11) | | At no operating, 10-55Hz (Sweep for 1min) 19.6m/s ² Constant, X,Y,Z 1hour each. Designed to meet MIL-STD-810F 514.5 Category 4, 10 | | | | | |
| | Shock | | Less than 196.1m/s ² Designed to meet MIL-STD-810F 516.5 Procedure I, VI | | | | | |
| | Cooling | | Convection Cooling | | | | | |
| Isolation | Withstand Voltage | | Input - FG : 2kVAC (20mA), Input - Output : 3kVAC (20mA) Output - FG : 500VAC (20mA) for 1min | | | | | |
| | Isolation Resistance | | More than 100MΩ at 25°C and 70%RH Output - FG : 500VDC | | | | | |
| Standards | Safety | | Approved by UL60950-1, CSA60950-1, EN60950-1 Designed to meet Den-an Appendix 8 at 100VAC only. | | | | | |
| | PFHC | | Designed to meet IEC61000-3-2 | | | | | |
| | Conducted Emission, Radiated Emission (*12) | | Designed to meet EN55011/EN55022-B, FCC-B, VCCI-B | | | | | |
| | Immunity (*12) | | Designed to meet IEC61000-6-2 IEC61000-4-2, -3, -4, -5, -6, -8, -11 | | | | | |
| Mechanical | Weight (typ) | g | 420 | | | | | |
| | Size (W x H x D) | mm | 28 x 82 x 160 (Refer to Outline Drawing) | | | | | |

(*1) At 100VAC/200VAC, Ta=25°C, nominal output voltage and maximum output power.

(*2) For cases where conformance to various safety specs (UL, CSA, EN) are required, to be described as 100 - 240VAC(50 - 60Hz).

(*3) Not applicable for the inrush current to Noise Filter for less than 0.2ms.

(*4) Measure with JEITA RC-9131B probe, Bandwidth of scope :100MHz.

(*5) 85 - 265VAC, constant load.

(*6) No load-Full load, constant input voltage.

(*7) Constant current limit and hiccup with automatic recovery.
Avoid to operate at over load or short circuit condition.

(*8) OVP circuit will shut down output, manual reset (Re power on).

(*9) Measured by the each measuring method of UL, CSA, EN and Den-an (at 60Hz), Ta=25°C.

(*10) Output Derating

- Refer to Output Derating Curve.

- Load (%) is percent of maximum output power or maximum output current, whichever is greater.

- As for other mountings, refer to derating curve.

- For conditions of start up at -40°C to -10°C, refer to Start-up condition at low temperature.

(*11) Category 4 exposure levels : Track transportation over U.S. highways, Composite two-wheeled trailer.

(*12) The power supply is considered a component which will be installed into a final equipment.
The final equipment should be re-evaluated that it meets EMC directives.

Recommended EMC Filter

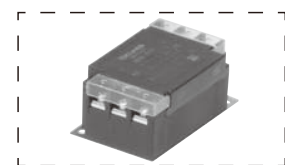

RSEN-2003D or RSEN-2003
Please refer to "TDK-Lambda
EMC Filters" catalog.

Outline Drawing

UNIT - PC Board

[HWS100A/HD]

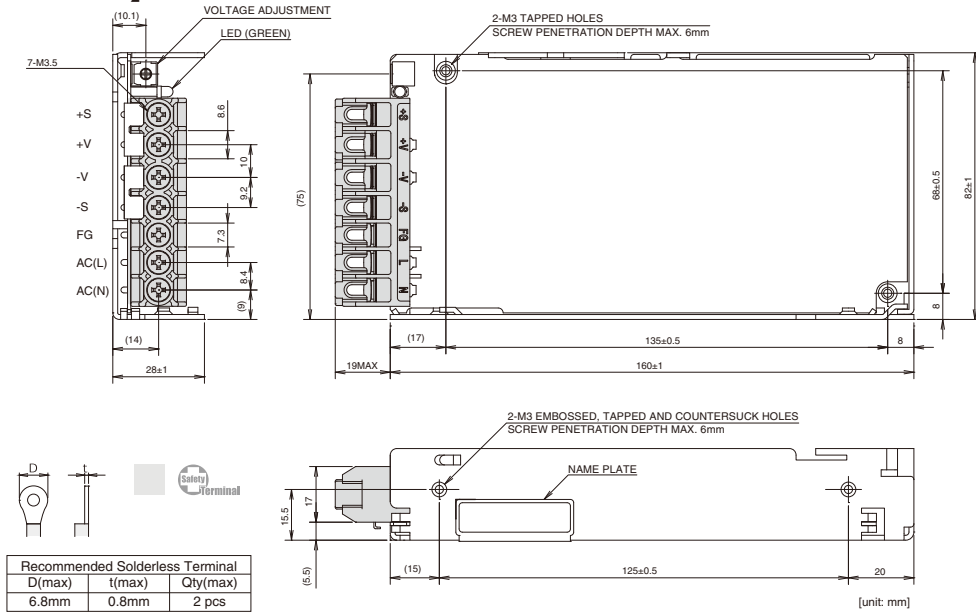

HWS-A/HD

Output Derating

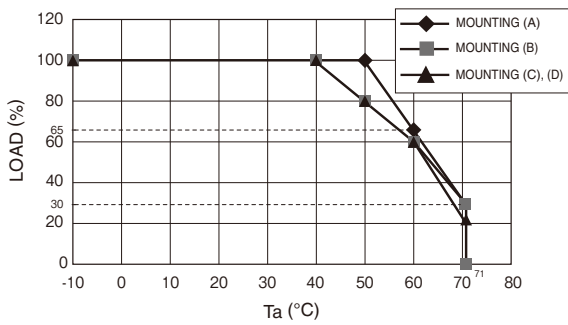

| Ta (°C) | LOAD (%) | | |
|------------|--------------|--------------|------------------|
| | MOUNTING (A) | MOUNTING (B) | MOUNTING (C),(D) |
| -10 to +40 | 100 | 100 | 100 |
| 50 | 100 | 80 | 80 |
| 60 | 65 | 60 | 60 |
| 71 | 30 | 30 | 20 |

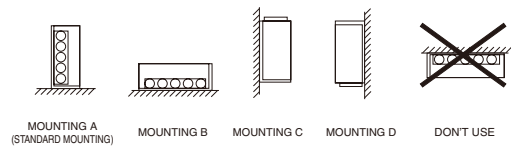

Start-up condition at low temperature

DERATING TO START UP AT Ta : -40 to -10°C

| Input Voltage (VAC) | LOAD(%) | |
|---------------------|------------------|---|
| | Normal start up. | Stable output after 1 min from start up |
| 85 ≤ Vin < 90 | 90 | 100 |
| 90 ≤ Vin ≤ 265 | 100 | 100 |

=NOTES=

- * At Ta : -40 to -10° C.
- * Input voltage : Not gradual start up.
- * Do not use the load that is constant current mode.
- * Avoid forced air cooling. It is assumed that inside of power supply is heated by self-heating within 1 minutes.
- * No condensing.
- * Pay attention to above items before using the unit. Incorrect usage could lead to unstable output voltage.

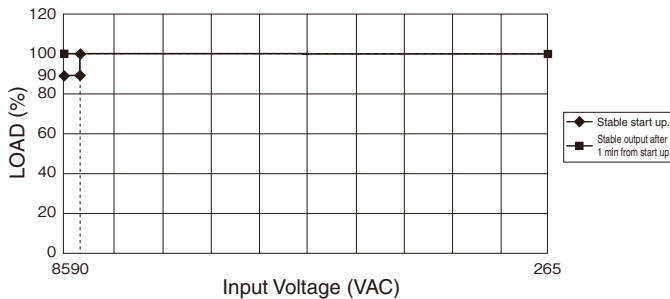

HWS150A/HD SPECIFICATIONS (Read instruction manual carefully, before using the power supply unit.)

UNIT
PC Board

| ITEMS/UNITS | | MODEL | HWS150A -3/HD | HWS150A -5/HD | HWS150A -12/HD | HWS150A -15/HD | HWS150A -24/HD | HWS150A -48/HD | |
|-----------------|---|----------|--|-------------------------------|-------------------|-------------------|-------------------|-------------------|-------------|
| Input | Input Voltage Range (*2) | V | AC85 - 265 (47 - 63Hz) or DC120 - 370 | | | | | | |
| | Power Factor(100/200VAC) (typ) | (*1) | 0.96/0.89 | | 0.98/0.93 | | | | |
| | Efficiency(100VAC) (typ) | (*1) | % | 82 | 85 | 85 | 86 | 88 | 89 |
| | Efficiency(200VAC) (typ) | (*1) | % | 84 | 87 | 88 | 89 | 90 | 91 |
| | Input Current (100/200VAC) (typ) | (*1) | A | 1.3/0.65 | | 1.9/0.95 | | | |
| | Inrush Current (100/200VAC) (typ) | (*1)(*3) | A | 14/28 (Ta = 25°C, Cold Start) | | | | | |
| Leakage Current | (*9) | mA | Less than 0.5 (0.2 (typ) at 100VAC / 0.4 (typ) at 230VAC) | | | | | | |
| Output | Nominal Output Voltage | VDC | 3.3 | 5 | 12 | 15 | 24 | 48 | |
| | Maximum Output Current | A | 30 | 30 | 13 | 10 | 6.5 | 3.3 | |
| | Maximum Output Power | W | 99.0 | 150.0 | 156.0 | 150.0 | 156.0 | 158.4 | |
| | Maximum Line Regulation | (*5) | mV | 20 | 20 | 48 | 60 | 96 | 192 |
| | Maximum Load Regulation | (*6) | mV | 40 | 40 | 96 | 120 | 150 | 240 |
| | Temperature Coefficient | | Less than 0.02% /°C | | | | | | |
| | Maximum Ripple & Noise(0 ≤ Ta ≤ 70°C) (*4) | mV | 120 | 120 | 150 | 150 | 150 | 200 | |
| | Maximum Ripple & Noise(-10 ≤ Ta < 0°C) (*4) | mV | 160 | 160 | 180 | 180 | 180 | 240 | |
| | Hold-up Time (typ) | (*1) | ms | 20 | | | | | |
| | Output Voltage Range | VDC | 2.97 - 3.96 | 4.0 - 6.0 | 9.6 - 14.4 | 12.0 - 18.0 | 19.2 - 28.8 | 38.4 - 52.8 | |
| Function | Over Current Protection | (*7) | A | 31.5 — | 31.5 — | 13.6 — | 10.5 — | 6.82 — | 3.46 — |
| | Over Voltage Protection | (*8) | VDC | 4.13 - 4.95 | 6.25 - 7.25 | 15.0 - 17.4 | 18.8 - 21.8 | 30.0 - 34.8 | 55.2 - 64.8 |
| | Remote Sensing | | Possible | | | | | | |
| | Parallel Operation | | - | | | | | | |
| | Series Operation | | Possible | | | | | | |
| | Line DIP | | Designed to meet SEMI-F47 (200VAC Line only) | | | | | | |
| Environment | Operating Temperature | (*10) | °C -10 to +71 (-10 to +50°C :100%, +60°C :60%, +71°C :20%), start up -40 to -10 | | | | | | |
| | Storage Temperature | | °C -40 to +85 | | | | | | |
| | Operating Humidity | | % RH 30 - 90 (No Condensing) | | | | | | |
| | Storage Humidity | | % RH 10 - 95 (No Condensing) | | | | | | |
| | Vibration | (*11) | At no operating, 10-55Hz (Sweep for 1min) 19.6m/s ² Constant, X,Y,Z 1hour each. Designed to meet MIL-STD-810F 514.5 Category 4, 10 | | | | | | |
| | Shock | | Less than 196.1m/s ² Designed to meet MIL-STD-810F 516.5 Procedure I, VI | | | | | | |
| | Cooling | | Convection Cooling | | | | | | |
| Isolation | Withstand Voltage | | Input - FG : 2kVAC (20mA), Input - Output : 3kVAC (20mA) Output - FG : 500VAC (20mA) for 1min | | | | | | |
| | Isolation Resistance | | More than 100MΩ at 25°C and 70%RH Output - FG : 500VDC | | | | | | |
| Standards | Safety | | Approved by UL60950-1, CSA60950-1, EN60950-1 Designed to meet Den-an Appendix 8 at 100VAC only. | | | | | | |
| | PFHC | | Designed to meet IEC61000-3-2 | | | | | | |
| | Conducted Emission, Radiated Emission | (*12) | Designed to meet EN55011/EN55022-B, FCC-B, VCCI-B | | | | | | |
| | Immunity | (*12) | Designed to meet IEC61000-6-2 IEC61000-4-2, -3, -4, -5, -6, -8, -11 | | | | | | |
| Mechanical | Weight (typ) | g | 470 | | | | | | |
| | Size (W x H x D) | mm | 37 x 82 x 160 (Refer to Outline Drawing) | | | | | | |

(*1) At 100VAC/200VAC, Ta=25°C, nominal output voltage and maximum output power.

(*2) For cases where conformance to various safety specs (UL, CSA, EN) are required, to be described as 100 - 240VAC(50 - 60Hz).

(*3) Not applicable for the inrush current to Noise Filter for less than 0.2ms.

(*4) Measure with JEITA RC-9131B probe, Bandwidth of scope :100MHz.

(*5) 85 - 265VAC, constant load.

(*6) No load-Full load, constant input voltage.

(*7) Constant current limit and hiccup with automatic recovery.
Avoid to operate at over load or short circuit condition.

(*8) OVP circuit will shut down output, manual reset (Re power on).

(*9) Measured by the each measuring method of UL, CSA, EN and Den-an (at 60Hz), Ta=25°C.

(*10) Output Derating

- Refer to Output Derating Curve.

- Load (%) is percent of maximum output power or maximum output current, do not exceed its derating of maximum load.

- For conditions of start up at -40°C to -10°C, refer to Start-up condition at low temperature.

(*11) Category 4 exposure levels : Track transportation over U.S. highways, Composite two-wheeled trailer.

(*12) The power supply is considered a component which will be installed into a final equipment.

The final equipment should be re-evaluated that it meets EMC directives.

Recommended EMC Filter

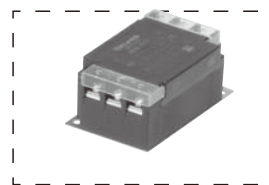

RSEN-2003D or RSEN-2003

Please refer to "TDK-Lambda
EMC Filters" catalog.

Outline Drawing

UNIT - PC Board

[HWS150A/HD]

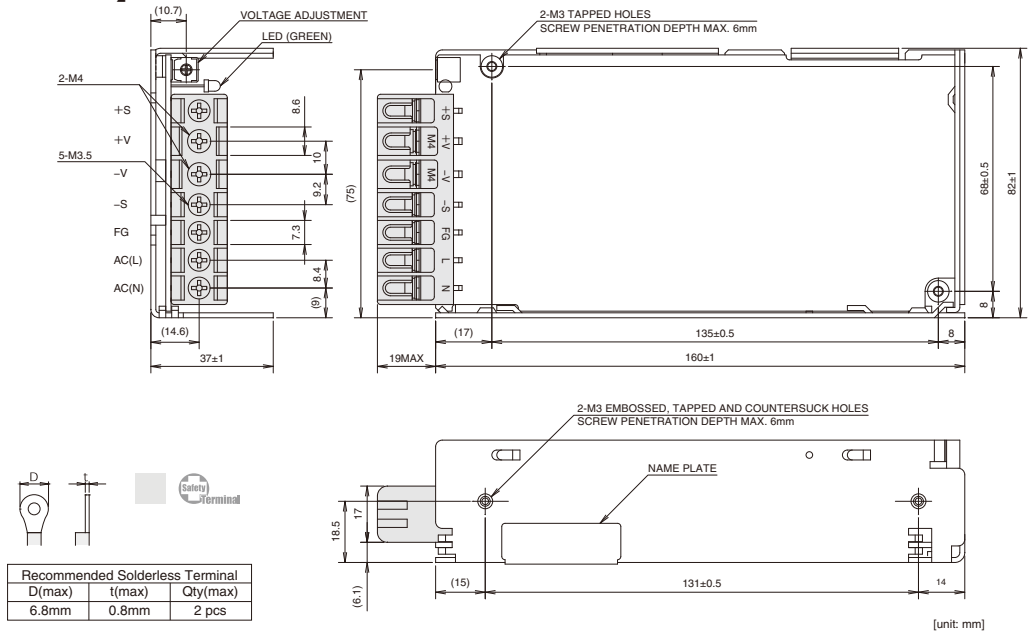

HWS-A/HD

Output Derating

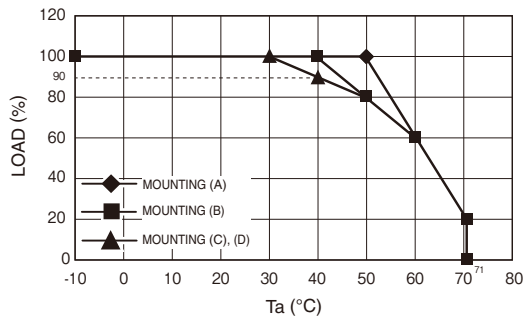

| Ta (°C) | LOAD (%) | | |
|------------|--------------|--------------|------------------|
| | MOUNTING (A) | MOUNTING (B) | MOUNTING (C),(D) |
| -10 to +30 | 100 | 100 | 100 |
| 40 | 100 | 100 | 90 |
| 50 | 100 | 80 | 80 |
| 60 | 60 | 60 | 60 |
| 71 | 20 | 20 | 20 |

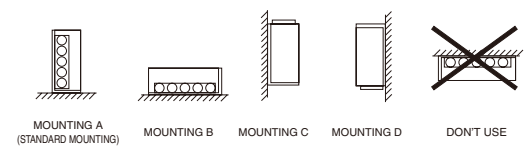

Start-up condition at low temperature

● DERATING TO START UP AT Ta : -40 to -10°C

| Input Voltage (VAC) | LOAD(%) | |
|---------------------|------------------|---|
| | Normal start up. | Stable output after 1 min from start up |
| 85 ≤ Vin < 100 | 80 | 100 |
| 100 ≤ Vin ≤ 265 | 100 | 100 |

=NOTES=

- * At Ta : -40 to -10° C.
- * Input voltage : Not gradual start up.
- * Do not use the load that is constant current mode.
- * Avoid forced air cooling. It is assumed that inside of power supply is heated by self-heating within 1 minutes.
- * No condensing.
- * Pay attention to above items before using the unit. Incorrect usage could lead to unstable output voltage.

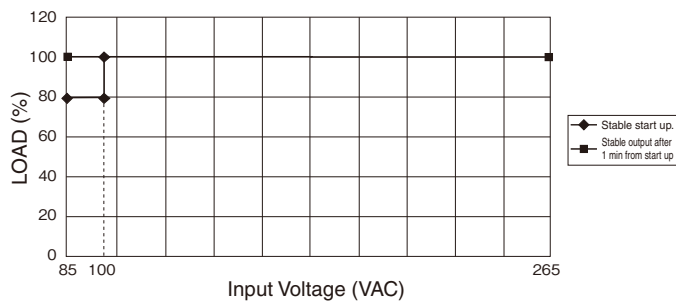

TDK·Lambda

HWS-A/ME

Single Output 30W ~ 150W

UNIT - PC Board



Features

- AC-DC switching power supply for medical equipment.
 - Approval ES60601-1 (*1)
 - Approval EN60601-1 (*1)
 - Approval CSA-C22.2 No.60601-1 (*1)
- Environmentally-friendly
 - Contributing to energy conservation of the customer's equipment in a further high efficiency
- Easy to use
 - All models in the same height of 82mm. Mountable in 2U-height racks without dead space.
- Safety and security
 - Reduce the maintenance frequency of your device by a long life
 - Double-sided board adopted inherited the conventional model
 - "Safety terminal" covering current flowing part secures safety for users. "No screw-dropping" design prevents from losing screws during maintenance operation.

Applications



Model naming method

[HWS30A-150A]
HWS 50A - 5 / ME

Series name Output power

ME : Without cover, approved by safety standards for medical equipment
 MEA : With cover, approved by safety standards for medical equipment

Nominal Output Voltage
 ex. 5 : 5V, 48 : 48V

Conformity to RoHS Directive

This means that, in conformity with EU Directive 2011/65/EU, lead, cadmium, mercury, hexavalent chromium, and specific bromine-based flame retardants, PBB and PBDE, have not been used, except for exempted applications.

HWS-A/ME

Product Line up

| Output Voltage | 30W | | 50W | | 100W | | 150W | |
|----------------|----------------|--------------|----------------|--------------|----------------|---------------|----------------|---------------|
| | Output Current | MODEL | Output Current | MODEL | Output Current | MODEL | Output Current | MODEL |
| 5V | 6A | HWS30A-5/ME | 10A | HWS50A-5/ME | 20A | HWS100A-5/ME | 30A | HWS150A-5/ME |
| 12V | 2.5A | HWS30A-12/ME | 4.3A | HWS50A-12/ME | 8.5A | HWS100A-12/ME | 13A | HWS150A-12/ME |
| 15V | 2A | HWS30A-15/ME | 3.5A | HWS50A-15/ME | 7A | HWS100A-15/ME | 10A | HWS150A-15/ME |
| 24V | 1.3A | HWS30A-24/ME | 2.2A | HWS50A-24/ME | 4.5A | HWS100A-24/ME | 6.5A | HWS150A-24/ME |
| 48V | 0.65A | HWS30A-48/ME | 1.1A | HWS50A-48/ME | 2.1A | HWS100A-48/ME | 3.3A | HWS150A-48/ME |

(*1) The following conditions are required.

- Please use the insulating material for the equipment chassis when the power supply is used in the equipment near patients.
- Approved with the basic insulation, an additional insulation circuit is required outside of the power supply.

• All specifications are subject to change without notice.

HWS30A/ME SPECIFICATIONS (Read instruction manual carefully, before using the power supply unit.)

UNIT
PC Board

| ITEMS/UNITS | | MODEL | HWS30A -5/ME | HWS30A -12/ME | HWS30A -15/ME | HWS30A -24/ME | HWS30A -48/ME |
|-------------|--|----------|--|------------------|------------------|------------------|------------------|
| Input | Input Voltage Range | (*2) V | AC85 - 265 (47 - 63Hz) or DC120 - 370 | | | | |
| | Efficiency(100VAC) (typ) | (*1) % | 80 | 84 | 85 | 86 | 86 |
| | Efficiency(200VAC) (typ) | (*1) % | 82 | 86 | 87 | 88 | 87 |
| | Input Current (100/200VAC) (typ) | (*1) A | 0.65/0.4 | | | | |
| | Inrush Current (100/200VAC) (typ) (*1)(*3) | A | 14/28 (Ta = 25°C, Cold Start) | | | | |
| | Leakage Current | (*9) mA | Less than 0.5 (0.2 (typ) at 100VAC / 0.4 (typ) at 230VAC) | | | | |
| Output | Nominal Output Voltage | VDC | 5 | 12 | 15 | 24 | 48 |
| | Maximum Output Current | A | 6 | 2.5 | 2 | 1.3 | 0.65 |
| | Maximum Output Power | W | 30.0 | 30.0 | 30.0 | 31.2 | 31.2 |
| | Maximum Line Regulation | (*5) mV | 20 | 48 | 60 | 96 | 192 |
| | Maximum Load Regulation | (*6) mV | 40 | 96 | 120 | 150 | 240 |
| | Temperature Coefficient | | Less than 0.02% /°C | | | | |
| | Maximum Ripple & Noise(0≤Ta≤70°C) (*4) | mV | 120 | 150 | 150 | 150 | 200 |
| | Maximum Ripple & Noise(-10≤Ta<0°C) (*4) | mV | 160 | 180 | 180 | 180 | 240 |
| | Hold-up Time (typ) | (*1) ms | 20 | | | | |
| | Output Voltage Range | VDC | 4.0 - 6.0 | 9.6 - 14.4 | 12.0 - 18.0 | 19.2 - 28.8 | 38.4 - 52.8 |
| Function | Over Current Protection | (*7) A | 6.3 — | 2.62 — | 2.1 — | 1.36 — | 0.68 — |
| | Over Voltage Protection | (*8) VDC | 6.25 - 7.25 | 15.0 - 17.4 | 18.8 - 21.8 | 30.0 - 34.8 | 55.2 - 64.8 |
| | Remote Sensing | | - | | | | |
| | Parallel Operation | | - | | | | |
| | Series Operation | | Possible | | | | |
| Environment | Line DIP | | Designed to meet SEMI-F47 (200VAC Line only) | | | | |
| | Operating Temperature | (*10) °C | -10 to +70 (-10 to +50°C :100%, +60°C :60%, +70°C :40%) | | | | |
| | Storage Temperature | °C | -30 to +85 | | | | |
| | Operating Humidity | % RH | 30 - 90 (No Condensing) | | | | |
| | Storage Humidity | % RH | 10 - 95 (No Condensing) | | | | |
| | Vibration | | At no operating, 10-55Hz (Sweep for 1min) 19.6m/s ² Constant, X,Y,Z 1hour each. | | | | |
| | Shock | | Less than 196.1m/s ² | | | | |
| Isolation | Cooling | | Convection Cooling | | | | |
| | Withstand Voltage | | Input - FG : 2kVAC (20mA), Input - Output : 3kVAC (20mA) Output - FG : 500VAC (20mA) for 1min | | | | |
| | Isolation Resistance | | More than 100MΩ at 25°C and 70%RH Output - FG : 500VDC | | | | |
| Standards | Safety | (*11) | Approved by ES60601-1, EN60601-1, CSA-C22.2 No.60601-1 | | | | |
| | PFHC | | Designed to meet IEC61000-3-2 | | | | |
| | Voltage Fluctuations / Flicker Emissions | | Designed to meet IEC61000-3-3 | | | | |
| | Conducted Emission, Radiated Emission | (*12) | Designed to meet EN55011/EN55022-B, FCC-B, VCCI-B | | | | |
| Mechanical | Immunity | (*12) | Designed to meet IEC61000-6-2 IEC61000-4-2, -3, -4, -5, -6, -8, -11 | | | | |
| | Weight (typ) | g | 200 | | | | |
| | Size (W x H x D) | mm | 26.5 x 82 x 95 (Refer to Outline Drawing) | | | | |

(*1) At 100VAC/200VAC, Ta=25° C, nominal output voltage and maximum output power.

(*2) For cases where conformance to various safety specs (UL, CSA, EN) are required, to be described as 100 - 240VAC(50 - 60Hz).

(*3) Not applicable for the inrush current to Noise Filter for less than 0.2ms.

(*4) Measure with JEITA RC-9131B probe, Bandwidth of scope :100MHZ.
For start up at low ambient temperature and low input voltage, output ripple noise might not meet specification.
However, specification can be met after one second.

(*5) 85 - 265VAC, constant load.

(*6) No load-Full load, constant input voltage.

(*7) Hiccup with automatic recovery. Avoid to operate at over load or short circuit condition.

(*8) OVP circuit will shut down output, manual reset (Re power on).

(*9) Measured by the each measuring method of UL, EN, and CSA (at 60Hz), Ta = 25°C

(*10) Output Derating

- Refer to Output Derating Curve.

- Load (%) is percent of maximum output power or maximum output current, do not exceed its derating of maximum load.

(*11) It is the third edition, authorization in MOOP of ES60601-1, EN60601-1, CSA-C22.2 No. 60,601-1.

(*12) The power supply is considered a component which will be installed into a final equipment.

The final equipment should be re-evaluated that it meets EMC directives.

Recommended EMC Filter



RSEN-2003D or RSEN-2003

Please refer to "TDK-Lambda
EMC Filters" catalog.

Outline Drawing

UNIT -
PC Board

[HWS30A/ME]

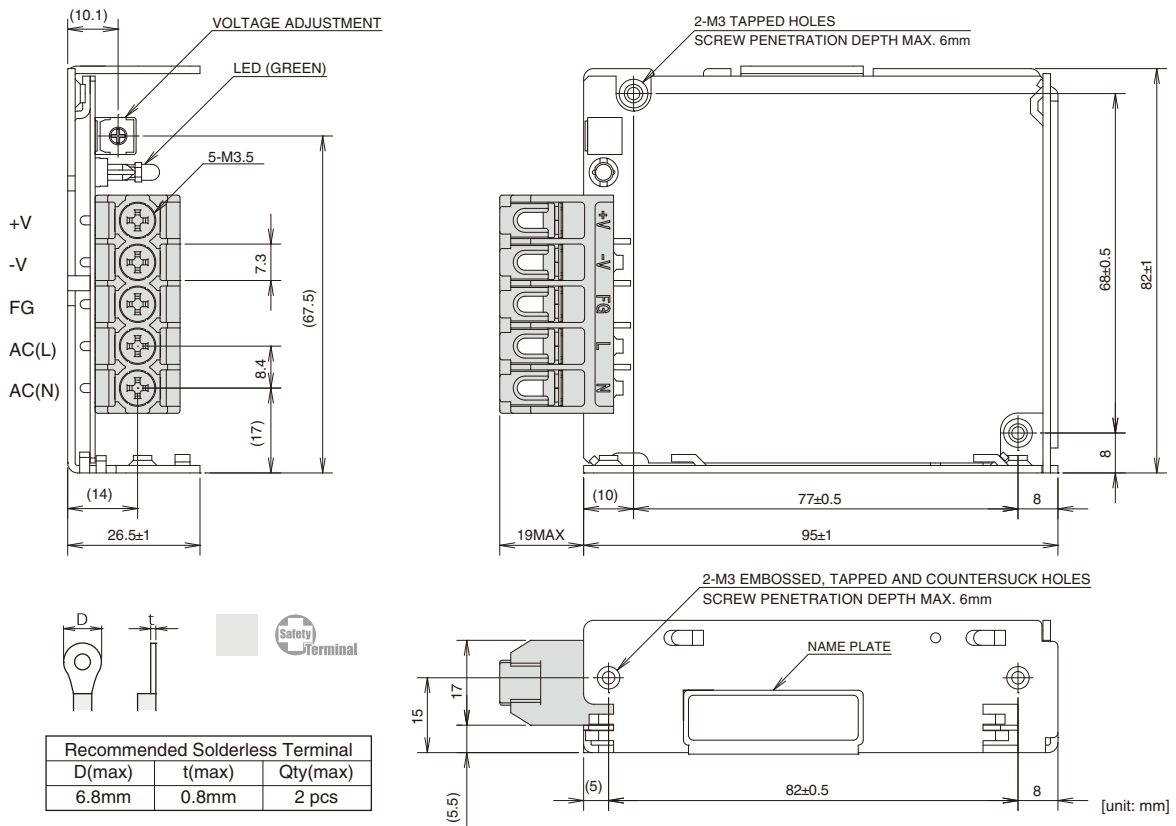

HWS-A/ME

Output Derating

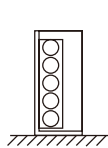
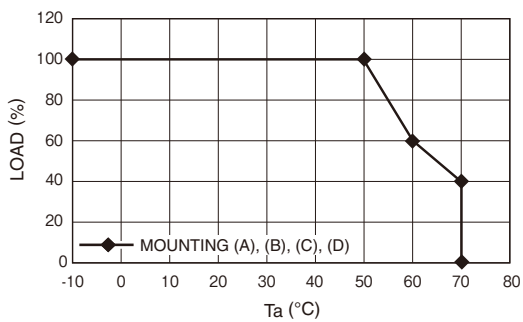

MOUNTING A
(STANDARD MOUNTING)

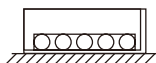

MOUNTING B

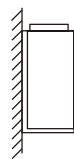

MOUNTING C



MOUNTING D

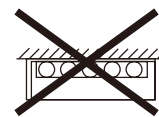

DON'T USE

HWS50A/ME SPECIFICATIONS (Read instruction manual carefully, before using the power supply unit.)

UNIT
PC Board

| ITEMS/UNITS | | MODEL | HWS50A -5/ME | HWS50A -12/ME | HWS50A -15/ME | HWS50A -24/ME | HWS50A -48/ME |
|-----------------|--|---|--|------------------|------------------|------------------|------------------|
| Input | Input Voltage Range | (*2) V | AC85 - 265 (47 - 63Hz) or DC120 - 370 | | | | |
| | Power Factor(100/200VAC) (typ) | (*1) | 0.97/0.91 | | | | |
| | Efficiency(100VAC) (typ) | (*1) % | 82 | 83 | 83 | 84 | 84 |
| | Efficiency(200VAC) (typ) | (*1) % | 84 | 85 | 86 | 87 | 86 |
| | Input Current (100/200VAC) (typ) | (*1) A | 0.65/0.35 | | | | |
| | Inrush Current (100/200VAC) (typ) (*1)(*3) | A | 14/28 (Ta = 25°C, Cold Start) | | | | |
| Leakage Current | (*9) mA | Less than 0.5 (0.2 (typ) at 100VAC / 0.4 (typ) at 230VAC) | | | | | |
| Output | Nominal Output Voltage | VDC | 5 | 12 | 15 | 24 | 48 |
| | Maximum Output Current | A | 10 | 4.3 | 3.5 | 2.2 | 1.1 |
| | Maximum Output Power | W | 50.0 | 51.6 | 52.5 | 52.8 | 52.8 |
| | Maximum Line Regulation | (*5) mV | 20 | 48 | 60 | 96 | 192 |
| | Maximum Load Regulation | (*6) mV | 40 | 96 | 120 | 150 | 240 |
| | Temperature Coefficient | | Less than 0.02% /°C | | | | |
| | Maximum Ripple & Noise(0≤Ta≤70°C) (*4) | mV | 120 | 150 | 150 | 150 | 200 |
| | Maximum Ripple & Noise(-10≤Ta<0°C) (*4) | mV | 160 | 180 | 180 | 180 | 240 |
| | Hold-up Time (typ) | (*1) ms | 20 | | | | |
| | Output Voltage Range | VDC | 4.0 - 6.0 | 9.6 - 14.4 | 12.0 - 18.0 | 19.2 - 28.8 | 38.4 - 52.8 |
| Function | Over Current Protection | (*7) A | 10.5 - | 4.51 - | 3.67 - | 2.31 - | 1.15 - |
| | Over Voltage Protection | (*8) VDC | 6.25 - 7.25 | 15.0 - 17.4 | 18.8 - 21.8 | 30.0 - 34.8 | 55.2 - 64.8 |
| | Remote Sensing | | - | | | | |
| | Parallel Operation | | - | | | | |
| | Series Operation | | Possible | | | | |
| Line DIP | | Designed to meet SEMI-F47 (200VAC Line only) | | | | | |
| Environment | Operating Temperature | (*10) °C | -10 to +70 (-10 to +50°C :100%, +60°C :70%, +70°C :40%) | | | | |
| | Storage Temperature | °C | -30 to +85 | | | | |
| | Operating Humidity | % RH | 30 - 90 (No Condensing) | | | | |
| | Storage Humidity | % RH | 10 - 95 (No Condensing) | | | | |
| | Vibration | | At no operating, 10-55Hz (Sweep for 1min) 19.6m/s ² Constant, X,Y,Z 1hour each. | | | | |
| | Shock | | Less than 196.1m/s ² | | | | |
| | Cooling | | Convection Cooling | | | | |
| Isolation | Withstand Voltage | | Input - FG : 2kVAC (20mA), Input - Output : 3kVAC (20mA) Output - FG : 500VAC (20mA) for 1min | | | | |
| | Isolation Resistance | | More than 100MΩ at 25°C and 70%RH Output - FG : 500VDC | | | | |
| Standards | Safety | (*11) | Approved by ES60601-1, EN60601-1, CSA-C22.2 No.60601-1 | | | | |
| | PFHC | | Designed to meet IEC61000-3-2 | | | | |
| | Voltage Fluctuations / Flicker Emissions | | Designed to meet IEC61000-3-3 | | | | |
| | Conducted Emission, Radiated Emission | (*12) | Designed to meet EN55011/EN55022-B, FCC-B, VCCI-B | | | | |
| | Immunity | (*12) | Designed to meet IEC61000-6-2 IEC61000-4-2, -3, -4, -5, -6, -8, -11 | | | | |
| Mechanical | Weight (typ) | g | 260 | | | | |
| | Size (W x H x D) | mm | 26.5 x 82 x 120 (Refer to Outline Drawing) | | | | |

(*1) At 100VAC/200VAC, Ta=25° C, nominal output voltage and maximum output power.

(*2) For cases where conformance to various safety specs (UL, CSA, EN) are required, to be described as 100 - 240VAC(50 - 60Hz).

(*3) Not applicable for the inrush current to Noise Filter for less than 0.2ms.

(*4) Measure with JEITA RC-9131B probe, Bandwidth of scope :100MHz.

(*5) 85 - 265VAC, constant load.

(*6) No load-Full load, constant input voltage.

(*7) Hiccup with automatic recovery. Avoid to operate at over load or short circuit condition.

(*8) OVP circuit will shut down output, manual reset (Re power on).

(*9) Measured by the each measuring method of UL, EN, and CSA (at 60Hz), Ta = 25°C

(*10) Output Derating

- Refer to Output Derating Curve.

- Load (%) is percent of maximum output power or maximum output current, do not exceed its derating of maximum load.

(*11) It is the third edition, authorization in MOOP of ES60601-1, EN60601-1, CSA-C22.2 No. 60,601-1.

(*12) The power supply is considered a component which will be installed into a final equipment.

The final equipment should be re-evaluated that it meets EMC directives.

Recommended EMC Filter

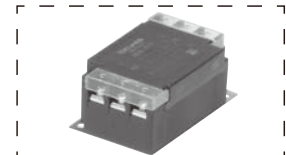

RSEN-2003D or RSEN-2003
Please refer to "TDK-Lambda
EMC Filters" catalog.

Outline Drawing

UNIT - PC Board

[HWS50A/ME]

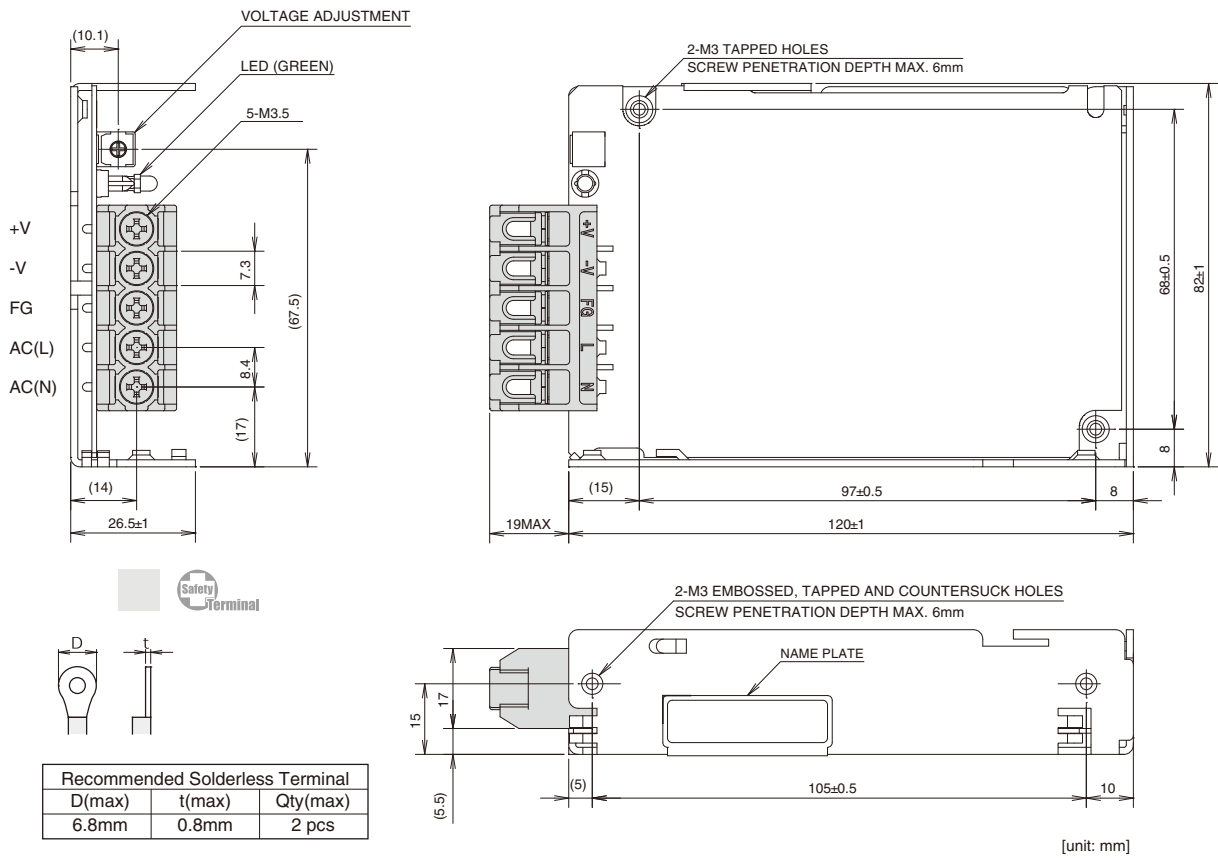

HWS-A/ME

Output Derating

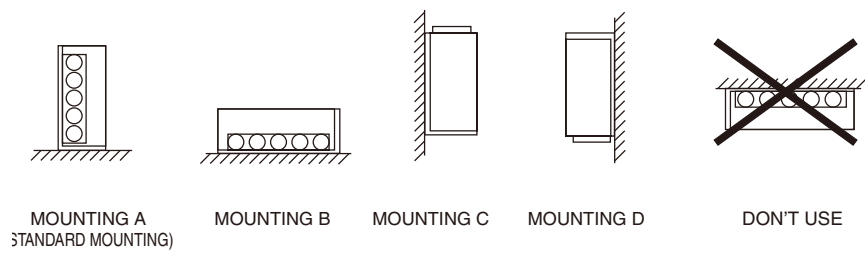
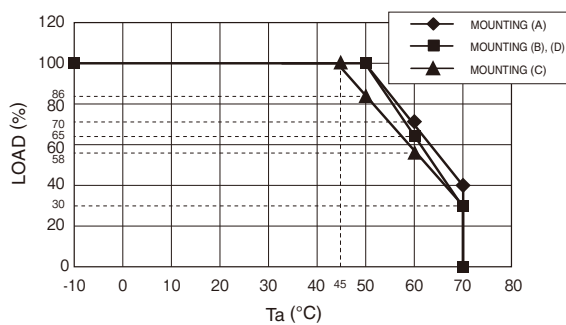

• All specifications are subject to change without notice.

HWS100A/ME SPECIFICATIONS (Read instruction manual carefully, before using the power supply unit.)

| ITEMS/UNITS | | MODEL | HWS100A -5/ME | HWS100A -12/ME | HWS100A -15/ME | HWS100A -24/ME | HWS100A -48/ME |
|-------------|--|----------|--|-------------------|-------------------|-------------------|-------------------|
| Input | Input Voltage Range | (*2) V | AC85 - 265 (47 - 63Hz) or DC120 - 370 | | | | |
| | Power Factor(100/200VAC) (typ) | (*1) | 0.98/0.93 | | | | |
| | Efficiency(100VAC) (typ) | (*1) % | 84 | 86 | 86 | 87 | 88 |
| | Efficiency(200VAC) (typ) | (*1) % | 86 | 88 | 88 | 89 | 90 |
| | Input Current (100/200VAC) (typ) | (*1) A | 1.3/0.65 | | | | |
| | Inrush Current (100/200VAC) (typ) (*1)(*3) | A | 14/28 (Ta = 25°C Cold Start) | | | | |
| | Leakage Current | (*9) mA | Less than 0.5 (0.2 (typ) at 100VAC / 0.4 (typ) at 230VAC) | | | | |
| Output | Nominal Output Voltage | VDC | 5 | 12 | 15 | 24 | 48 |
| | Maximum Output Current | A | 20 | 8.5 | 7 | 4.5 | 2.1 |
| | Maximum Output Power | W | 100.0 | 102.0 | 105.0 | 108.0 | 100.8 |
| | Maximum Line Regulation | (*5) mV | 20 | 48 | 60 | 96 | 192 |
| | Maximum Load Regulation | (*6) mV | 40 | 96 | 120 | 150 | 240 |
| | Temperature Coefficient | | Less than 0.02% /°C | | | | |
| | Maximum Ripple & Noise(0≤Ta≤70°C) (*4) | mV | 120 | 150 | 150 | 150 | 200 |
| | Maximum Ripple & Noise(-10≤Ta<0°C) (*4) | mV | 160 | 180 | 180 | 180 | 240 |
| | Hold-up Time (typ) | (*1) ms | 20 | | | | |
| | Output Voltage Range | VDC | 4.0 - 6.0 | 9.6 - 14.4 | 12.0 - 18.0 | 19.2 - 28.8 | 38.4 - 52.8 |
| Function | Over Current Protection | (*7) A | 21.0 — | 8.92 — | 7.35 — | 4.72 — | 2.20 — |
| | Over Voltage Protection | (*8) VDC | 6.25 - 7.25 | 15.0 - 17.4 | 18.8 - 21.8 | 30.0 - 34.8 | 55.2 - 64.8 |
| | Remote Sensing | | Possible | | | | |
| | Parallel Operation | | - | | | | |
| | Series Operation | | Possible | | | | |
| | Line DIP | | Designed to meet SEMI-F47 (200VAC Line only) | | | | |
| Environment | Operating Temperature | (*10) °C | -10 to +70 (-10 to +50°C :100%, +60°C :65%, +70°C :30%) | | | | |
| | Storage Temperature | °C | -30 to +85 | | | | |
| | Operating Humidity | % RH | 30 - 90 (No Condensing) | | | | |
| | Storage Humidity | % RH | 10 - 95 (No Condensing) | | | | |
| | Vibration | | At no operating, 10-55Hz (Sweep for 1min) 19.6m/s ² Constant, X,Y,Z 1hour each. | | | | |
| | Shock | | Less than 196.1m/s ² | | | | |
| | Cooling | | Convection Cooling | | | | |
| Isolation | Withstand Voltage | | Input - FG : 2kVAC (20mA), Input - Output : 3kVAC (20mA) Output - FG : 500VAC (20mA) for 1min | | | | |
| | Isolation Resistance | | More than 100MΩ at 25°C and 70%RH Output - FG : 500VDC | | | | |
| Standards | Safety | (*11) | Approved by ES60601-1, EN60601-1, CSA-C22.2 No.60601-1 | | | | |
| | PFHC | | Designed to meet IEC61000-3-2 | | | | |
| | Voltage Fluctuations / Flicker Emissions | | Designed to meet IEC61000-3-3 | | | | |
| | Conducted Emission, Radiated Emission | (*12) | Designed to meet EN55011/EN55022-B, FCC-B, VCCI-B | | | | |
| Mechanical | Immunity | (*12) | Designed to meet IEC61000-6-2 IEC61000-4-2, -3, -4, -5, -6, -8, -11 | | | | |
| | Weight (typ) | g | 420 | | | | |
| | Size (W x H x D) | mm | 28 x 82 x 160 (Refer to Outline Drawing) | | | | |

(*1) At 100VAC/200VAC, Ta=25° C, nominal output voltage and maximum output power.

(*2) For cases where conformance to various safety specs (UL, CSA, EN) are required, to be described as 100 - 240VAC(50 - 60Hz).

(*3) Not applicable for the inrush current to Noise Filter for less than 0.2ms.

(*4) Measure with JEITA RC-9131B probe, Bandwidth of scope :100MHz.

(*5) 85 - 265VAC, constant load.

(*6) No load-Full load, constant input voltage.

(*7) Constant current limit and hiccup with automatic recovery.

Avoid to operate at over load or short circuit condition.

(*8) OVP circuit will shut down output, manual reset (Re power on).

(*9) Measured by the each measuring method of UL, EN, and CSA (at 60Hz), Ta = 25°C

(*10) Output Derating

- Refer to Output Derating Curve.

- Load (%) is percent of maximum output power or maximum output current, do not exceed its derating of maximum load.

(*11) It is the third edition, authorization in MOOP of ES60601-1, EN60601-1, CSA-C22.2 No. 60,601-1.

(*12) The power supply is considered a component which will be installed into a final equipment.

The final equipment should be re-evaluated that it meets EMC directives.

Recommended EMC Filter

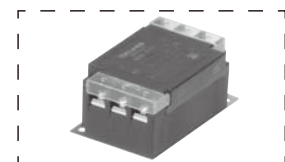

RSEN-2003D or RSEN-2003

Please refer to "TDK-Lambda

EMC Filters" catalog.

Outline Drawing

UNIT - PC Board

[HWS100A/ME]

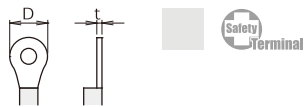
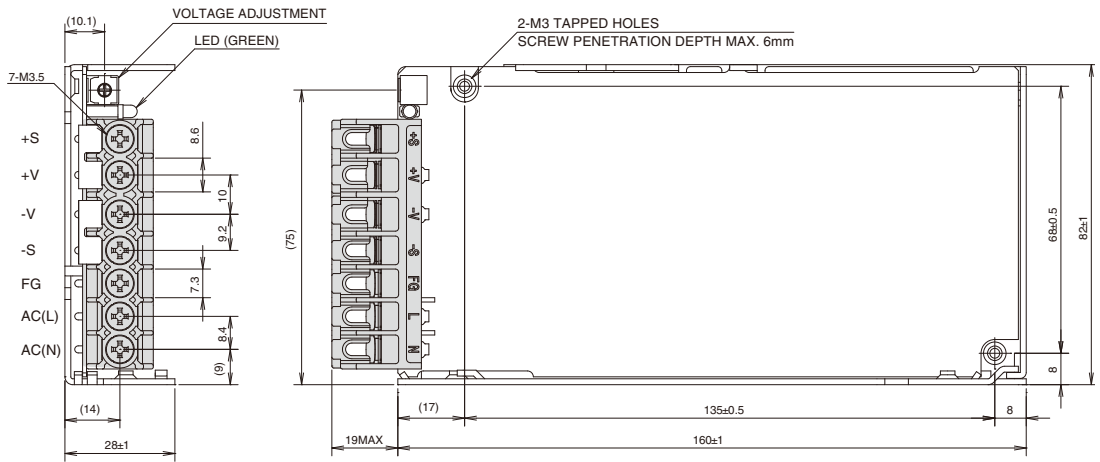

| Terminal | Recommended Solderless Terminal | | |
|----------|---------------------------------|--------|----------|
| | D(max) | t(max) | Qty(max) |
| +V / -V | 8.1mm | 0.8mm | 2 pcs |
| | | 1.0mm | 1 pcs |
| Others | 6.8mm | 0.8mm | 2 pcs |

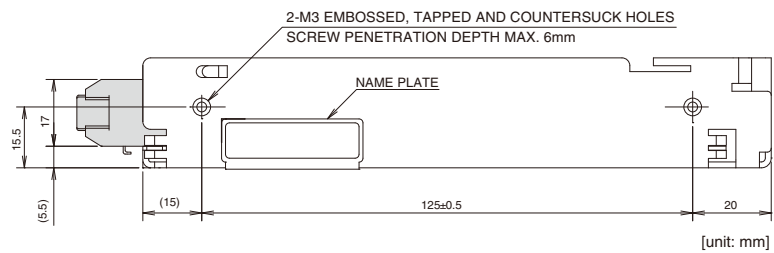

HWS-A/ME

Output Derating

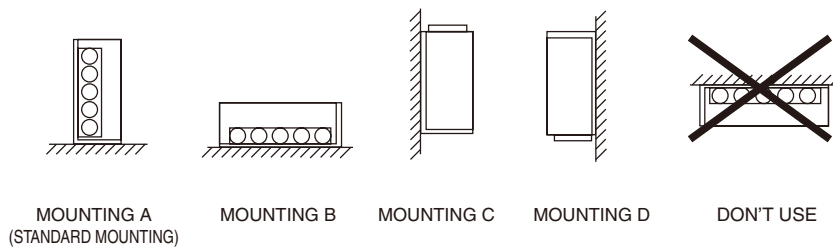
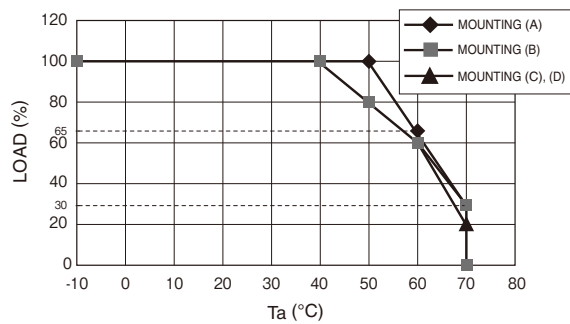

• All specifications are subject to change without notice.

HWS150A/ME SPECIFICATIONS (Read instruction manual carefully, before using the power supply unit.)

UNIT
PC Board

| ITEMS/UNITS | | MODEL | HWS150A -5/ME | HWS150A -12/ME | HWS150A -15/ME | HWS150A -24/ME | HWS150A -48/ME |
|-----------------|--|---|--|-------------------|-------------------|-------------------|-------------------|
| Input | Input Voltage Range | (*2) V | AC85 - 265 (47 - 63Hz) or DC120 - 370 | | | | |
| | Power Factor(100/200VAC) (typ) | (*1) | 0.98/0.93 | | | | |
| | Efficiency(100VAC) (typ) | (*1) % | 85 | 85 | 86 | 88 | 89 |
| | Efficiency(200VAC) (typ) | (*1) % | 87 | 88 | 89 | 90 | 91 |
| | Input Current (100/200VAC) (typ) | (*1) A | 1.9/0.95 | | | | |
| | Inrush Current (100/200VAC) (typ) | (*1)(*3) A | 14/28 (Ta = 25°C, Cold Start) | | | | |
| Leakage Current | (*9) mA | Less than 0.5 (0.2 (typ) at 100VAC / 0.4 (typ) at 230VAC) | | | | | |
| Output | Nominal Output Voltage | VDC | 5 | 12 | 15 | 24 | 48 |
| | Maximum Output Current | A | 30 | 13 | 10 | 6.5 | 3.3 |
| | Maximum Output Power | W | 150.0 | 156.0 | 150.0 | 156.0 | 158.4 |
| | Maximum Line Regulation | (*5) mV | 20 | 48 | 60 | 96 | 192 |
| | Maximum Load Regulation | (*6) mV | 40 | 96 | 120 | 150 | 240 |
| | Temperature Coefficient | | Less than 0.02% /°C | | | | |
| | Maximum Ripple & Noise(0≤Ta≤70°C) (*4) | mV | 120 | 150 | 150 | 150 | 200 |
| | Maximum Ripple & Noise(-10≤Ta<0°C) (*4) | mV | 160 | 180 | 180 | 180 | 240 |
| | Hold-up Time (typ) | (*1) ms | 20 | | | | |
| | Output Voltage Range | VDC | 4.0 - 6.0 | 9.6 - 14.4 | 12.0 - 18.0 | 19.2 - 28.8 | 38.4 - 52.8 |
| Function | Over Current Protection | (*7) A | 31.5 — | 13.6 — | 10.5 — | 6.82 — | 3.46 — |
| | Over Voltage Protection | (*8) VDC | 6.25 - 7.25 | 15.0 - 17.4 | 18.8 - 21.8 | 30.0 - 34.8 | 55.2 - 64.8 |
| | Remote Sensing | | Possible | | | | |
| | Parallel Operation | | - | | | | |
| | Series Operation | | Possible | | | | |
| | Line DIP | | Designed to meet SEMI-F47 (200VAC Line only) | | | | |
| Environment | Operating Temperature | (*10) °C | -10 to +70 (-10 to +50°C :100%, +60°C :60%, +70°C :20%) | | | | |
| | Storage Temperature | °C | -30 to +85 | | | | |
| | Operating Humidity | % RH | 30 - 90 (No Condensing) | | | | |
| | Storage Humidity | % RH | 10 - 95 (No Condensing) | | | | |
| | Vibration | | At no operating, 10-55Hz (Sweep for 1min) 19.6m/s ² Constant, X,Y,Z 1hour each. | | | | |
| | Shock | | Less than 196.1m/s ² | | | | |
| | Cooling | | Convection Cooling | | | | |
| Isolation | Withstand Voltage | | Input - FG : 2kVAC (20mA), Input - Output : 3kVAC (20mA) Output - FG : 500VAC (20mA) for 1min | | | | |
| | Isolation Resistance | | More than 100MΩ at 25°C and 70%RH Output - FG : 500VDC | | | | |
| Standards | Safety | (*11) | Approved by ES60601-1, EN60601-1, CSA-C22.2 No.60601-1 | | | | |
| | PFHC | | Designed to meet IEC61000-3-2 | | | | |
| | Voltage Fluctuations / Flicker Emissions | | Designed to meet IEC61000-3-3 | | | | |
| | Conducted Emission, Radiated Emission | (*12) | Designed to meet EN55011/EN55022-B, FCC-B, VCCI-B | | | | |
| Mechanical | Immunity | (*12) | Designed to meet IEC61000-6-2 IEC61000-4-2, -3, -4, -5, -6, -8, -11 | | | | |
| | Weight (typ) | g | 470 | | | | |
| | Size (W x H x D) | mm | 37 x 82 x 160 (Refer to Outline Drawing) | | | | |

(*1) At 100VAC/200VAC, Ta=25° C, nominal output voltage and maximum output power.

(*2) For cases where conformance to various safety specs (UL, CSA, EN) are required, to be described as 100 - 240VAC(50 - 60Hz).

(*3) Not applicable for the inrush current to Noise Filter for less than 0.2ms.

(*4) Measure with JEITA RC-9131B probe, Bandwidth of scope :100MHz.

(*5) 85 - 265VAC, constant load.

(*6) No load-Full load, constant input voltage.

(*7) Constant current limit and hiccup with automatic recovery.
Avoid to operate at over load or short circuit condition.

(*8) OVP circuit will shut down output, manual reset (Re power on).

(*9) Measured by the each measuring method of UL, EN, and CSA (at 60Hz), Ta = 25°C

(*10) Output Derating

- Refer to Output Derating Curve.

- Load (%) is percent of maximum output power or maximum output current, do not exceed its derating of maximum load.

(*11) It is the third edition, authorization in MOOP of ES60601-1, EN60601-1, CSA-C22.2 No. 60,601-1.

(*12) The power supply is considered a component which will be installed into a final equipment.
The final equipment should be re-evaluated that it meets EMC directives.

Recommended EMC Filter

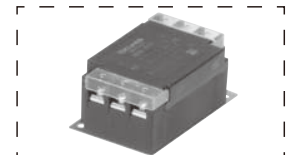

RSEN-2003D or RSEN-2003
Please refer to "TDK-Lambda
EMC Filters" catalog.

Outline Drawing

UNIT - PC Board

[HWS150A/ME]

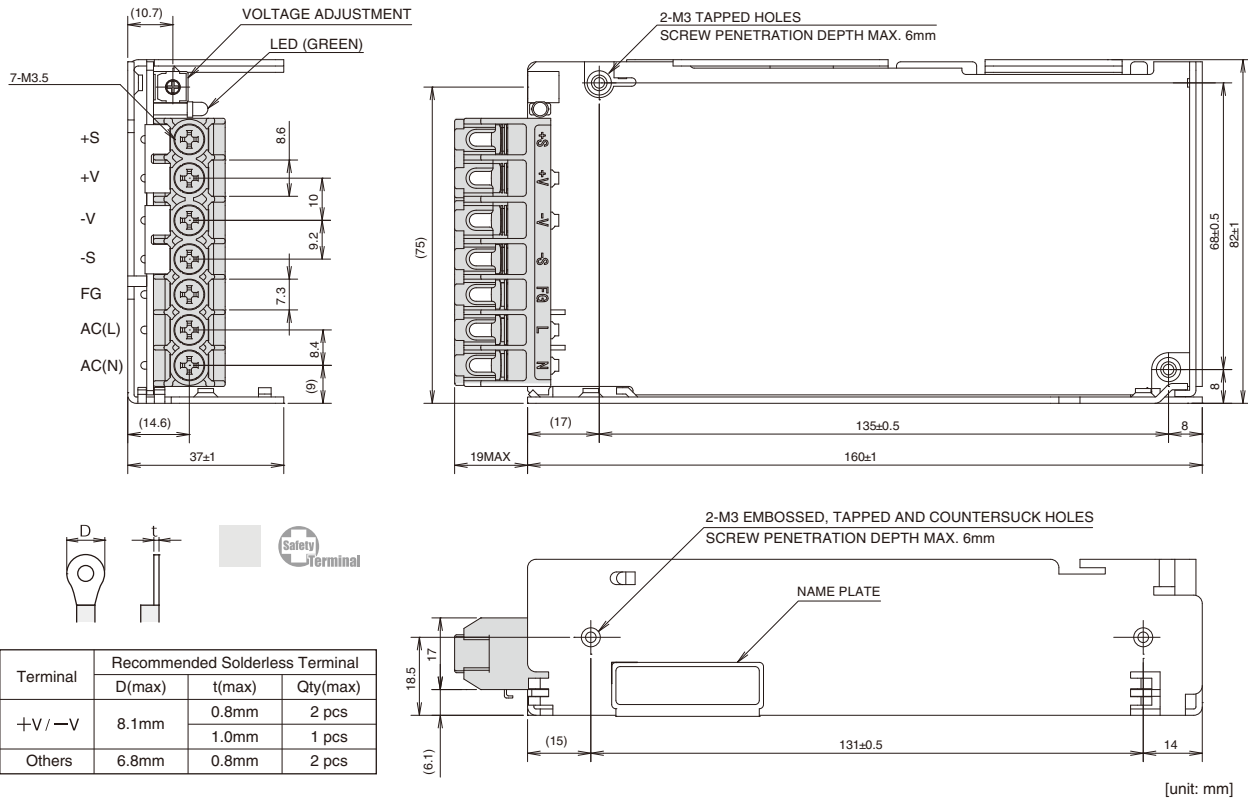

HWS-A/ME

Output Derating

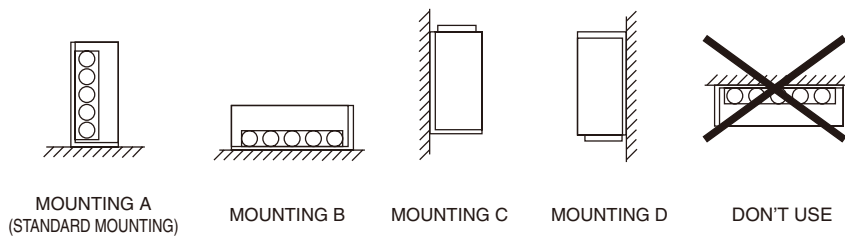
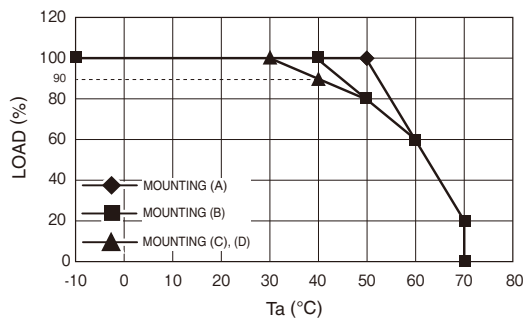

All specifications are subject to change without notice.

TDK·Lambda

Block Diagram

[HWS15A, HWS30A]

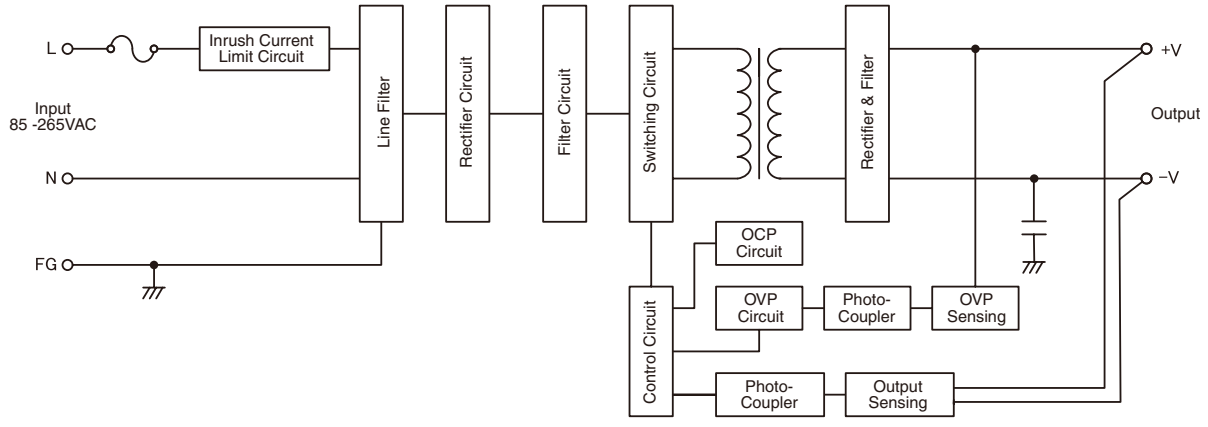

[HWS50A]

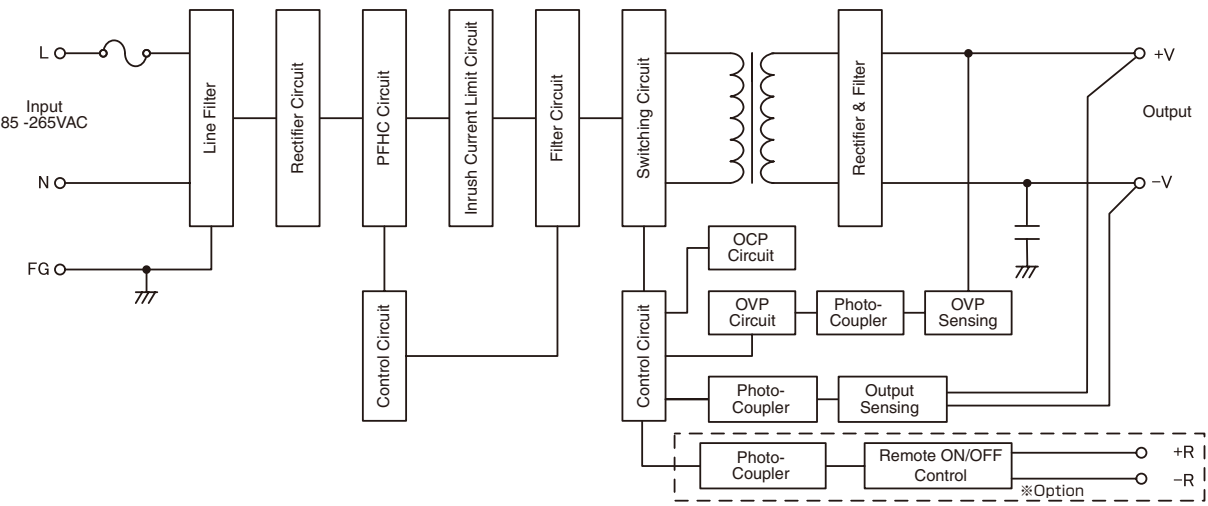

[HWS80A - HWS150A]

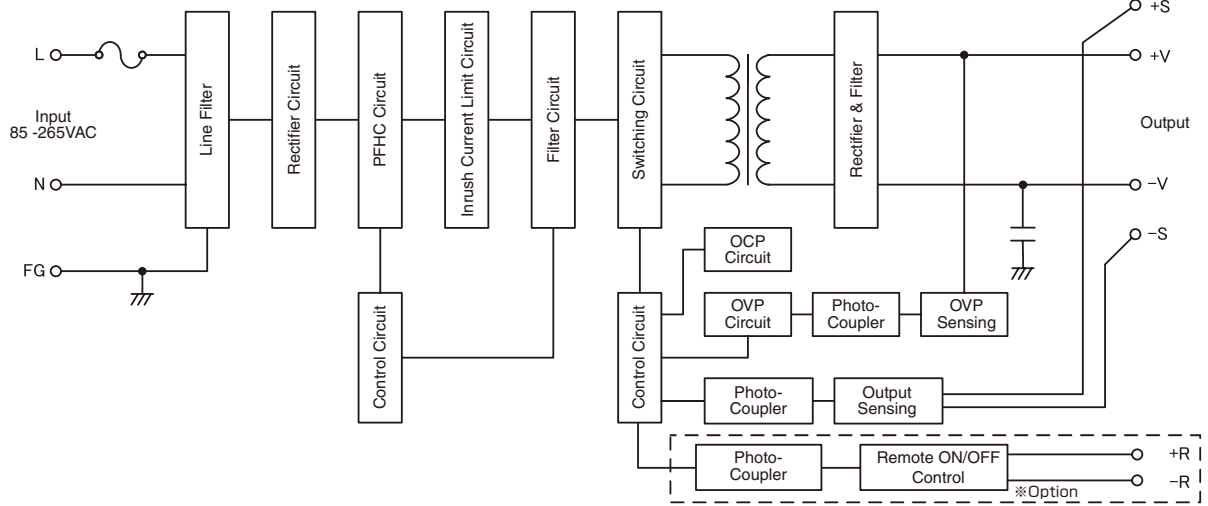

- Fuse rating :
 - HWS15A: 2A
 - HWS30A-100A: 3.15A
 - HWS150A: 5A
- Circuit topology, switching frequency
 - HWS15A-50A: Flyback topology 100kHz (fixed)
 - HWS80A-150A: Cascade forward topology 120kHz (fixed)
 - PFHC circuit : active filter 65kHz (fixed)

• All specifications are subject to change without notice.

Sequence Time Chart

[HWS15A, HWS30A]

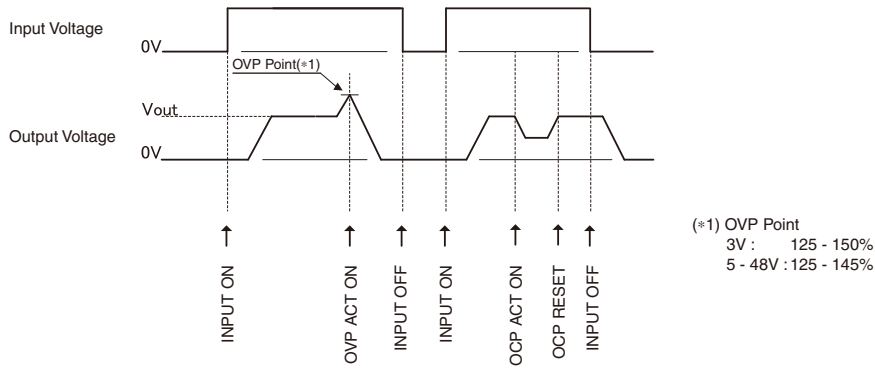

[HWS50A - HWS150A]

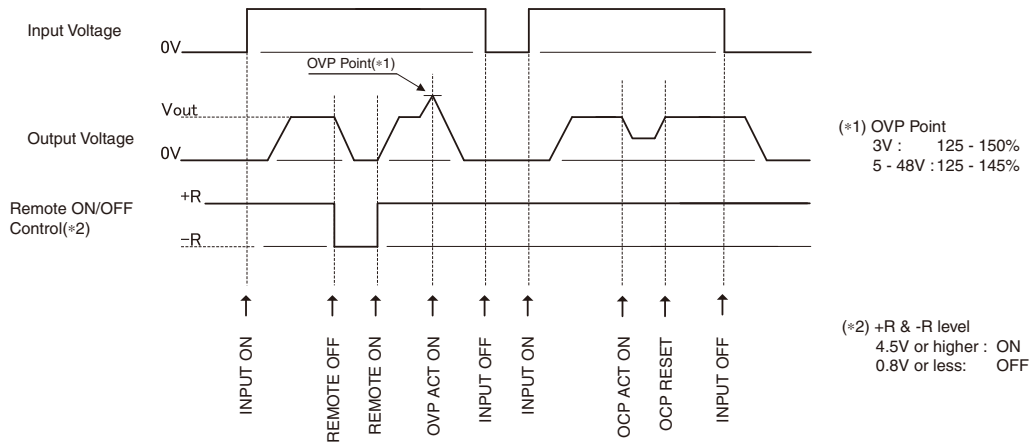

HWS15A, 30A, 50A, 80A, 100A, 150A Instruction Manual

BEFORE USING THE POWER SUPPLY UNIT

Be sure to read this instruction manual thoroughly before using this product. Pay attention to all cautions and warnings before using this product. Incorrect usage could lead to an electrical shock, damage to the unit or a fire hazard.

DANGER

Never use this product in locations where flammable gas or ignitable substances are present. There are risks of igniting these substances and exploding by an arcing.

WARNING

- Do not touch this product or its internal components while circuit is live, or shortly after shutdown. There may be high voltage or high temperature present and you may receive an electric shock or burn.
- While this product is operating, keep your hands and face away from it as you may be injured by an unexpected situation.
- Do not make unauthorized changes to this product, otherwise you may receive an electric shock and void your warranty.
- Do not drop or insert anything into this product. It might cause a failure, fire and electric shock.
- Do not use this product under unusual condition such as emission of smoke or abnormal smell and sound etc. It might lead to fire and electric shock. In such cases, please contact us. Do not attempt repair by yourself, as it is dangerous for the user.
- Do not operate these products in the presence of condensation. It might lead fire and electric shock.

CAUTION

- This power supply is designed and manufactured for use within an end product such that it is accessible to SERVICE ENGINEERS only.
- Confirm connections to input/output terminals and signal terminal are correct as indicated in the instruction manual before switching on.
- Input voltage, Output current, Output power, ambient temperature and ambient humidity should be kept within specifications, otherwise the product will be damaged.
- Do not operate and store this product in an environment where condensation might occur. In such case, waterproof treatment is necessary.
- Do not use this product in environment with a strong electromagnetic field, corrosive gas or conductive substances.
- For applications, which require very high reliability (Nuclear related equipment, medical equipment, traffic control equipment, etc.), it is necessary to provide a fail-safe mechanism in the end equipment.
- Do not inject abnormal voltages into the output or signal of this product. The injection of reverse voltage or over voltage exceeding nominal output voltage into the output or signal terminals might cause damage to internal components.
- Never operate the product under over current or short-circuit conditions, or outside its specified Input Voltage

Range.

Insulation failure, smoking, burning or other damage may occur.

- This product contains a printed circuit board utilizing surface mounted devices. PCB stress such as bending, twisting etc. could cause damage. Therefore, please handle with care.
- This power supply has possibility that hazardous voltage may occur in output terminal depending on failure mode. The output of these products must be protected in the end use equipment to maintain SELV.
- The information in this document is subject to change without prior notice. Please refer to the latest version of the data sheet, etc., for the most up-to date specifications of the product.
- No part of this document may be copied or reproduced in any form without prior written consent of TDK-Lambda.

Notes for HWS-A/ME

NOTES

- The product should be completely enclosed in the application according to the specifications, and contact to the I/O part with the patient be limited. Be careful when designing the outline. Please refer to section 16, IEC/EN/UL60601-1.
- This product is not suitable for the use of the combustible narcotic that oxygen or the nitrous oxide mixed.
- The signal port connects only the device that suits IEC/EN/UL60601-1.
- It is necessary to fuse it in two poles of the main power supply in the overall equipment into which this product is built excluding the permanent installation type equipment defined by IEC/EN/UL60601-1 section 57.6. The fuse is installed in the monopole of the input of this product (live line).
- Between I/O of this product is evaluated as the basic insulation by IEC/EN/UL60601-1. Please add further insulation for safe contact to the output part.
- This product is compatible with MOOP (operator protection means). It does not correspond to patient protection means (MOPP).
- If you want to include this product in medical equipment, it must be fitted with a device to disconnect the input to the two poles of this product.
- Please refer to local regulations for the disposal of the product that passes the life.

Note : CE MARKING

CE Marking when applied to a product covered by this handbook indicates compliance with the low voltage directive (2006/95/EC) in that it complies with EN60950-1.

1. Model name identification method

HWS 15A - 5 / □

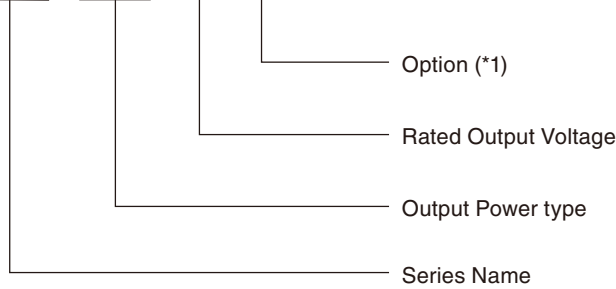

- (*1) Blank : Open frame type. (Standard)
- /A : With cover type
- /R : Open frame type with remote ON/OFF control model.(*2)
- /RA : Remote ON/OFF control,with cover.(*2)
- /ADIN : DIN rail mountable (Only cover type of 24V)
- /B : Connector type.(*2) (100A,150A : Only 12-48V output model)
- (*2) Option of HWS50A,80A,100A,150A

2. Terminal Explanation

HWS15A, HWS30A, HWS50A

HWS50A/B

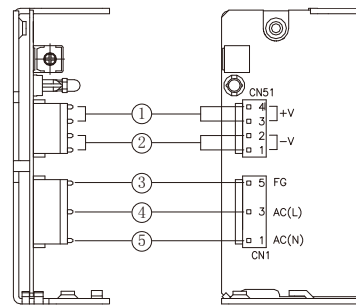
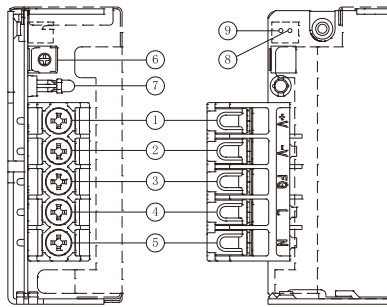

- ① +V : + Output terminal (15A max. / terminal)
- ② -V : -Output terminal (15A max. / terminal)
- ③ FG : Frame Ground
- ④ L : Input terminal Live line (Fuse in line)
- ⑤ N : Input terminal Neutral line
- ⑥ Output voltage adjustment trimmer
- ⑦ Output monitoring indicator (Green LED)
- * All screws size is M3.5

- ① +V : + Output terminal (5A max. / pin)
- ② -V : -Output terminal (5A max. / pin)
- ③ FG : Frame Ground
- ④ L : Input connector Live line (Fuse in line)
- ⑤ N : Input connector Neutral line

HWS50A/R (/RA Include)

- ⑧ -R : Remote ON/OFF control
- ⑨ +R : Remote ON/OFF control

* Connector (JST) for Remote ON/OFF control

| Connector | Housing | Terminal Pin |
|-----------|---------|--------------------------------|
| B2B-XH-AM | XHP-2 | BXH-001T-P0.6 or SXH-001T-P0.6 |

Hand Crimping Tool : YC-110R (JST) or YRS-110 (JST)
 Use recommended crimping tool.
 Matching housing and terminal pin — Not included with the product.

* Connector (JST) for CN1,CN51

| | Connector | Housing | Terminal Pin |
|-------------------------|-----------------|---------|------------------------------|
| CN1 : Input connector | B3P5-VH(LF)(SN) | VHR-5N | BVH-21T-P1.1 or SVH-21T-P1.1 |
| CN51 : Output connector | B4P-VH(LF)(SN) | VHR-4N | |

The recommended wire type : AWG18-22

Note: Up to 3A/pin : AWG18-22

Up to 5A/pin : AWG18-20

Hand Crimping Tool : YC-160R (JST)

Use recommended crimping tool.

Matching housing and terminal pin — Not included with the product.

HWS80A, HWS100A, HWS150A

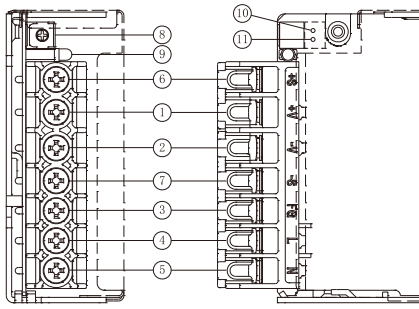

- ① +V : + Output terminal
(30A max. / terminal)
 - ② -V : - Output terminal
(30A max. / terminal)
 - ③ FG : Frame Ground
 - ④ L : Input terminal Live line (Fuse in line)
 - ⑤ N : Input terminal Neutral line
 - ⑥ +S : + Remote sensing terminal
 - ⑦ -S : - Remote sensing terminal
 - ⑧ Output voltage adjustment trimmer
 - ⑨ Output monitoring indicator (Green LED)
- * All screws size is M3.5

HWS80A/R, HWS100A/R, HWS150A/R (/RA Include)

- ⑩ -R : Remote ON/OFF control
- ⑪ +R : Remote ON/OFF control

* Connector (JST) for Remote ON/OFF control

| Connector | Housing | Terminal Pin |
|-----------|---------|--------------------------------|
| B2B-XH-AM | XHP-2 | BXH-001T-P0.6 or SXH-001T-P0.6 |

Hand Crimping Tool : YC-110R (JST) or YRS-110 (JST)

Use recommended crimping tool.

Matching housing and terminal pin — Not included with the product.

HWS80A/B, HWS100A/B, HWS150A/B

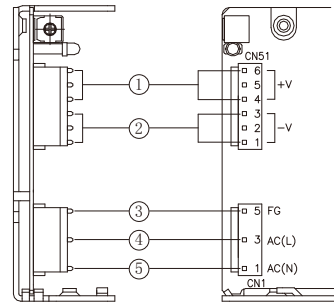

- ① +V : + Output terminal
(5A max. / pin)
- ② -V : - Output terminal
(5A max. / pin)
- ③ FG : Frame Ground
- ④ L : Input connector Live line (Fuse in line)
- ⑤ N : Input connector Neutral line

* Connector (JST) for CN1, CN51

| | Connector | Housing | Terminal Pin |
|-------------------------|-----------------|---------|-----------------|
| CN1 : Input connector | B3P5-VH(LF)(SN) | VHR-5N | BVH-21T-P1.1 |
| CN51 : Output connector | B6P-VH(LF)(SN) | VHR-6N | or SVH-21T-P1.1 |

The recommended wire type : AWG18-22

Note: Up to 3A/pin : AWG18-22

Up to 5A/pin : AWG18-20

Hand Crimping Tool : YC-160R (JST)

Use recommended crimping tool.

Matching housing and terminal pin — Not included with the product.

3. Connecting method

UNIT ·
PC Board

Pay attention to the input wiring. If it is connected to wrong terminal, the power supply will be damaged.

- Input must be off when making connections.
- Connect FG terminal to earth (frame ground of the equipment etc.) by thick wire for safety and improvement of noise sensitivity.

HWS15A, HWS30A, HWS50A

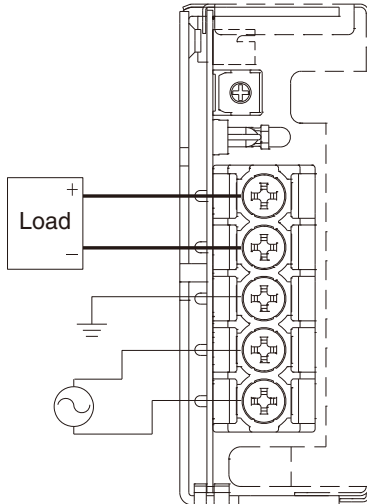

HWS80A, HWS100A, HWS150A

- Basic connection (Local sensing)
Connect "+S" terminal to "+V" terminal, and "-S" terminal to "-V" terminal with the attached short pieces .
(Short pieces are mounted at time of shipment.)

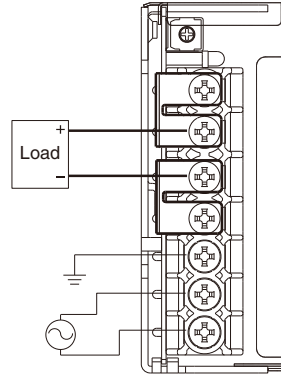

- Remote sensing connection
Connect "+S" terminal to "+" terminal of load, and "-S" terminal to "-" terminal of load with wires. If remote sensing terminals are opened, the output will rise and OVP may be triggered.

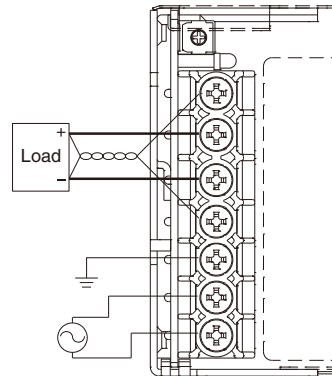

Recommended torque : HWS15A - HWS150A M3.5 screw
1.0N·m(10.2kgf·cm) - 1.6N·m(16.3kgf·cm)

HWS-A
取扱説明

4. Explanation of Functions and Precautions

1. Input Voltage Range

Input voltage range is single phase 85-265VAC(47-63Hz) or 20-370VDC. Input voltage, which is out of specification, might lead unit damage. For cases where conformance to various safeties required, described as 100-240VAC (50-60Hz).

Note : HWS-A series is able to withstand input of 300VAC for 5 seconds (No damage). Please note that to satisfy the electrical characteristics, the input voltage range must be within 85-265VAC

2. Output Voltage Range

Output voltage is set the rated value at shipment. V.ADJ trimmer can adjust the output voltage within the range.

Output voltage range is within $\pm 20\%$ (3.3V : $+20\%/ -10\%$, 48V : $+10\%/ -20\%$) of nominal output voltage.

To turn the trimmer clockwise, the output voltage will be increased. Take note when the output voltage is increased excessively, over voltage protection (OVP) function may trigger and voltage will be shut down. Furthermore, when increasing the output voltage reduce the output current so as not to exceed the maximum output power.

3. Inrush Current

This series equipped Power thermistor to limit the inrush current. This series are Power thermistor method so that higher current will flow at higher ambient temperature or re-input condition. Please select input switch and fuse carefully with the high temperature and re-input the power condition. The inrush current value is under cold start at 25°C in the specification.

4. Over Voltage Protection (OVP)

The OVP function (Inverter shut down method, manual reset type) is provided. OVP function operates within 3.3V: 125% - 150%, 5-24V: 125% - 145%, 48V: 115%-135% of nominal output voltage.

When OVP triggers, the output will be shut down. To reset OVP, remove the input of power supply for a few minutes, and then re-input. In addition, the setting value of OVP is fixed and not adjustable. Pay attention not to apply higher voltage externally to the output terminal to avoid unit failure. In case of inductive load, put protective diode in series to the output power line.

5. Over Current Protection (OCP)

HWS15A, HWS30A, HWS50A : Fold back limit and Hiccup mode with automatic recovery.

HWS80A, HWS100A, HWS150A : Constant current limit and Hiccup with automatic recovery.

OCP function operates when the output current exceeds 105% of maximum DC output current of specification.

The outputs will be automatically recovered when the overload condition is canceled. Never operate the unit under over current or shorted conditions, which may leads damage. OCP setting is fixed and not to be adjusted externally.

• All specifications are subject to change without notice.

6. Remote Sensing (+S, -S terminal)

(For HWS80A, HWS100A, HWS150A)

This function compensates voltage drop of wiring from output terminals to load terminals. Connect "+S" terminal to "+" terminal of load and "-S" terminal to "-" terminal of load with sensing wires.

The total line voltage drop (+ side line and - side line) shall be less than 0.3V.

In case that sensing line is too long, it is necessary to put an electrolytic capacitor in following 3 placed;

- 1) Across the load terminal,
- 2) Between "+S" terminal and "+V" terminal,
- 3) Between "-S" terminal and "-V" terminal.

If remote sensing terminal is opened, the output will rise and OVP may be triggered.

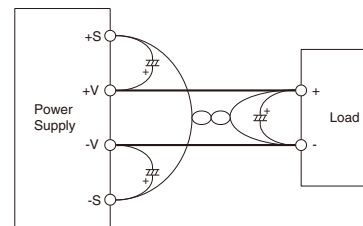

7. Output Ripple & Noise

The standard specification for maximum ripple value is measured according to measurement circuit specified by JEITA RC-9131B. When load lines are longer, ripple will become larger. In this case, electrolytic capacitor, film capacitor, etc.

might be necessary to use across the load terminal.

The output ripple cannot be measure accurately if the probe ground lead of oscilloscope is too long.

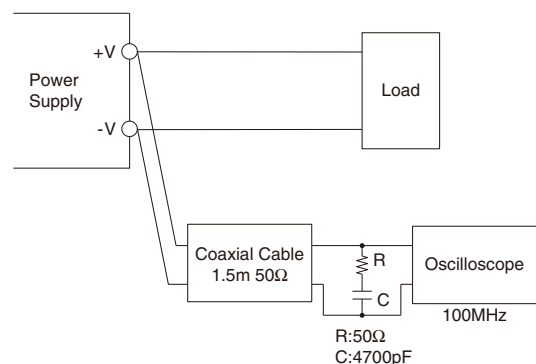

8. Series Operation

For series operation, either method (A) or (B) is possible.

(A)

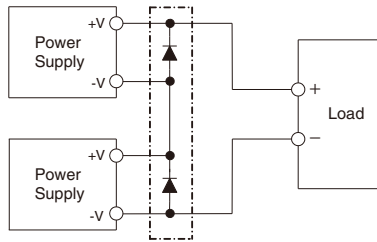

Note : In case of (A).please connect bypass diodes to prevent reverse voltage.

Please select a bypass diode with maximum forward current rating more than output load current.

And maximum reverses voltage must withstand each power supply output voltage.

*Series operation for HWS80A, HWS100A, HWS150A possible without bypass diode.

Never use when one of the unit not operate, which may leads damage.

(B)

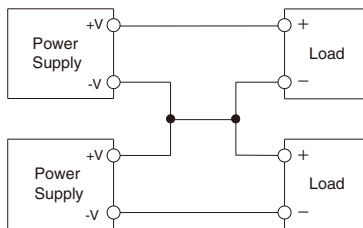

9. Parallel Operation

(A) Operation to increase the Output Current is not possible.

(B) Operation as a Backup Power Supply is possible as follows.

1. Set the power supply output voltage higher by the amount of forward voltage drop (VF) of the diode.
2. Please adjust the output voltage of each power supply to be the same.
3. Please use within the specifications for output voltage and output power.
4. Please select a reverse current prevention diode with maximum forward current rating more than output load current.

(A)

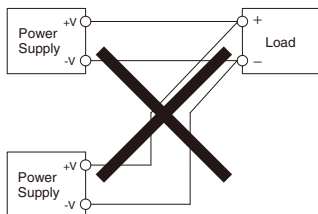

(B)

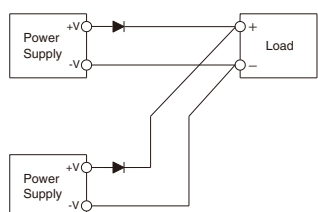

10. Isolation Test

Isolation resistance between Output . FG terminal is more than 100MΩat 500VDC. For safety operation, voltage setting of DC isolation tester must be done before the test. Ensure that the unit is fully discharged after the test.

■Output - FG terminal : 500VDC More than 100MΩ

(A)HWS15A,HWS30A

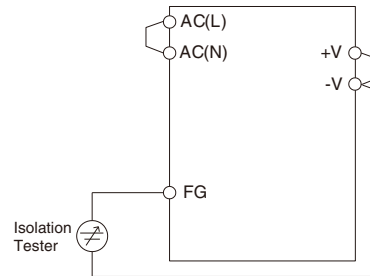

(B)HWS50A

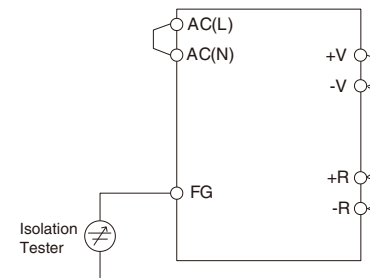

(C)HWS80A,HWS100A,HWS150A

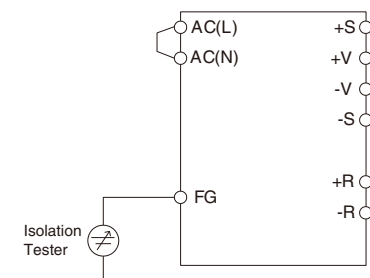

Withstand Voltage

This series is designed to withstand 3.0kVAC between input and output, 2.0kVAC between input and FG and 500VAC between output and FG each for 1 minute. When testing withstand voltage, set current limit of withstand voltage test equipment at 20mA. The applied voltage must be gradually increased from zero to testing value and then gradually decreased for shut down. When timer is used, the power supply may be damaged by high impulse voltage at timer switch on and off. Connect input and output as follows.

- Input - FG (solid line) : 2.0kVAC, 1min (20mA)
 - Input - Output (dotted line) : 3.0kVAC, 1min (20mA)
- (A) HWS15A, HWS30A

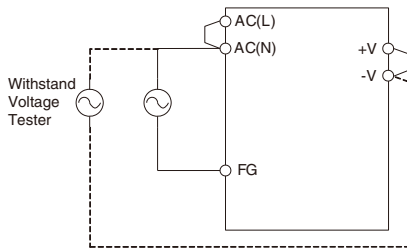

(B) HWS50A

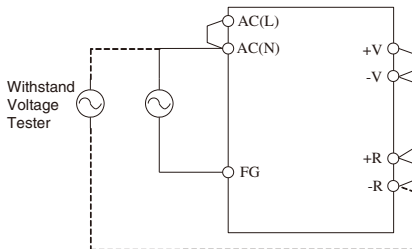

(C) HWS80A, HWS100A, HWS150A

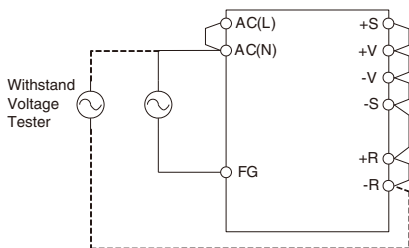

- Output - FG : 500VAC, 1min (20mA)
- (A) HWS15A, HWS30A

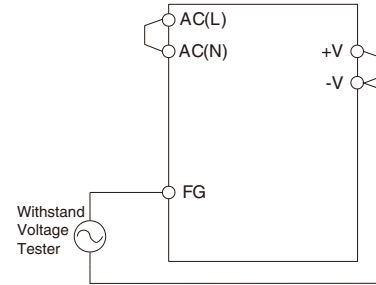

(B) HWS50A

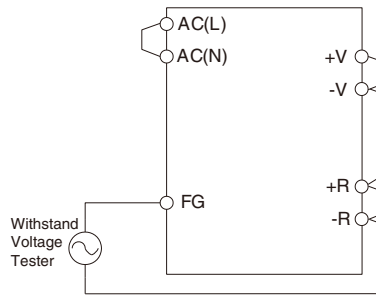

(C) HWS80A, HWS100A, HWS150A

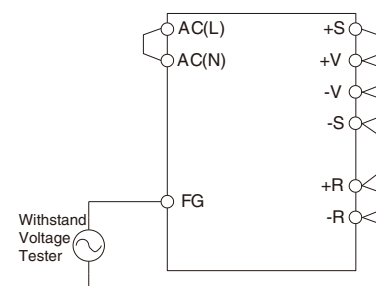

- Note1 : This product have monolithic ceramic capacitor in secondary circuit to frame ground. Some of the withstand voltage tester may generate high voltage at the matching with monolithic ceramic capacitor and may cause the unit damage. So, please check the waveform of test voltage.
- Note2 : In case of using external noise filter, capacitance between "Input and FG" might be increased. When testing withstand voltage between "Input and Output", there is a possibility exceeding withstand voltage between "Output and FG" (500VAC). Please check the voltage between "Output and FG" . If the voltage exceeding withstand voltage, please add external capacitor to "Output and FG" . It can decrease the voltage. On the other hand, no need to check the voltage in case of "Output and FG" is shorted.

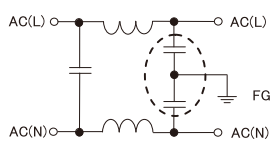

The example of noise filter circuit that may increasing capacitance value between "Input and FG" (Capacitance value in dashed line is added.)

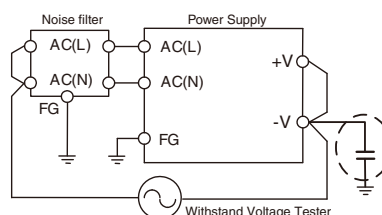

External capacitor adding point or short point. Even in the case of "+V and FG", There is a similar effect.

12. Remote ON/OFF Control (HWS50A-150A Option)

Remote ON/OFF control function is available as option with model name followed by /R.

Using this function allows the user to turn the output on and off without having to turn the AC input off and on.

It is controlled by the voltage applied to +R and -R. This circuit is in the Secondary side of the power supply unit.

Do not connect in the primary side of power supply unit.

And this circuit is isolated from the output of power supply unit.

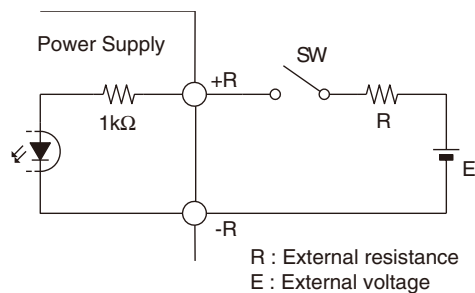

| +R & -R terminal condition | Output condition |
|----------------------------|------------------|
| SW ON (Higher than 4.5V) | ON |
| SW OFF (Lower than 0.8V) | OFF |

| External voltage : E | External resistance : R |
|----------------------|-------------------------|
| 4.5 ~ 12.5VDC | No required |
| 12.5 ~ 24.5VDC | 1.5kΩ |

5. Mounting Method

1. Mounting Method

- (1) This is convection cooling type power supply. In the consideration for the heat radiation and safety. Please take a distance more than 15mm between the power supply and the peripheral parts. When lining up multiple units, please make sure to place them 15mm or more apart from each other.
- (2) Please take insulation distance (space) more than 5mm for the component side at the open frame type.
- (3) The maximum allowable penetration of mounting screws is 6mm.
- (4) Recommended torque for mounting screw
HWS15A-150A (M3 screw) : 0.49N · m (5.0 kgf · cm)

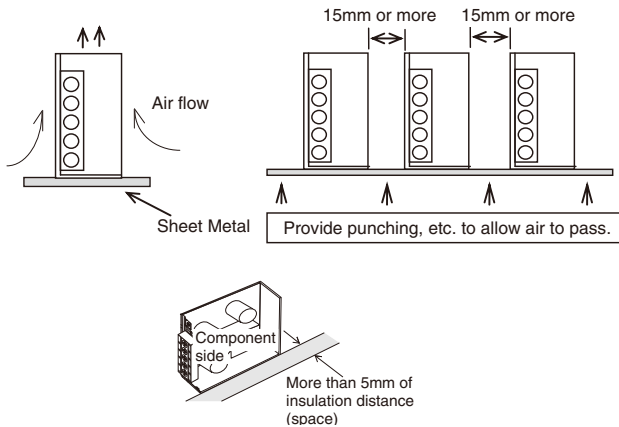

2. Output Derating according to the Mounting Directions

Recommend standard mounting is direction (A). Direction (B), (C) and (D) are also possible. For other mounting directions, please inquire to TDK-Lambda. Refer to the derating below. Please do not use mounting direction (E), where the PCB will be on the topside and heat will be trapped inside the unit. Load (%) is percent of maximum output power or maximum output current, do not exceed its derating of maximum load.

Mounting direction

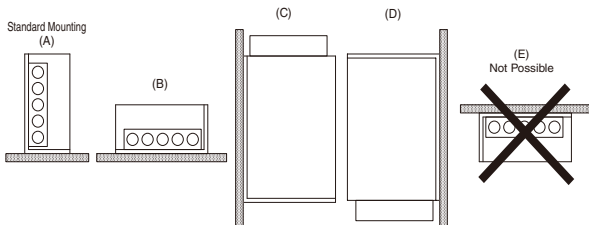

Output Derating

HWS15A

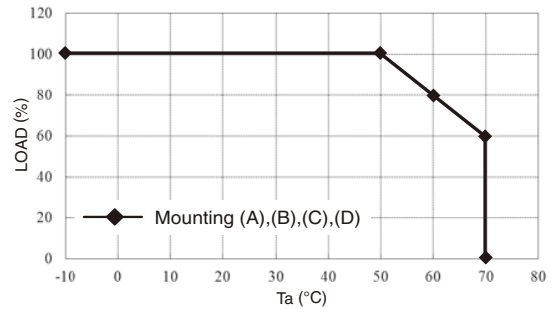

| Ta(°C) | Load (%) |
|---------|--------------------------|
| | Mounting (A),(B),(C),(D) |
| -10~+50 | 100 |
| 60 | 80 |
| 70 | 60 |

HWS30A

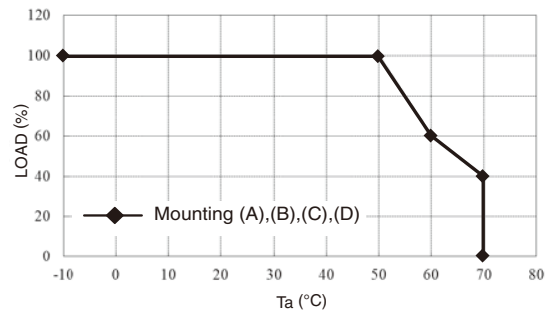

| Ta(°C) | Load (%) |
|---------|--------------------------|
| | Mounting (A),(B),(C),(D) |
| -10~+50 | 100 |
| 60 | 60 |
| 70 | 40 |

HWS50A

(Include option model /R, /B)

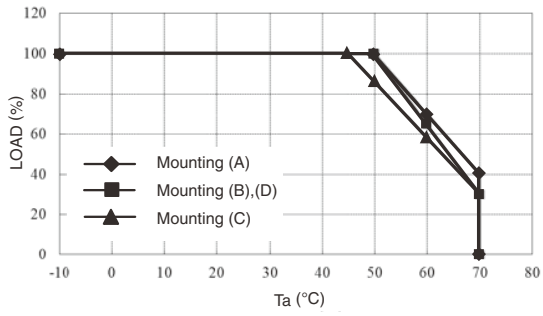

| Ta(°C) | Load (%) | | |
|---------|--------------|------------------|--------------|
| | Mounting (A) | Mounting (B),(D) | Mounting (C) |
| -10~+45 | 100 | 100 | 100 |
| 50 | 100 | 100 | 86 |
| 60 | 70 | 65 | 58 |
| 70 | 40 | 30 | 30 |

HWS100A

(Include option model /R, /B)

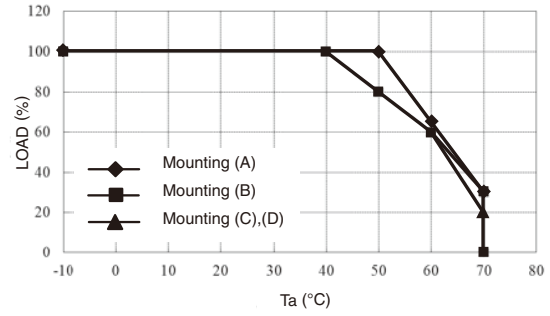

| Ta(°C) | Load (%) | | |
|---------|--------------|--------------|------------------|
| | Mounting (A) | Mounting (B) | Mounting (C),(D) |
| -10~+40 | 100 | 100 | 100 |
| 50 | 100 | 80 | 80 |
| 60 | 65 | 60 | 60 |
| 70 | 30 | 30 | 20 |

HWS80A

(Include option model /R, /B)

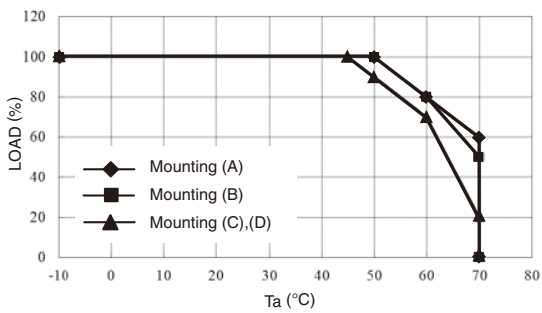

| Ta(°C) | Load (%) | | |
|---------|--------------|------------------|--------------|
| | Mounting (A) | Mounting (B),(D) | Mounting (C) |
| -10~+45 | 100 | 100 | 100 |
| 50 | 100 | 100 | 90 |
| 60 | 80 | 80 | 70 |
| 70 | 60 | 50 | 20 |

HWS150A

(Include option model /R, /B)

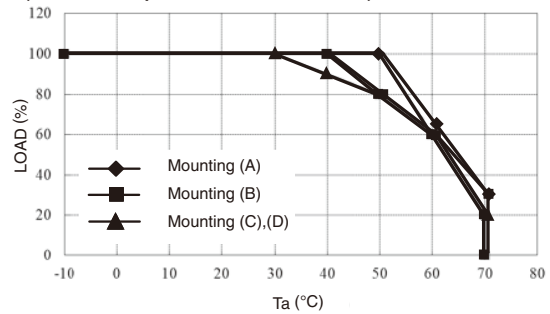

| Ta(°C) | Load (%) | | |
|---------|--------------|--------------|------------------|
| | Mounting (A) | Mounting (B) | Mounting (C),(D) |
| -10~+30 | 100 | 100 | 100 |
| 40 | 100 | 90 | 90 |
| 50 | 100 | 80 | 80 |
| 60 | 60 | 60 | 60 |
| 70 | 20 | 20 | 20 |

HWS15A/A (With cover type)

(Include option model /ADIN)

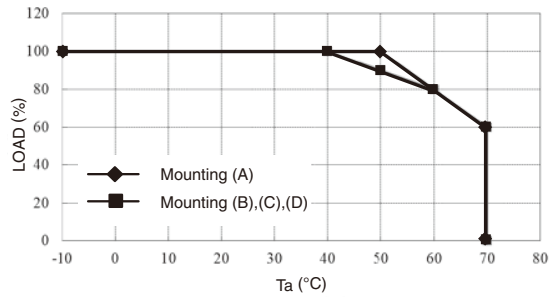

| Ta(°C) | Load (%) | |
|---------|--------------|----------------------|
| | Mounting (A) | Mounting (B),(C),(D) |
| -10~+40 | 100 | 100 |
| 50 | 100 | 90 |
| 60 | 80 | 80 |
| 70 | 60 | 60 |

HWS50A/A (With cover type)

(Include option model /RA,/ADIN)

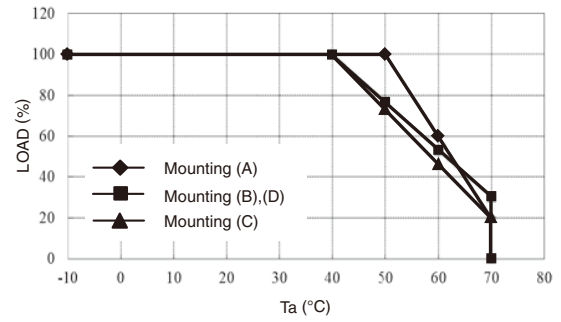

| Ta(°C) | Load (%) | | |
|---------|--------------|------------------|--------------|
| | Mounting (A) | Mounting (B),(D) | Mounting (C) |
| -10~+40 | 100 | 100 | 100 |
| 50 | 100 | 76 | 73 |
| 60 | 60 | 53 | 46 |
| 70 | 20 | 30 | 20 |

HWS30A/A (With cover type)

(Include option model /ADIN)

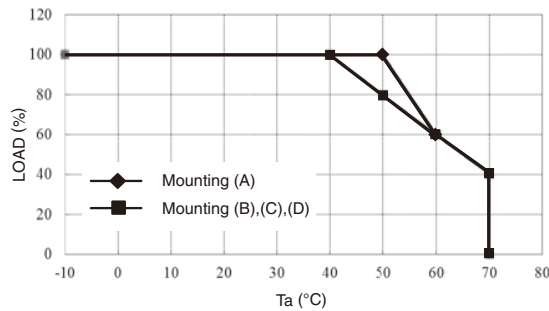

| Ta(°C) | Load (%) | |
|---------|--------------|----------------------|
| | Mounting (A) | Mounting (B),(C),(D) |
| -10~+40 | 100 | 100 |
| 50 | 100 | 80 |
| 60 | 60 | 60 |
| 70 | 40 | 40 |

HWS80A/A (With cover type)

(Include option model /RA,/ADIN)

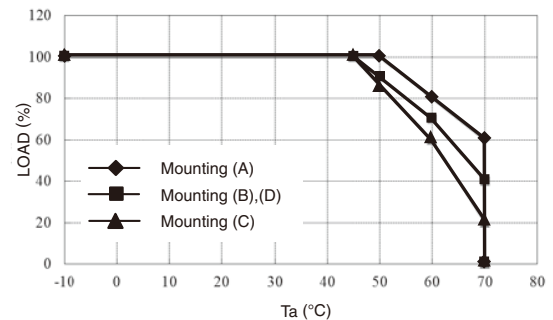

| Ta(°C) | Load (%) | | |
|---------|--------------|------------------|--------------|
| | Mounting (A) | Mounting (B),(D) | Mounting (C) |
| -10~+45 | 100 | 100 | 100 |
| 50 | 100 | 90 | 86 |
| 60 | 80 | 70 | 60 |
| 70 | 60 | 40 | 20 |

HWS100A/A (With cover type) (Include option model /RA,/ADIN)

* Refer to dotted line for output derating curve, when input voltage range is "85VAC ≤ Vin < 90VAC" for the Mounting (A).

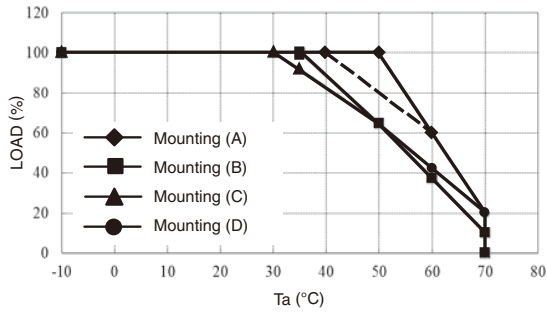

| Ta(°C) | Load (%) | | | |
|---------|--------------|--------------|--------------|--------------|
| | Mounting (A) | Mounting (B) | Mounting (C) | Mounting (D) |
| -10~+30 | 100 | 100 | 100 | 100 |
| 35 | 100 | 100 | 92 | 100 |
| 50 | 100 | 65 | 65 | 65 |
| 60 | 60 | 37 | 37 | 42 |
| 70 | 20 | 10 | 10 | 20 |

HWS150A/A (With cover type)

(Include option model /RA,/ADIN)

* Refer to dotted line for output derating curve, when input voltage range is "85VAC ≤ Vin < 90VAC" for the Mounting (A).

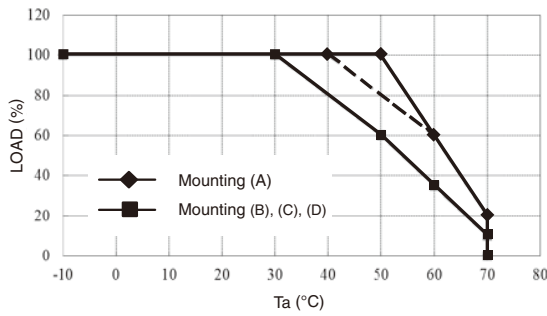

| Ta(°C) | Load (%) | |
|---------|--------------|----------------------|
| | Mounting (A) | Mounting (B),(C),(D) |
| -10~+30 | 100 | 100 |
| 50 | 100 | 60 |
| 60 | 60 | 35 |
| 70 | 20 | 10 |

6. Wiring Method

- (1) The output load line and input line shall be separated, and use all lines as thick and short as possible to make lower impedance. The output load line and input line shall be twisted or use shielded wire to improve noise sensitivity.
- (2) Remote sensing lines and remote ON/OFF control lines shall be twisted or use shielded wire, and separated from the output lines.
- (3) Noise can be eliminated by attaching a capacitor to the load terminals.
- (4) The recommended wire type, torque and crimp-type terminal :

| MODEL | Recommended Wire | Recommended torque | Recommended crimp-type terminal | | |
|-------------------|------------------|--|---------------------------------|---------|-----------------------|
| | | | D (MAX) | t (MAX) | Mounting pieces (MAX) |
| HWS15A-50A | AWG14-22 | All terminal M3.5 Screws 1.0N·m(10.2kgf·cm) ~ 1.6N·m(16.3kgf·cm) | 6.8mm | 0.8mm | 2piece |
| HWS80A HWS100A | AWG12-22 | Output terminal M3.5 Screws 1.0N·m(10.2kgf·cm) ~ 1.6N·m(16.3kgf·cm) | 8.1mm | 1.0mm | 1piece |
| | AWG14-22 | Other terminal M3.5 Screws 1.0N·m(10.2kgf·cm) ~ 1.6N·m(16.3kgf·cm) | | 0.8mm | 2piece |
| HWS150A | AWG10-22 | Output terminal M3.5 Screws 1.0N·m(10.2kgf·cm) ~ 1.6N·m(16.3kgf·cm) | 8.1mm | 1.0mm | 1piece |
| | AWG14-22 | Other terminal M3.5 Screws 1.0N·m(10.2kgf·cm) ~ 1.6N·m(16.3kgf·cm) | | 0.8mm | 2piece |

Note 1 : When using separate loads, use of two pcs. of 0.8mm thick crimp-type terminal is recommended.

Note 2 : For recommended diameter, refer to wire maker recommended allowable current and voltage drop.

Especially, for 3V or 5V models, output current is large. Thick diameter wire is recommended.

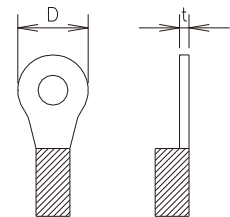

7. The life expectancy

The life of the power supply depends on the life of the built-in aluminum electrolytic capacitor. The life is described in reliability data.

The life of the aluminum electrolytic capacitor varies depending on the method of mounting the power supply, the load current, and the ambient temperature. Please refer to "Electrolytic Capacitor Lifetime".

Please do not use the product which passed over the life expectancy. There is a risk of unexpected output shutdown and specifications may not be satisfied.
Please contact us for maintenance or exchange the product which passed over the life expectancy.

8. External Fuse Rating

Refer to the following fuse rating when selecting the external input fuse.
Surge current flows when input turn on. Use slow-blow fuse or time-lag fuse. Fast-blow fuse can not be used.
Fuse rating is specified by inrush current value at input turn on. Do not select the fuse according to actual input current (rms.) values.

HWS15A : 2A
HWS30A-100A : 3.15A
HWS150A : 5A

9. Before concluding that the unit is at fault...

Before concluding that the unit is at fault, make the following checks.

- (1) Check if the rated input voltage is connected.
- (2) Check if the wiring of input and output is correct.
- (3) Check if the wire size is not too thin.
- (4) Check if the output voltage control (V.ADJ) is properly adjusted.
- (5) Check if the remote sensing terminal is not opened. The output will rise and OVP may be triggered.
- (6) Check if the output current and output power does not over specification.

- (7) Audible noise can be heard when input voltage waveform is not sinusoidal wave.
- (8) Audible noise can be heard during Dynamic-Load operation.
- (9) Ensure that a large capacitor is not connected on the output side.
Please use within maximum capacitance shown below.
If connecting more than the following capacity, conditioning is needed. Please contact us for details

| MODEL | Maximum external capacitance | | | | | |
|------------------------|------------------------------|----|---------|---------|---------|---------|
| | 3.3V | 5V | 12V | 15V | 24V | 48V |
| HWS15A | 10,000uF | | 5,000uF | 2,000uF | 1,000uF | 500uF |
| HWS30A,HWS50A | 10,000uF | | 5,000uF | | 2,000uF | 500uF |
| HWS80A,HWS100A,HWS150A | 10,000uF | | | | 5,000uF | 1,000uF |

10. Warranty Period

This product is warranted for a period of 5 years from the date of shipment.
For damages occurring at normal operation within this warranty period, repair is free of charge.
Please read the General Safety Instruction before using the products.

TDK·Lambda

TDK·Lambda

TDK·Lambda

TDK·Lambda

TDK·Lambda

Catalog Usage Precautions

Please observe the following points when using this catalog for power supplies and related products of TDK-Lambda Corporation (hereafter referred to simply as "our products"). Be sure to carefully read all precautions stated below before beginning to use our products.

1. The contents of this catalog are subject to change without notice, for example related to product improvements and other instances. Always check the latest information before deciding on a product.
2. Our products are designed and manufactured under the assumption that they will be used as integrated power supplies for normal industrial applications. They are not designed and manufactured for use in high-safety applications (applications requiring very high reliability and safety levels, where a reliability or safety problem could directly involve the risk of serious injury or death). If the customer decides to use our products in a high-safety application, appropriate fail-safe design features must be provided (such as incorporating protective circuitry and/or protective equipment in the system, or incorporating redundancy in the system so that a single failure cannot lead to instability). TDK-Lambda Corporation does not assume liability for any claims or damages either by the customer or third parties arising from the use of our products for high-safety applications.
3. When designing equipment in which our products are to be used, as well as peripheral circuitry for such equipment, always observe the "Product Usage Precautions" noted in this catalog and/or the product documentation and ensure that maximum ratings, power supply voltage range, operation temperature range and other specifications are not exceeded. TDK-Lambda Corporation does not assume liability for any claims or damages arising from the use of our products in a way that exceeds specifications, or from a type of usage indicated as unsuitable for the respective product in this catalog.
4. The operation outline and usage descriptions given in this catalog are examples. Before actual use of a product, all external factors must be examined carefully in order to ensure appropriate circuit and implementation design. TDK-Lambda Corporation does not assume liability for any claims or damages arising from indirect problems such as EMI or mechanical effects from our products.
5. The technical information included in this catalog is intended only for the purpose of illustrating representative operation or application of our products. It does not imply any guarantee or granting of license for intellectual property rights or other rights held either by TDK-Lambda Corporation or third parties. TDK-Lambda Corporation does not assume liability for any problems with third parties related to intellectual property rights arising from the use of our products.
6. Products listed in this catalog may require export permission or authorization in compliance with the Foreign Exchange and Foreign Trade Act.
7. The contents of this catalog may not be reproduced or copied without permission by TDK-Lambda Corporation.
8. For any inquiries regarding this catalog, please contact the Sales Department of TDK-Lambda Corporation.

Please see the Web of relevant companies for latest updates.

*1. Note that the contents of this catalog may be changed without prior warning. Be sure to read catalogs and instruction manuals for each product before using them. For accuracy purposes, please ask for specifications, and check contents.

*2. All included company names, products names and service marks, etc., are the trademarks or registered trademarks of TDK, TDK-Lambda or their subsidiaries in Japan and other countries. Note that the registered mark ® or TM are not used in this material, excluding one section.

*3. The TDK logo is the registered trademark of TDK Corporation.



<http://www.tdk-lambda.com/>

TDK-Lambda Corporation

3-9-1, Shibaura, Minato-ku, Tokyo 108-0023, Japan

HWS-A_1503E