

Active Clamp Forward Converter with Synchronous Rectification

DESCRIPTION

Demonstration circuits 2324A-A, 2324A-B, and 2324A-C are active clamp forward converters with synchronous rectification featuring the [LT[®]3753](#).

These circuits were designed to demonstrate the high level of performance, efficiency and small solution size attainable using this part. They operate at 240kHz. The DC2324A-A produces a 24V/5A output from an input voltage range of 36V to 72V. The DC2324A-B produces a 24V/5A output from an input voltage range of 18V to 36V. The DC2324A-C produces a 24V/4A output from an input voltage range of 9V to 18V, making it suitable for telecom, industrial and other isolated power supply applications. They all have an eighth-brick footprint area. Synchronous rectification helps to attain efficiency exceeding 94% (exceeding 95% for the DC2324A-A and DC2324A-B).

The DC2324A circuits feature soft-start which prevents output voltage overshoot during startup or when recovering from an overload condition.

The DC2324A also has a precise overcurrent protection circuit that allows for continuous operation and low power dissipation during short circuit conditions which ensures high reliability.

Please refer to the LT3753 data sheet for design details and applications information.

Design files for this circuit board are available at <http://www.linear.com/demo/DC2324A>

LT, LT, LTC, LTM, Linear Technology and the Linear logo are registered trademarks of Linear Technology Corporation. All other trademarks are the property of their respective owners.

PERFORMANCE SUMMARY DC2324A-A

Specifications are at $T_A = 25^\circ\text{C}$

SYMBOL	PARAMETER	CONDITIONS	MIN	TYP	MAX	UNITS
V_{IN}	Input Supply Range		36		72	V
V_{OUT}	Output Voltage		21.6	24	26.4	V
I_{OUT}	Maximum Output Current, Continuous		5			A
f_{SW}	Switching (Clock) Frequency			240		kHz
$V_{OUT\ P-P}$	Output Ripple	$V_{IN} = 48\text{V}$, $I_{OUT} = 5\text{A}$ (20MHz BW)		40		mV _{P-P}
P_{OUT}/P_{IN}	Efficiency (see Figure 2)	$V_{IN} = 48\text{V}$, $I_{OUT} = 5\text{A}$		95.6		%

PERFORMANCE SUMMARY DC2324A-B

Specifications are at $T_A = 25^\circ\text{C}$

SYMBOL	PARAMETER	CONDITIONS	MIN	TYP	MAX	UNITS
V_{IN}	Input Supply Range		18		36	V
V_{OUT}	Output Voltage		21.6	24	26.4	V
I_{OUT}	Maximum Output Current, Continuous		5			A
f_{SW}	Switching (Clock) Frequency			240		kHz
$V_{OUT\ P-P}$	Output Ripple	$V_{IN} = 24\text{V}$, $I_{OUT} = 5\text{A}$ (20MHz BW)		30		mV _{P-P}
P_{OUT}/P_{IN}	Efficiency (see Figure 3)	$V_{IN} = 24\text{V}$, $I_{OUT} = 5\text{A}$		95.7		%

DEMO MANUAL DC2324A-A, DC2324A-B, DC2324A-C

PERFORMANCE SUMMARY DC2324A-C Specifications are at $T_A = 25^\circ\text{C}$

SYMBOL	PARAMETER	CONDITIONS	MIN	TYP	MAX	UNITS
V_{IN}	Input Supply Range		9		18	V
V_{OUT}	Output Voltage		21.6	24	26.4	V
I_{OUT}	Maximum Output Current, Continuous		4			A
f_{SW}	Switching (Clock) Frequency			240		kHz
$V_{OUT\ P-P}$	Output Ripple	$V_{IN} = 12\text{V}, I_{OUT} = 4\text{A}$ (20MHz BW)		30		mV _{P-P}
P_{OUT}/P_{IN}	Efficiency (see Figure 4)	$V_{IN} = 12\text{V}, I_{OUT} = 4\text{A}$		94.8		%

QUICK START PROCEDURE

Demonstration circuit 2324A is easy to set up to evaluate the performance of the LT3753. Refer to Figure 1 for proper measurement equipment setup and follow the procedure below:

1. Set an input power supply that is capable of covering the input voltage range of the DC2324A (see the Performance Summary table) to one of these voltages:
48V for the DC2324A-A,
24V for the DC2324A-B,
12V for the DC2324A-C.

Then turn off the supply.

2. With power off, connect the supply to the input terminals $+V_{IN}$ and $-V_{IN}$. If efficiency measurements are desired, an ammeter with proper rating can be put in series with the input supply in order to measure the DC2324A's input current.
3. Turn on the power at the input.

NOTE: Make sure that the input voltage does not exceed 100V.

4. Check for the proper output voltage of 24V. Turn off the power at the input.

5. Once the proper output voltage is established, connect a variable load capable of sinking 5A at 24V to the output terminals $+V_{OUT}$ and $-V_{OUT}$. Set the current for 0A.

- a. If efficiency measurements are desired, an ammeter that is capable of handling 5A_{DC} can be put in series with the output load in order to measure the DC2324A's output current.
- b. A voltmeter can be placed across the output terminals in order to get an accurate output voltage measurement.

6. Turn on the power at the input.

NOTE: If there is no output, temporarily disconnect the load to make sure that the load is not set too high.

7. Once the proper output voltage is again established, adjust the load within the operating range and observe the output voltage regulation, ripple voltage, efficiency and other desired parameters.

NOTE: When measuring the input or output voltage ripples, care must be taken to avoid a long ground lead on the oscilloscope probe. Measure the input or output voltage ripple by touching the probe tip directly across the $+V_{IN}$ and $-V_{IN}$, or $+V_{OUT}$ and $-V_{OUT}$ terminals.

QUICK START PROCEDURE

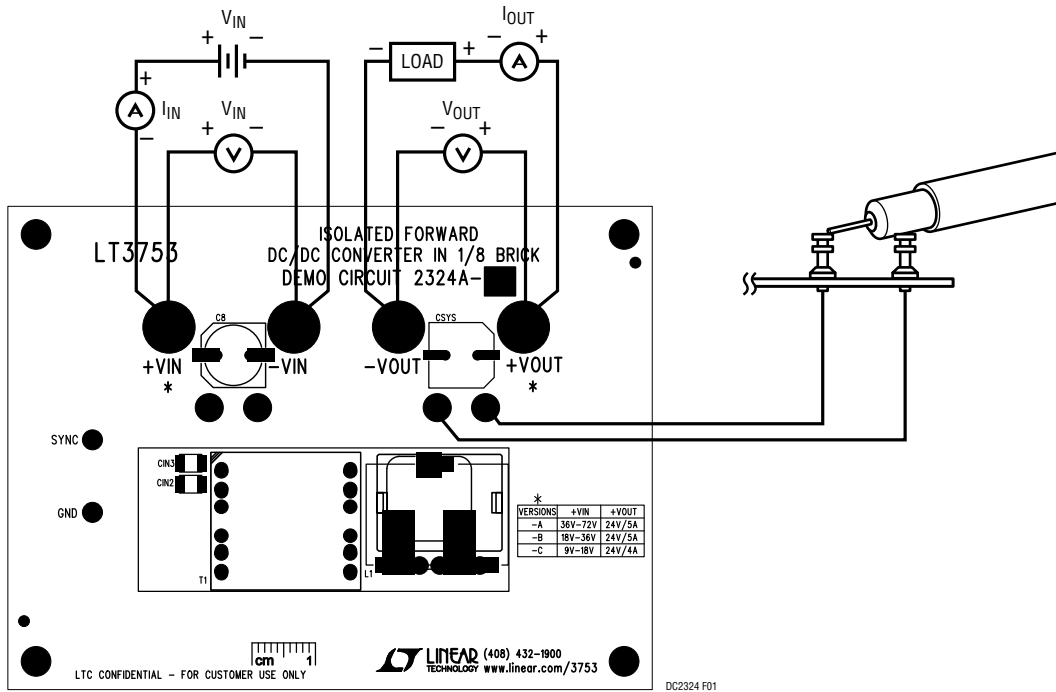

Figure 1. Proper Measurement Equipment Setup

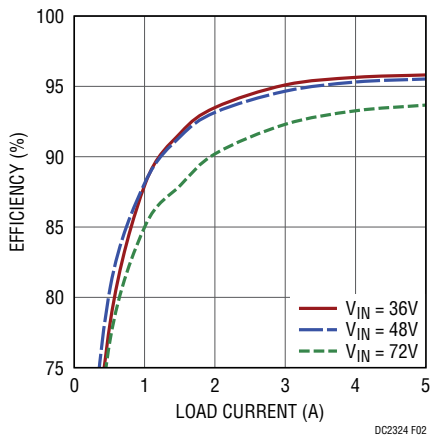

Figure 2. DC2324A-A Efficiency

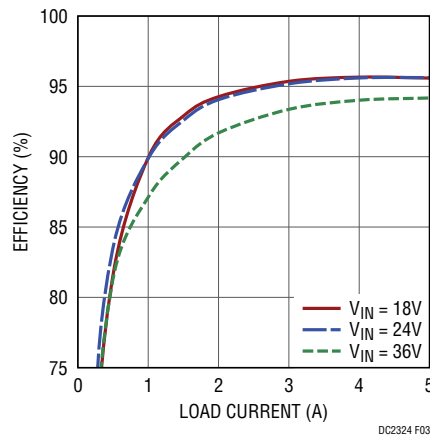

Figure 3. DC2324A-B Efficiency

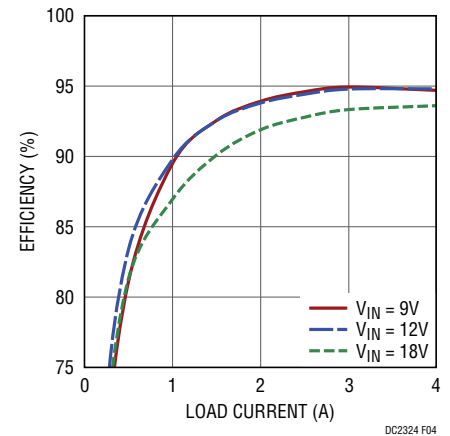

Figure 4. DC2324A-C Efficiency

QUICK START PROCEDURE

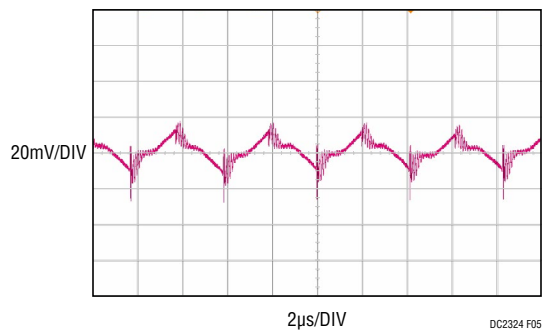

Figure 5. DC2324A-A Output Ripple at 48V_{IN} and 5A_{OUT} (20MHz BW)

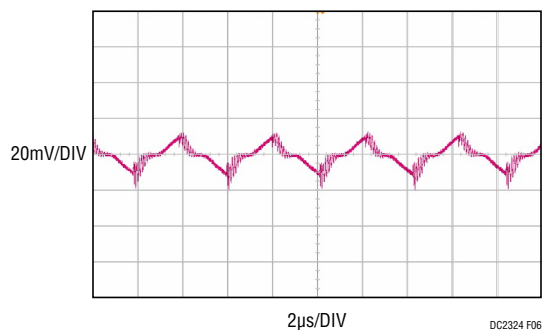

Figure 6. DC2324A-B Output Ripple at 24V_{IN} and 5A_{OUT} (20MHz BW)

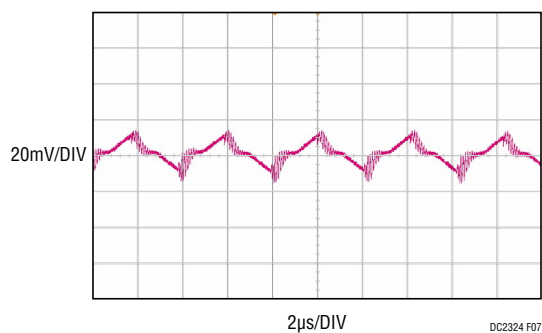

Figure 7. DC2324A-C Output Ripple at 12V_{IN} and 4A_{OUT} (20MHz BW)

QUICK START PROCEDURE

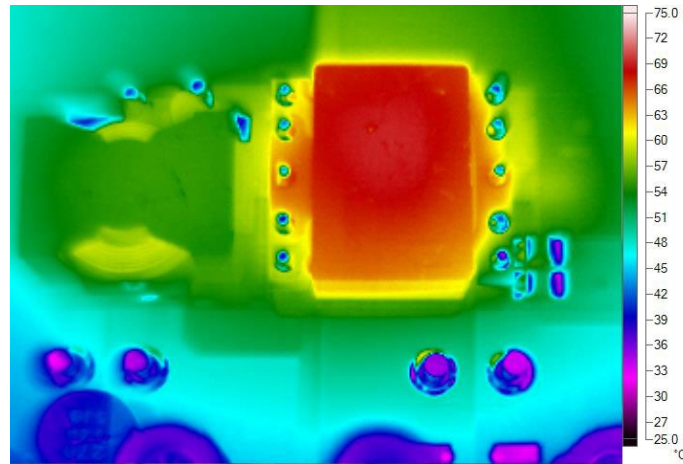

Figure 8. DC2324A-A Thermal Map, Front Side at 48V_{IN} and 5A_{OUT} (T_A = 25°C)

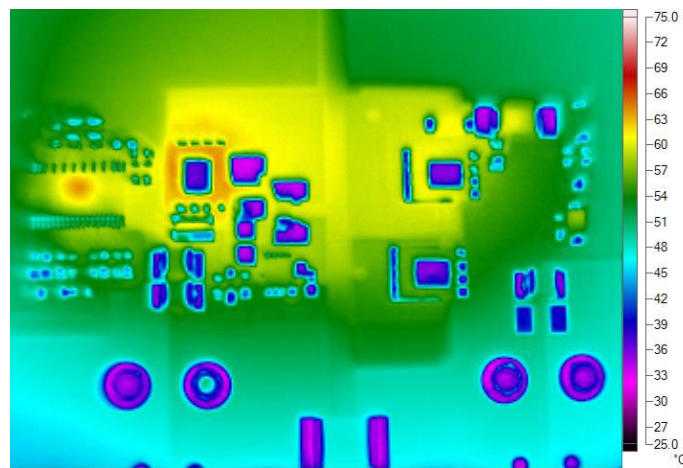

Figure 9. DC2324A-A Thermal Map, Back Side at 48V_{IN} and 5A_{OUT} (T_A = 25°C)

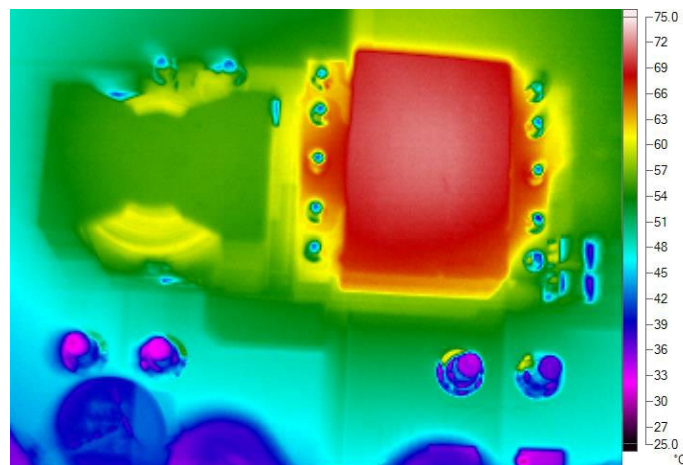

Figure 10. DC2324A-B Thermal Map, Front Side at 24V_{IN} and 5A_{OUT} (T_A = 25°C)

QUICK START PROCEDURE

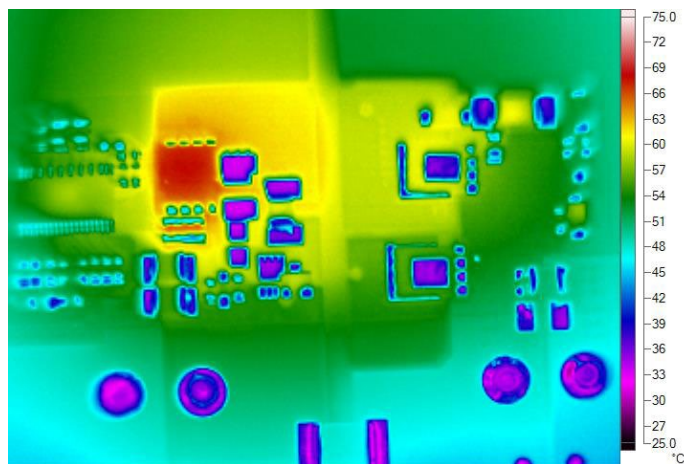

Figure 11. DC2324A-B Thermal Map, Back Side at 24V_{IN} and 5A_{OUT} (T_A = 25°C)

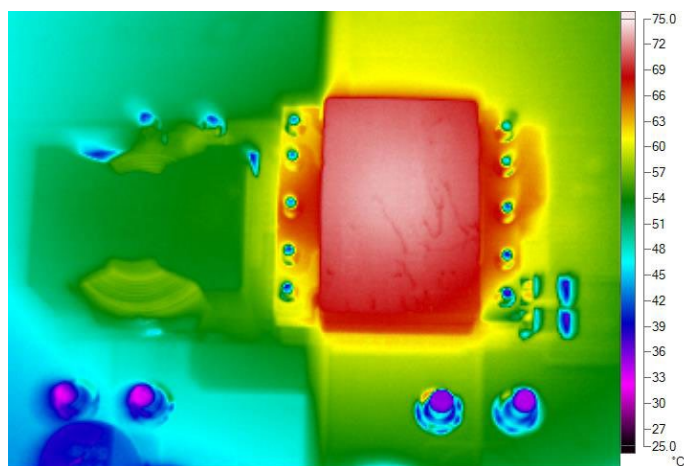

Figure 12. DC2324A-C Thermal Map, Front Side at 12V_{IN} and 4A_{OUT} (T_A = 25°C)

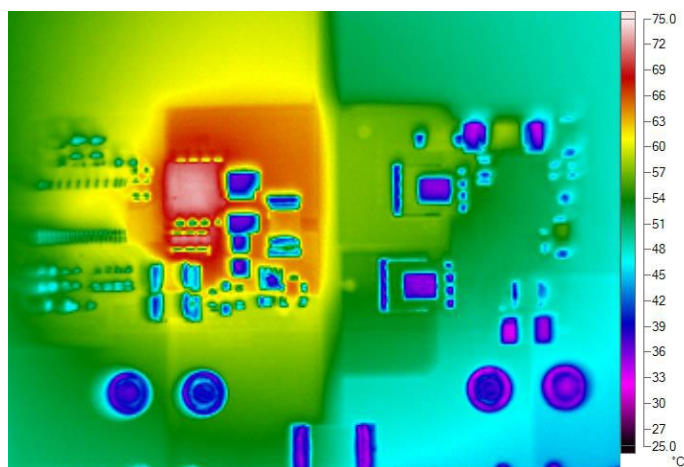

Figure 13. DC2324A-C Thermal Map, Back Side at 12V_{IN} and 4A_{OUT} (T_A = 25°C)

DEMO MANUAL DC2324A-A, DC2324A-B, DC2324A-C

PARTS LIST

ITEM	QTY	REFERENCE	PART DESCRIPTION	MANUFACTURER/PART NUMBER
Required Circuit Components for DC2324A-A, DC2324A-B, and DC2324A-C				
1	1	C01	CAP, X7R, 10 μ F, 50V, 10% 1210	MURATA, GRM32ER71H106KA12L
2	1	CSYS	CAP, ALUM., 270 μ F, 35V, G size	PANASONIC, EEHZA1V271P
3	1	CY1	CAP, X7R, 2200pF, 250V, 10% 2220	MURATA, GA355QR7GF222KW01L
4	3	C1, C3, C5	CAP, X7R, 0.1 μ F, 50V, 10% 0603	MURATA, GRM188R71H104KA93D
5	1	C2	CAP, X7R, 4.7 μ F, 25V, 10% 0805	MURATA, GRM21BR71E475KA73L
6	1	C4	CAP, X7S, 1 μ F, 100V, 10% 0805	MURATA, GRJ21BC72A105KE11L
7	1	C7	CAP, X7R, 2.2nF, 250V, 10% 0805	MURATA, GRM21AR72E222KW01D
8	1	C9	CAP, C0G, 680pF, 50V, 5% 0603	WURTH ELEKTRONIK, 885012006062
9	1	D1	DIODE, CMMR1U-02 SOD-123F	CENTRAL SEMI., CMMR1U-02
10	2	D2, D3	DIODE, BAV21W, SOD-123	MICRO COMMERCIAL CO., BAV21W-TP
11	1	D4	DIODE, BAT54A, SOT23	DIODES., BAT54A-7-F
12	1	D5	DIODE, HIGH-SPEED DIODE, SOD-523	NXP/PHILLIPS SEMI., BAS516
13	1	L1	INDUCTOR, 39 μ H,	CHAMPS, HRPQA2050-39
14	2	Q3, Q4	N-MOSFET, POWER 56	FAIRCHILD, FDMS86200DC
15	1	R1	RES., CHIP, 31.6k, 0.1W, 1% 0603	VISHAY, CRCW060331K6FKEA
16	1	R2	RES., CHIP, 100k, 0.1W, 1% 0603	VISHAY, CRCW0603100KFKEA
17	1	R6	RES., CHIP, 61.9k, 0.1W, 1% 0603	VISHAY, CRCW060361K9FKEA
18	1	R9	RES., CHIP, 200k, 0.125W, 1% 0805	VISHAY, CRCW0805200KFKEA
19	1	R14	RES., CHIP, 15 Ω , 0.1W, 1% 0603	VISHAY, CRCW060315R0FKEA
20	1	R3	RES., CHIP, 10k, 0.1W, 1% 0603	VISHAY, CRCW060310K0FKEA
21	2	R4, R10	RES., CHIP, 10 Ω , 0.1W, 1% 0603	VISHAY, CRCW060310R0FKEA
22	1	R11	RES., CHIP, 20k, 3/4W, 1% 2010	VISHAY, CRCW201020K0FKEF
23	2	R12, R13	RES., CHIP, 100 Ω , 0.1W, 1% 0603	VISHAY, CRCW0603100RFKEA
24	1	U1	I.C., LT3753EFE#TRPBF, TSSOP-38(31)	LINEAR TECH., LT3753EFE#TRPBF
DC2324A-A Required Circuit Components				
25	4	CIN1-CIN4	CAP, X7S, 4.7 μ F, 100V, 10% 1210	MURATA, GRJ32DC72A475KE11L
26	1	C6	CAP, X7R, 47nF, 250V, 10% 1206	MURATA, GRM31CR72E473KW03L
27	1	Q1	N-MOSFET POWER-56	FAIRCHILD, FDMS86200DC
28	1	Q2	P-MOSFET POWER-33	VISHAY, Si7117DN-T1-E3
29	1	RCS1	RES., CHIP, 0.011 Ω , 1W, 1%, WIDE 1206	SUSUMU, PRL1632-R011-F-T5
30	1	R5	RES., CHIP, 28k, 0.1W, 1% 0603	VISHAY, CRCW060328K0FKEA
31	1	R7	RES., CHIP, 3.48k, 0.1W, 1% 0603	VISHAY, CRCW06033K48FKEA
32	1	R8	RES., CHIP, 4.22k, 0.1W, 1% 0603	VISHAY, CRCW06034K22FKEA
33	1	T1	TRANSFORMER,	CHAMPS, G45R2-0808-S01-80R
DC2324A-B Required Circuit Components				
25	4	CIN1-CIN4	CAP, X7R, 10 μ F, 50V, 10% 1210	MURATA, GRM32ER71H106KA12L
26	1	C6	CAP, X7R, 150nF, 250V, 10% 1210	MURATA, GRM32QR72E154KW01L
27	1	Q1	N-MOSFET POWER-56	FAIRCHILD, FDMS86101DC
28	1	Q2	P-MOSFET SOT23	VISHAY, Si2337DS-T1-GE3
29	1	RCS1	RES., CHIP, 0.005 Ω , 1W, 1%, 0815	SUSUMU, RL3720WT-R005-F
30	1	R5	RES., CHIP, 40.2k, 0.1W, 1% 0603	VISHAY, CRCW060340K2FKEA

dc2324aabcf

DEMO MANUAL DC2324A-A, DC2324A-B, DC2324A-C

PARTS LIST

ITEM	QTY	REFERENCE	PART DESCRIPTION	MANUFACTURER/PART NUMBER
31	1	R7	RES., CHIP, 7.32k, 0.1W, 1% 0603	VISHAY, CRCW06037K32FKEA
32	1	R8	RES., CHIP, 8.66k, 0.1W, 1% 0603	VISHAY, CRCW06038K66FKEA
33	1	T1	TRANSFORMER,	CHAMPS, G45R2-0408-S01-25R

DC2324A-C Required Circuit Components

25	4	CIN1-CIN4	CAP, X7R, 22 μ F, 25V, 10% 1210	MURATA, GRM32ER71E226KE15L
26	1	C6	CAP, X7R, 330nF, 250V, 10% 1812	MURATA, GRM43DR72E334KW01L
27	1	Q1	N-MOSFET PG-TDSON	INFINEON, BSC010N04LSATMA1
28	1	Q2	P-MOSFET SC-70	VISHAY, SQ1421EEH-T1-GE3
29	1	RCS1	RES., CHIP, 0.003 Ω , 1W, 1%, 0815	SUSUMU, RL3720WT-R003-F
30	1	R5	RES., CHIP, 40.2k, 0.1W, 1% 0603	VISHAY, CRCW060340K2FKEA
31	1	R7	RES., CHIP, 16.2k, 0.1W, 1% 0603	VISHAY, CRCW060316K2FKEA
32	1	R8	RES., CHIP, 19.6k, 0.1W, 1% 0603	VISHAY, CRCW060319K6FKEA
33	1	T1	TRANSFORMER,	CHAMPS, G45R2-0208-S01-8R0

Additional Demo Board Circuit Components for All Versions

1	0	CO2(OPT)	CAP, 1210	
2	0	C8(OPT)	CAP, 100V, SIZE 12X10	

Hardware: For Demo Board Only (All Versions)

1	2	E1, E2	TESTPOINT, TURRET, 0.061" PBF	MILL-MAX, 2308-2-00-80-00-00-07-0
2	4	E3, E4, E5, E6	TESTPOINT, TURRET, 0.094" PBF	MILL-MAX, 2501-2-00-80-00-00-07-0
3	4	J1-J4	BANANA JACK	KEYSTONE, 575-4
4	4	MH1-MH4	STAND-OFF, NYLON 9.5mm	WURTH ELEKTRONIK, 702933000

DEMO MANUAL DC2324A-A, DC2324A-B, DC2324A-C

SCHEMATIC DIAGRAM

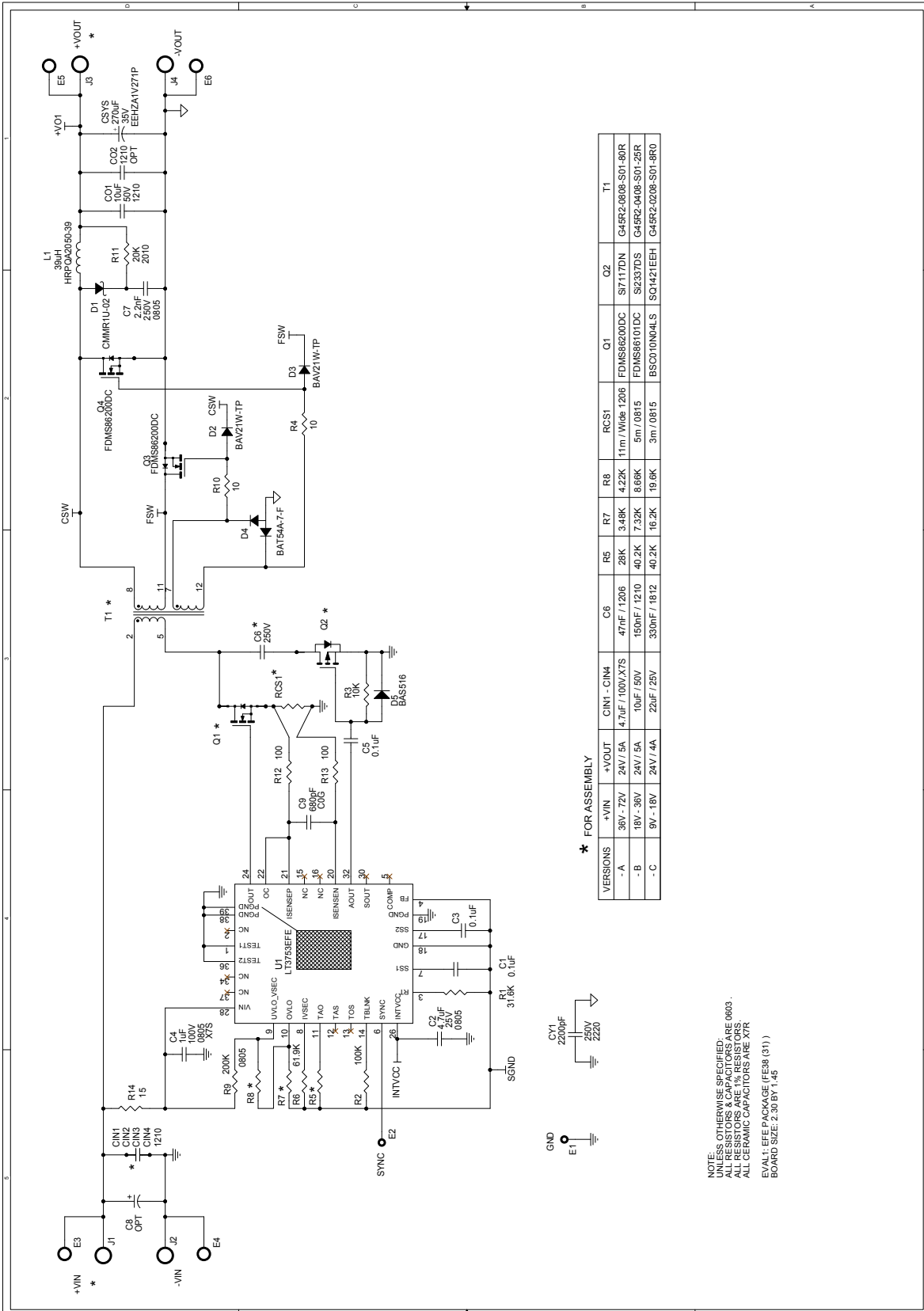

* FOR ASSEMBLY

VERSIONS	+VIN	+VOUT	CIN1 - CIN4	C6	R5	R7	R8	RCS1	Q1	Q2	T1
-A	36V / 72V	24V / 5A	4.70UF / 100V/X7S	47UF / 120V	28K	3.48K	4.22K	11m / 100e / 206	FDM58620DDC	S7171DN	G45R2-3806-S01-80R
-B	18V - 36V	24V / 5A	10UF / 50V	150mF / 1210	40.2K	7.32K	8.66K	5m / 0815	FDM58610TDC	S2237DS	G45R2-0406-S01-25R
-C	9V - 18V	24V / 4A	22UF / 25V	330mF / 1812	40.2K	16.2K	19.6K	3m / 0815	BSC010N04LS	SQ1421EEH	G45R2-0208-S01-8R0

NOTE:
UNLESS OTHERWISE SPECIFIED,
ALL RESISTORS & CAPACITORS ARE 0603.
ALL RESISTORS ARE 1% RESISTORS.
ALL CERAMIC CAPACITORS ARE X7R
EVAL1.EFE PACKAGE (FE38 (31))
BOARD SIZE: 2.30 BY 1.45

DEMO MANUAL DC2324A-A, DC2324A-B, DC2324A-C

DEMONSTRATION BOARD IMPORTANT NOTICE

Linear Technology Corporation (LTC) provides the enclosed product(s) under the following **AS IS** conditions:

This demonstration board (DEMO BOARD) kit being sold or provided by Linear Technology is intended for use for **ENGINEERING DEVELOPMENT OR EVALUATION PURPOSES ONLY** and is not provided by LTC for commercial use. As such, the DEMO BOARD herein may not be complete in terms of required design-, marketing-, and/or manufacturing-related protective considerations, including but not limited to product safety measures typically found in finished commercial goods. As a prototype, this product does not fall within the scope of the European Union directive on electromagnetic compatibility and therefore may or may not meet the technical requirements of the directive, or other regulations.

If this evaluation kit does not meet the specifications recited in the DEMO BOARD manual the kit may be returned within 30 days from the date of delivery for a full refund. **THE FOREGOING WARRANTY IS THE EXCLUSIVE WARRANTY MADE BY THE SELLER TO BUYER AND IS IN LIEU OF ALL OTHER WARRANTIES, EXPRESSED, IMPLIED, OR STATUTORY, INCLUDING ANY WARRANTY OF MERCHANTABILITY OR FITNESS FOR ANY PARTICULAR PURPOSE. EXCEPT TO THE EXTENT OF THIS INDEMNITY, NEITHER PARTY SHALL BE LIABLE TO THE OTHER FOR ANY INDIRECT, SPECIAL, INCIDENTAL, OR CONSEQUENTIAL DAMAGES.**

The user assumes all responsibility and liability for proper and safe handling of the goods. Further, the user releases LTC from all claims arising from the handling or use of the goods. Due to the open construction of the product, it is the user's responsibility to take any and all appropriate precautions with regard to electrostatic discharge. Also be aware that the products herein may not be regulatory compliant or agency certified (FCC, UL, CE, etc.).

No License is granted under any patent right or other intellectual property whatsoever. **LTC assumes no liability for applications assistance, customer product design, software performance, or infringement of patents or any other intellectual property rights of any kind.**

LTC currently services a variety of customers for products around the world, and therefore this transaction **is not exclusive**.

Please read the DEMO BOARD manual prior to handling the product. Persons handling this product must have electronics training and observe good laboratory practice standards. **Common sense is encouraged.**

This notice contains important safety information about temperatures and voltages. For further safety concerns, please contact a LTC application engineer.

Mailing Address:

Linear Technology
1630 McCarthy Blvd.
Milpitas, CA 95035

Copyright © 2004, Linear Technology Corporation