

## Three-Phase Sine-wave Sensor-Less Fan Motor Driver

### Features

- **PWM Quasi-Sinusoidal Driver**
- **Three-Phase Sensor-Less Drive Method**
- **Adjustable Forced Commutation Frequency (for Start-up)**
- **Built-In External PWM Speed Control**
- **Built-In Quick Start Function**
- **FG (Rotation Speed Detection) Output**
- **Soft Switching Circuit (for Noise Reducing)**
- **Power Saving Function (PWM Duty Input is 0%)**
- **Built-In Lock Protection and Auto Restart Function**
- **Thermal Shutdown Circuit**
- **Lead Free and Green Devices Available (RoHS Compliant)**

### General Description

The APX9358E provides all the circuitry for sensor-less speed control of three-phase brushless DC motor. The Sine-wave Driver Method will be better low-noise. The controller functions include start-up circuit, back-EMF commutation control, Pulse Width Modulation (PWM) speed control, lock protection, and thermal shutdown circuit.

The APX9358E is suitable for both game machine and CPU cooler that need silent drivers. It is available in VTDFN3x3-10 package.

### Applications

- **Motor Driver For Silent Fan Motors**

### Pin Configuration

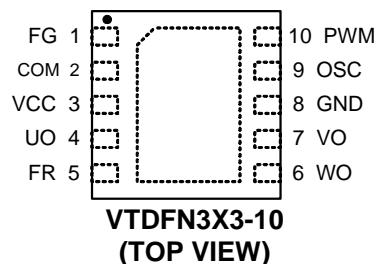

 = Thermal Pad (connected to the GND plane for better heat dissipation)

ANPEC reserves the right to make changes to improve reliability or manufacturability without notice, and advise customers to obtain the latest version of relevant information to verify before placing orders.

## Ordering and Marking Information

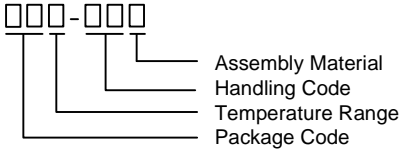
<p>APX9358E □□□-□□□</p>  <p>Assembly Material Handling Code Temperature Range Package Code</p>	<p>Package Code QF : VTDFN3X3-10 Operating Ambient Temperature Range I : -40 to 105 °C Handling Code TR : Tape &amp; Reel Assembly Material G : Halogen and Lead Free Device</p>	
<p>APX9358E QF : <table border="1" style="display: inline-table; vertical-align: middle;"> <tr> <td style="padding: 2px;">                     APX 9358E •XXXXX                 </td> </tr> </table></p>	APX 9358E •XXXXX	<p>XXXXX - Date Code</p>
APX 9358E •XXXXX		

Note: ANPEC lead-free products contain molding compounds/die attach materials and 100% matte tin plate termination finish; which are fully compliant with RoHS. ANPEC lead-free products meet or exceed the lead-free requirements of IPC/JEDEC J-STD-020D for MSL classification at lead-free peak reflow temperature. ANPEC defines "Green" to mean lead-free (RoHS compliant) and halogen free (Br or Cl does not exceed 900ppm by weight in homogeneous material and total of Br and Cl does not exceed 1500ppm by weight).

## Absolute Maximum Ratings (Note 1)

Symbol	Parameter	Rating	Unit
$V_{CC}$	VCC Pin Supply Voltage	-0.3 to 7	V
$I_{OUT}$	UO/VO/WO Pin Output Current	0 to 1	A
$V_{UO}/V_{VO}/V_{WO}$	UO/VO/WO Pin Output Voltage	-0.3 to 7	V
$V_{FG}$	FG Pin Output Voltage	-0.3 to 7	V
$I_{FG}$	FG Pin Sink Current	0 to 10	mA
$V_{FR}$	FR Pin Input Voltage	-0.3 to 7	V
$T_J$	Junction Temperature	-40 to 150	°C
$T_{STG}$	Storage Temperature	-65 to 150	°C
$T_{SDR}$	Maximum Lead Soldering Temperature, 10 Seconds	260	°C

Note1: Stresses beyond those listed under "absolute maximum ratings" may cause permanent damage to the device. These are stress ratings only and functional operation of the device at these or any other conditions beyond those indicated under "recommended operating conditions" is not implied. Exposure to absolute maximum rating conditions for extended periods may affect device reliability.

## Thermal Characteristics

Symbol	Parameter	Typical Value	Unit
$\theta_{JA}$	Thermal Resistance-Junction to Ambient <sup>(Note2)</sup> VTDFN3x3-10	119	°C/W
$P_D$	Power Dissipation, $T_A=25^\circ\text{C}$ VTDFN3x3-10	1.05	W

Note 2:  $\theta_{JA}$  is measured with the component mounted on a 55mm x 40mm x 1.6mm glass epoxy board (two-layer) in free air.

## Recommended Operating Conditions

Symbol	Parameter	Range	Unit
$V_{CC}$	VCC Pin Supply Voltage Range	1.8 to 6	V
$V_{PWM}$	PWM Pin Input Voltage Range	0 to $V_{CC}$	V
$T_A$	Ambient Temperature	-40 to 105	°C
$I_{OUT}$	UO/VO/WO Pin Average Output Current	0 to 400	mA

## Electrical Characteristics ( $V_{CC}=5V$ , $T_A=25^{\circ}C$ , unless otherwise specified)

Symbol	Parameter	Test Conditions	APX9358E			Unit
			Min.	Typ.	Max.	
<b>SUPPLY CURRENT</b>						
$I_{CC1}$	Operating Current	Rotation Mode, $FR=V_{CC}$	-	4.5	6	mA
$I_{CC2}$	Standby Supply Current	PWM=0	-	130	180	$\mu A$
<b>PWM CONTROL</b>						
$V_{PWMH}$	PWM Input High Level Voltage		2.5	-	$V_{CC}+0.3$	V
$V_{PWML}$	PWM Input Low Level Voltage		-0.3	-	0.8	V
$I_{PWMH}$	PWM High Input Current	PWM= $V_{CC}$	-	0	-	$\mu A$
$I_{PWML}$	PWM Low Input Current	PWM=GND	-	25	30	$\mu A$
$F_{PWM}$	PWM Input Frequency		2	-	50	kHz
<b>Oscillator</b>						
$V_{OSCH}$	OSC Pin High Level Voltage		1	1.2	1.4	V
$V_{OSCL}$	OSC Pin Low Level Voltage		0.5	0.6	0.7	V
$I_{OSC1}$	OSC Pin Charge Current	$V_{OSC}=0V$	-	16.5	-	$\mu A$
$I_{OSC2}$	OSC Pin Discharge Current	$V_{OSC}=1.2V$	-	16.5	-	$\mu A$
<b>OUTPUT DRIVERS</b>						
$V_O$	Output Driver Saturation Voltage	$I_{OUT}=250mA$ , Upper and Lower total	-	0.3	0.44	V
$V_{FG}$	FG Pin Low Voltage	$I_{FG}=5mA$	-	0.2	0.3	V
$I_{FGL}$	FG Pin Leak Current	$V_{FG}=7V$	-	-	10	$\mu A$
$V_{FRH}$	FR Input High Threshold Voltage		$0.5 \times V_{CC}$	-	$V_{CC}$	V
$V_{FRL}$	FR Input Low Threshold Voltage		0	-	$0.1 \times V_{CC}$	V
<b>LOCK PROTECTION</b>						
$T_{ON}$	Lock Detection On Time		0.85	1	1.15	sec
$T_{OFF}$	Lock Detection Off Time		4.25	5	5.75	sec
<b>THERMAL SHUTDOWN</b>						
OTS	Over Temperature Shutdown		-	160	-	$^{\circ}C$
	Over Temperature Shutdown Hysteresis		-	30	-	
<b>QUICK START</b>						
$T_{QS}$	Quick Start Enable Time		-	16	-	ms

### Typical Operating Characteristics

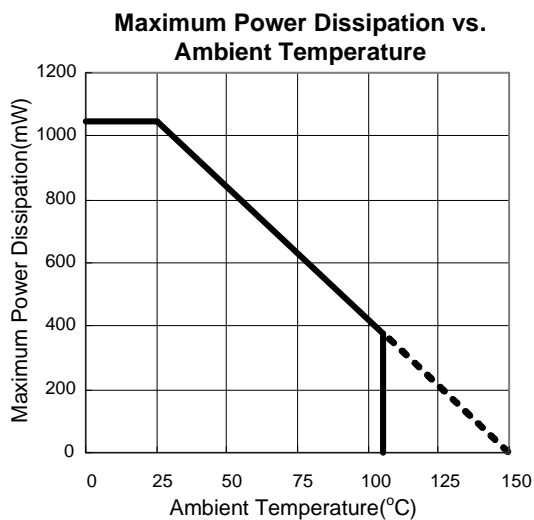
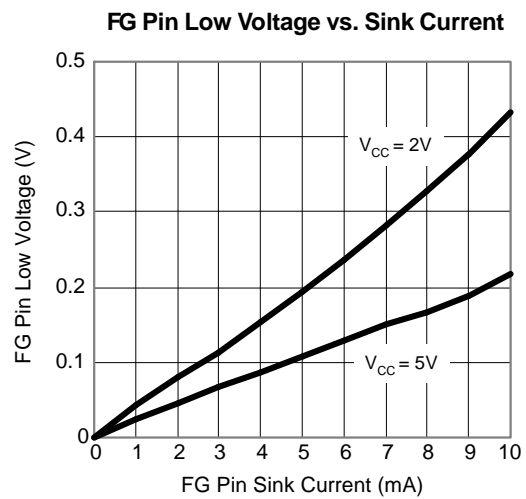
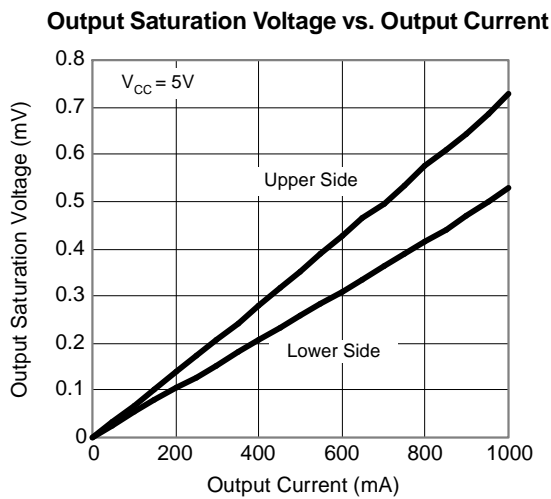
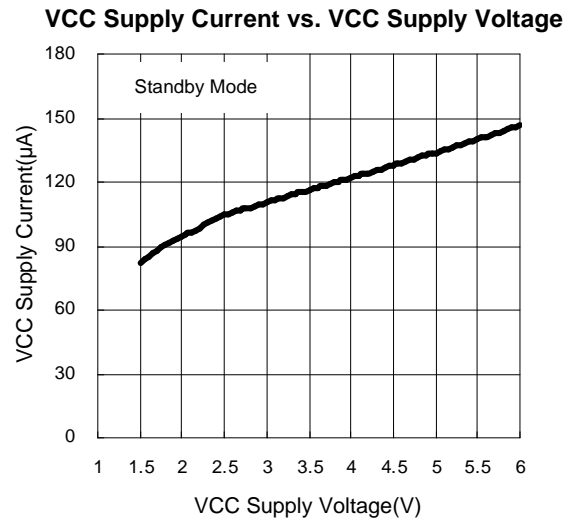
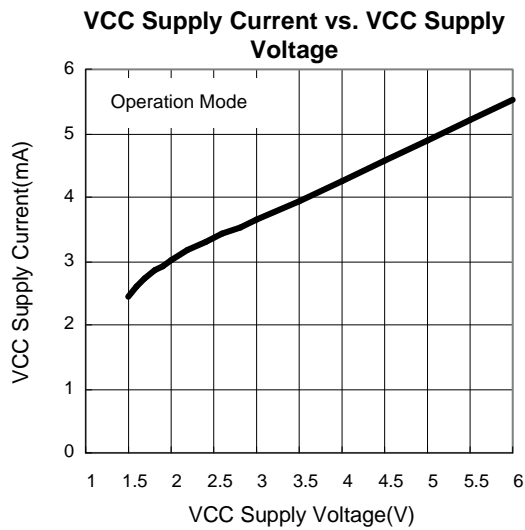

Operating Waveforms

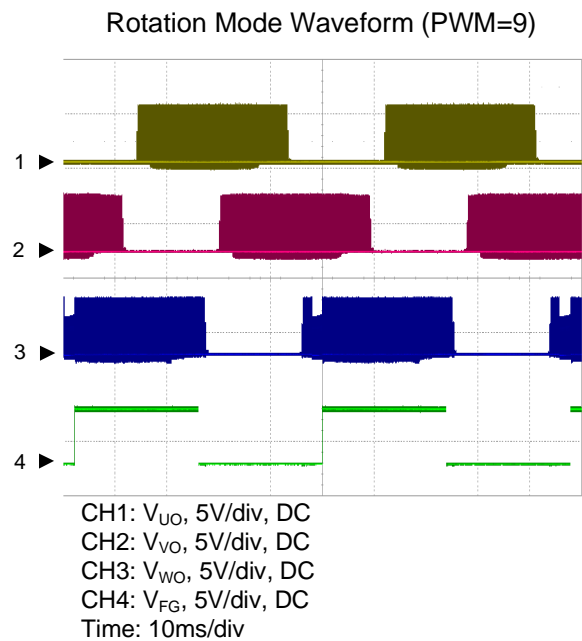
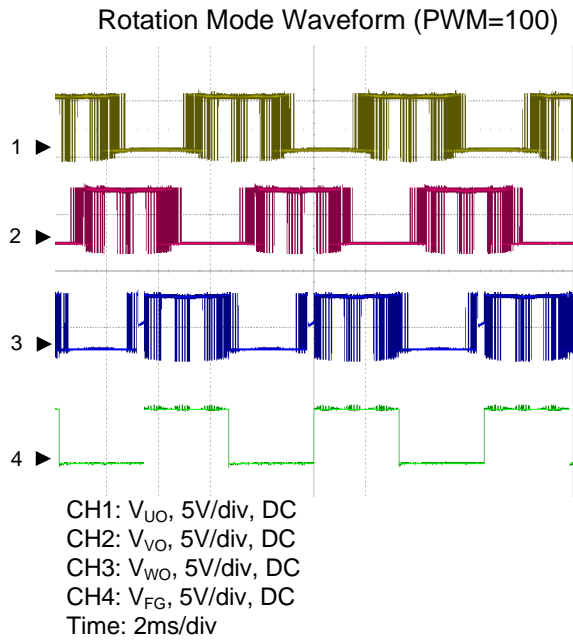

### Pin Description

PIN		Description
No.	Name	
1	FG	Rotation Speed Output. This is an open-drain output.
2	COM	Motor Neutral Point Input Pin
3	VCC	Supply Voltage Input Pin.
4	UO	Driver Output Pin. Output signal for driving motor phase U.
5	FR	Motor Spin Direction Control Pin. High Level Input: U → V → W (Floating) Low Level Input: U → W → V
6	WO	Driver Output Pin. Output signal for driving motor phase W.
7	VO	Driver Output Pin. Output signal for driving motor phase V.
8	GND	Ground Pin.
9	OSC	Start-up Commutation Time Setting. Connect a capacitor to GND to set start-up commutation time.
10	PWM	PWM Signal Input Pin. Input PWM signal to control rotation speed.

### Block Diagram

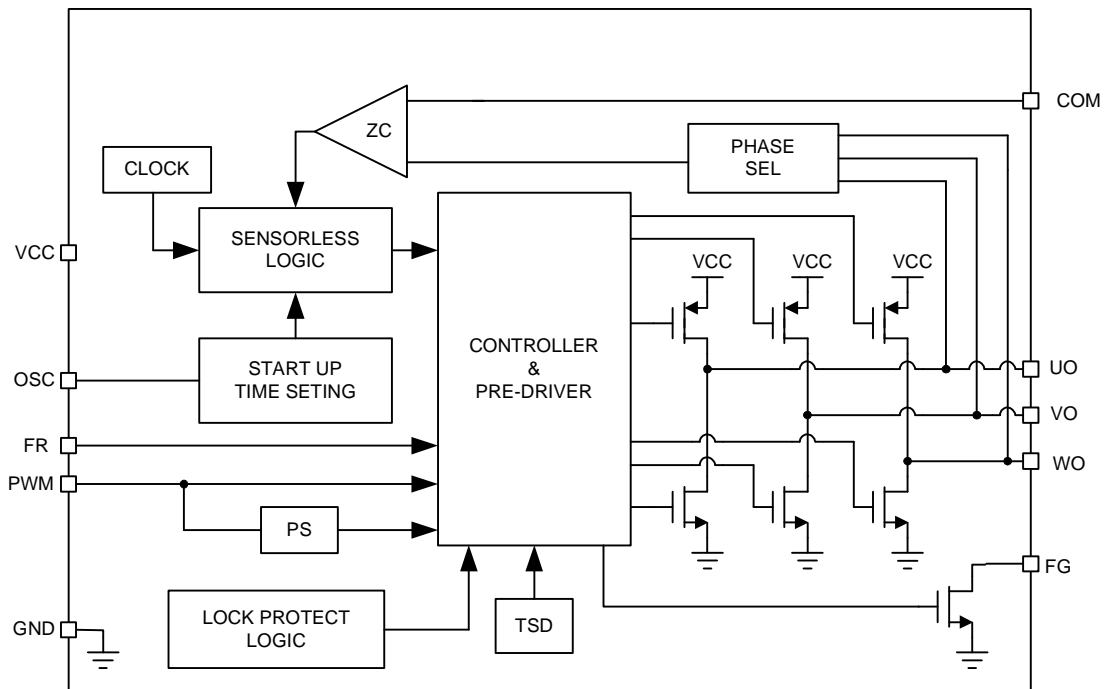

Typical Application Circuit

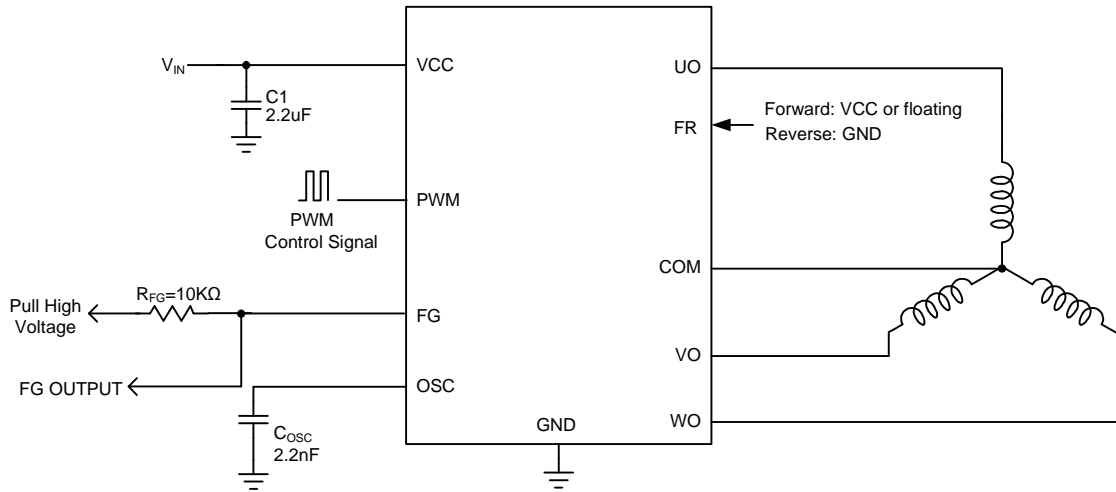



## Function Description

### PWM Speed Control (fixed-frequency output)

It is possible to change rotation speed of the motor by switching output transistor. The on-duty of switching depends on the signal from input to PWM terminal. The output PWM frequency is fixed to 30KHz typically.

(See Figure 1 PWM Input Waveform)

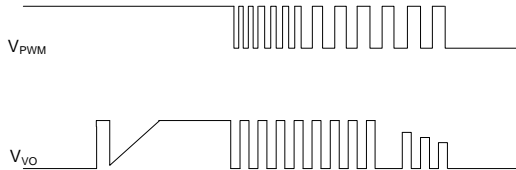

Figure 1. PWM Input Waveform

### Quick Start

This IC disables the lock protection function when the PWM input keeps low level for more than 16ms. (See Figure 2 Quick Start Waveform)

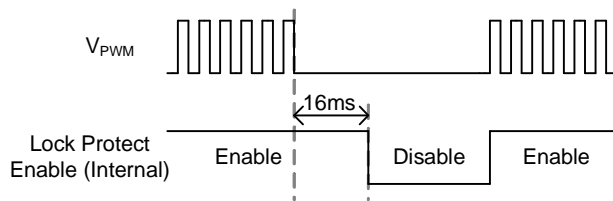

Figure 2. Quick Start Waveform

### FG Output

The FG pin is an open-drain output, connecting a pull up resistor to a high level voltage for the speed detection function. When WO pin voltage switches to high, the FG is high (switch off) and the WO pin voltage switches to low then FG is low (switch on). The FG output only works in sensor-less mode. (See Figure 3 FG Output Waveform)

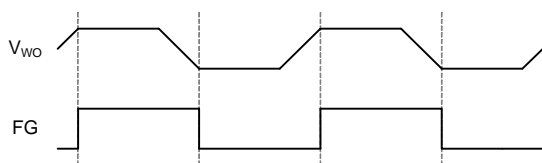

Figure 3. FG Output Waveform

### Soft Switch (sine-wave output)

The is a soft switch function to make phase current become smooth, which can reduce the noise of motor in switching interval. Using PWM duty cycle control to create the sinusoidal current waveform. BEMF detection window is opened on phase W in order to measure the rotor position so as to define the modulation timing. close to the ideal sine wave output. ( See figure 4. Sinusoidal PWM)

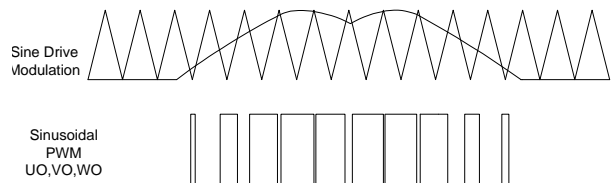

Figure 4. Sinusoidal PWM

### Lock Protection and Automatic Restart

The APX9358E provides the lock protection and automatic restart functions to prevent the coil burnout while the fan is locked. As the fan is locked, the IC will come into start-up operation for 1 second. Then, the IC will switch to lock protection mode to turn off output driver for 5 seconds. After lock protection mode, the IC switches to start-up operation again. If the locked condition still remains, the lock-and-restart process will be recurred until the locked condition is released.

### Thermal Protection

The APX9358E has thermal protection. When internal junction temperature reaches 160°C, the output devices will be switched off. When the IC's junction temperature cools down 30°C, the thermal sensor will turn on the output devices again, resulting in a pulsed output during continuous thermal protection.

## Application Information

### Input Protection Capacitor

For the noise reduction purpose, a capacitor (C1) is connected between VCC and GND. (see Typical Application Circuit) It's suggested that C1 should be placed as close as possible in the VCC pin.

### OSC Capacitor

The capacitor connects from OSC pin to GND can be determined the frequency of force commutation. The optimal design of the frequency could make sure the motor start-up in succeed. Its capacitance from 1000pF to 3300pF is recommended.

$$T_{OSC} = \frac{2 \times (V_{OSCH} - V_{OSCL}) \times C_{OSC}}{I_{OSC}} \times 16 \times 50$$

For example:

$$C_{OSC} = 2.2nF$$

$$V_{OSCL} = 0.6V$$

$$V_{OSCH} = 1.2V$$

$$I_{OSC} = (I_{OSC1} + I_{OSC2}) / 2 = 16.5\mu A$$

The force start up time is 128ms

External capacitor	Synchronized time
3300pF	192mS
2200pF	128mS
1000pF	58.18mS

Table 1. Capacitor values and synchronized time

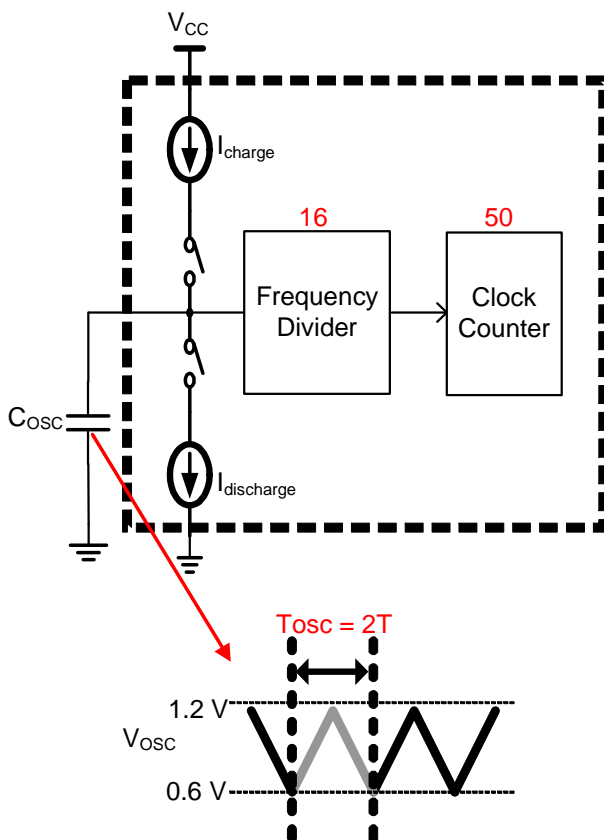

Figure 5. OSC Circuit

## Application Information (Cont.)

### FG Resistor

The value of FG resistor could be decided by the following equation:

$$R_{FG} = \frac{V_{CC} - V_{FG/RD}}{I_{FG/RD}}$$

For example:

$$V_{CC} = 5V, I_{FG} = 5mA, V_{FG} = 0.2V, R_{FG} = 0.96k\Omega$$

The value of resistor in the range of 1kΩ to 10kΩ is recommended.

### Thermal Consideration

Refer to “Maximum Power Dissipation vs. Ambient Temperature”, the IC is safe to operate below the curve and it will cause the thermal protection if the operating area is above the line. For example,  $T_A = 75^\circ C$ , the VTDFN3x3-10 package maximum power dissipation is about 0.63W. The power dissipation can be calculated by the following equation:

$$P_D = (V_{CC} - |V_{UO} - V_{VO}|) \times I_{UO} + V_{CC} \times I_{CC}$$

For example:

$$V_{CC} = 5V, I_{CC} = 3mA, I_{OUT} = 250mA, V_{UO} = 4.85V,$$

$$V_{VO} = 0.15V, \text{ then } P_D = 0.09W$$

The GND pin provides an electrical connection to the ground and channeling heat away. The printed circuit board (PCB) forms a heat sink and dissipates most of the heat into ambient air.

Package Information

VTDFN3x3-10

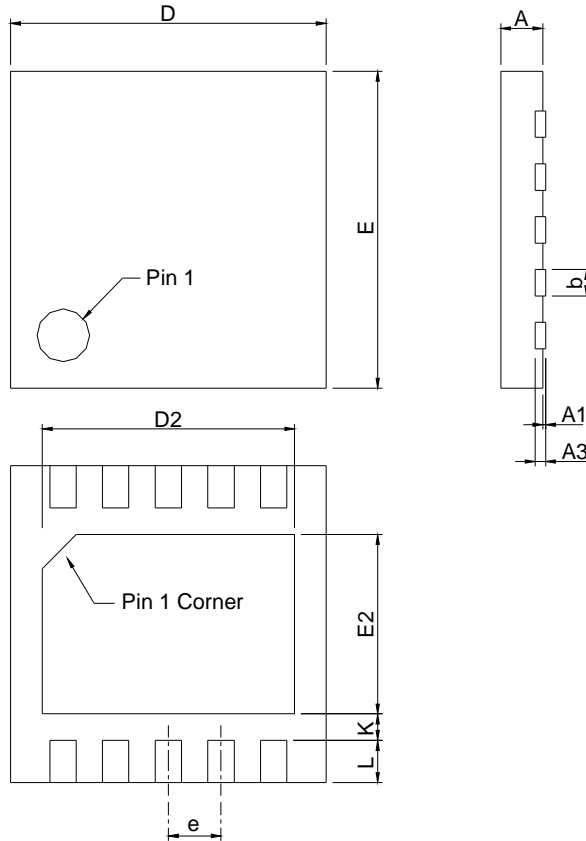

SYMBOL	VTDFN3*3-10			
	MILLIMETERS		INCHES	
	MIN.	MAX.	MIN.	MAX.
A	0.50	0.60	0.020	0.024
A1	0.00	0.05	0.000	0.002
A3	0.152 REF		0.006 REF	
b	0.18	0.30	0.007	0.012
D	2.90	3.10	0.114	0.122
D2	2.20	2.70	0.087	0.106
E	2.90	3.10	0.114	0.122
E2	1.40	1.75	0.055	0.069
e	0.50 BSC		0.020 BSC	
L	0.30	0.50	0.012	0.020
K	0.20		0.008	

### Carrier Tape & Reel Dimensions

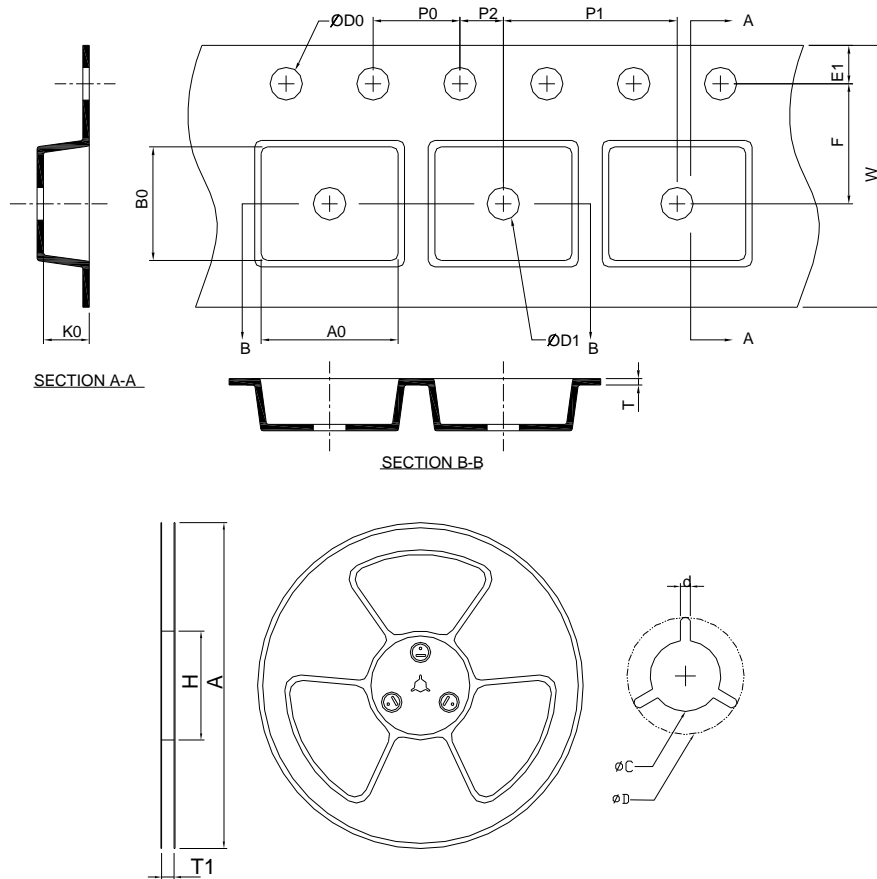

Application	A	H	T1	C	d	D	W	E1	F
VTDFN3x3-10	330.0±2.00	50 MIN.	12.4+2.00 -0.00	13.0+0.50 -0.20	1.5 MIN.	20.2 MIN.	12.0±0.30	1.75±0.10	5.5±0.05
	P0	P1	P2	D0	D1	T	A0	B0	K0
	4.0±0.10	8.0±0.10	2.0±0.05	1.5+0.10 -0.00	1.5 MIN.	0.6+0.00 -0.40	3.30±0.20	3.30±0.20	0.75±0.20

(mm)

### Devices Per Unit

Package Type	Unit	Quantity
VTDFN3x3-10	Tape & Reel	3000

### Taping Direction Information

VTDFN3x3-10

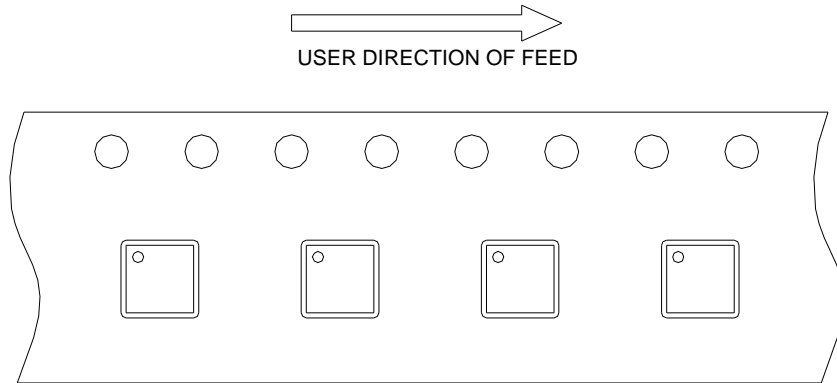

### Classification Profile

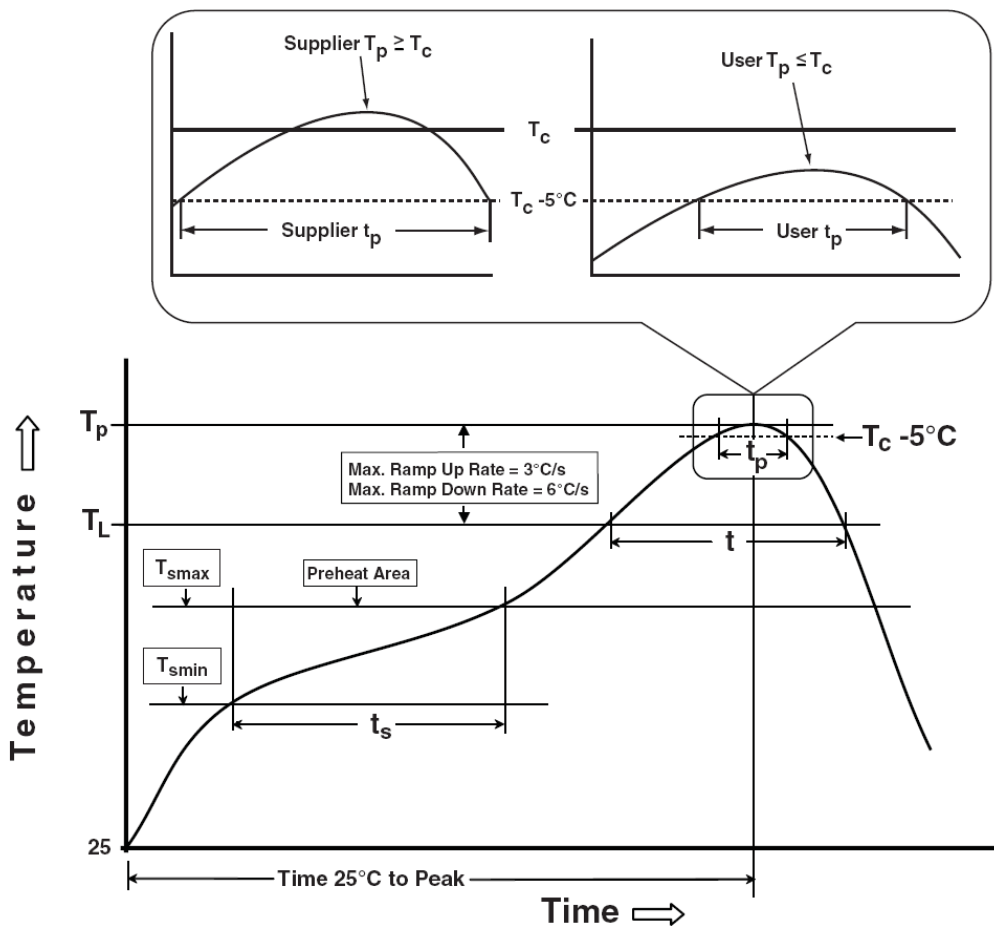

### Classification Reflow Profiles

Profile Feature	Sn-Pb Eutectic Assembly	Pb-Free Assembly
<b>Preheat &amp; Soak</b> Temperature min ( $T_{smin}$ ) Temperature max ( $T_{smax}$ ) Time ( $T_{smin}$ to $T_{smax}$ ) ( $t_s$ )	100 °C 150 °C 60-120 seconds	150 °C 200 °C 60-120 seconds
Average ramp-up rate ( $T_{smax}$ to $T_p$ )	3 °C/second max.	3°C/second max.
Liquidous temperature ( $T_L$ ) Time at liquidous ( $t_L$ )	183 °C 60-150 seconds	217 °C 60-150 seconds
Peak package body Temperature ( $T_p$ )*	See Classification Temp in table 1	See Classification Temp in table 2
Time ( $t_p$ )** within 5°C of the specified classification temperature ( $T_c$ )	20** seconds	30** seconds
Average ramp-down rate ( $T_p$ to $T_{smax}$ )	6 °C/second max.	6 °C/second max.
Time 25°C to peak temperature	6 minutes max.	8 minutes max.
* Tolerance for peak profile Temperature ( $T_p$ ) is defined as a supplier minimum and a user maximum. ** Tolerance for time at peak profile temperature ( $t_p$ ) is defined as a supplier minimum and a user maximum.		

Table 1. SnPb Eutectic Process – Classification Temperatures ( $T_c$ )

Package Thickness	Volume mm <sup>3</sup> <350	Volume mm <sup>3</sup> ≥350
<2.5 mm	235 °C	220 °C
≥2.5 mm	220 °C	220 °C

Table 2. Pb-free Process – Classification Temperatures ( $T_c$ )

Package Thickness	Volume mm <sup>3</sup> <350	Volume mm <sup>3</sup> 350-2000	Volume mm <sup>3</sup> >2000
<1.6 mm	260 °C	260 °C	260 °C
1.6 mm – 2.5 mm	260 °C	250 °C	245 °C
≥2.5 mm	250 °C	245 °C	245 °C

### Reliability Test Program

Test item	Method	Description
SOLDERABILITY	JESD-22, B102	5 Sec, 245°C
HOLT	JESD-22, A108	1000 Hrs, Bias @ $T_j=125^\circ\text{C}$
PCT	JESD-22, A102	168 Hrs, 100%RH, 2atm, 121°C
TCT	JESD-22, A104	500 Cycles, -65°C~150°C
HBM	MIL-STD-883-3015.7	VHBM ≥ 2KV
MM	JESD-22, A115	VMM ≥ 200V
Latch-Up	JESD 78	10ms, $1_{tr} \geq 100\text{mA}$

## Customer Service

**Anpec Electronics Corp.**

Head Office :

No.6, Dusing 1st Road, SBIP,  
Hsin-Chu, Taiwan  
Tel : 886-3-5642000  
Fax : 886-3-5642050

Taipei Branch :

2F, No. 11, Lane 218, Sec 2 Jhongsing Rd.,  
Sindian City, Taipei County 23146, Taiwan  
Tel : 886-2-2910-3838  
Fax : 886-2-2917-3838