



# KTX-WB9224225AZZZ

KTX Prime

CONTRAST SENSORS

**SICK**  
Sensor Intelligence.



### Ordering information

Type	Part no.
KTX-WB9224225AZZZZ	1078084

Other models and accessories → [www.sick.com/KTX\\_Prime](http://www.sick.com/KTX_Prime)



### Detailed technical data

#### Features

<b>Dimensions (W x H x D)</b>	30 mm x 53 mm x 78.5 mm
<b>Sensing distance</b>	25 mm
<b>Sensing distance tolerance</b>	± 6 mm
<b>Housing design (light emission)</b>	Rectangular
<b>Light source</b>	LED, RGB <sup>1)</sup>
<b>Wave length</b>	470 nm, 525 nm, 625 nm
<b>Light emission</b>	Short device side
<b>Light spot size</b>	5.3 mm x 1.2 mm
<b>Light spot direction</b>	Horizontal <sup>2)</sup>
<b>Teach-in mode</b>	1-point teach-in, 2-point teach-in, dynamic Teach-in, auto mode
<b>Output function</b>	Light/dark switching
<b>Delay time</b>	Adjustable
<b>Delivery status</b>	2-point teach-in
<b>Parameter presets</b>	None

<sup>1)</sup> Average service life: 100,000 h at T<sub>U</sub> = +25 °C.

<sup>2)</sup> In relation to long side of housing.

## Mechanics/electronics

<b>Supply voltage</b>	10.8 V DC ... 28.8 V DC <sup>1)</sup>
<b>Ripple</b>	$\leq 5 V_{pp}$ <sup>2)</sup>
<b>Power consumption</b>	< 100 mA <sup>3)</sup>
<b>Switching frequency</b>	50 kHz <sup>4)</sup>
<b>Response time</b>	10 $\mu$ s <sup>5)</sup>
<b>Jitter</b>	5 $\mu$ s
<b>Switching output</b>	PUSH/PULL
<b>Switching output (voltage)</b>	Push/Pull: HIGH = $V_S - 3 V$ / LOW $\leq 3 V$
<b>Output current <math>I_{max}</math></b>	100 mA <sup>6)</sup>
<b>Input, blanking input (AT)</b>	Blanked: U = 10 V ... < U <sub>v</sub> : free-running: U < 2 V
<b>Input, fine/coarse (F/C)</b>	Coarse: U = 10 V ... < U <sub>v</sub> : fine: U < 2 V
<b>Input, light/dark (L/D)</b>	Light: U = 10 V ... < U <sub>v</sub> : light: U < 2 V
<b>Retention time (ET)</b>	25 ms, non-volatile memory
<b>Connection type</b>	Male connector M12, 5-pin
<b>Protection class</b>	III
<b>Circuit protection</b>	U <sub>v</sub> connections, reverse polarity protected Output Q short-circuit protected Interference pulse suppression
<b>Enclosure rating</b>	IP67
<b>Weight</b>	94 g
<b>Housing material</b>	VISTAL®

<sup>1)</sup> Limit values: DC 12 V (-10 %) ... DC 24 V (+20 %). Operation in short-circuit protected network max. 8 A.

<sup>2)</sup> May not exceed or fall below U<sub>v</sub> tolerances.

<sup>3)</sup> Without load.

<sup>4)</sup> With light/dark ratio 1:1.

<sup>5)</sup> Signal transit time with resistive load.

<sup>6)</sup> Total current of all Outputs.

## Ambient data

<b>Ambient operating temperature</b>	-20 °C ... +60 °C
<b>Ambient storage temperature</b>	-25 °C ... +75 °C
<b>Shock load</b>	According to IEC 60068-2-27 (30 g/11 ms)
<b>UL File No.</b>	E181493

## Classifications

<b>ECl@ss 5.0</b>	27270906
<b>ECl@ss 5.1.4</b>	27270906
<b>ECl@ss 6.0</b>	27270906
<b>ECl@ss 6.2</b>	27270906
<b>ECl@ss 7.0</b>	27270906
<b>ECl@ss 8.0</b>	27270906
<b>ECl@ss 8.1</b>	27270906
<b>ECl@ss 9.0</b>	27270906

<b>ETIM 5.0</b>	EC001820
<b>ETIM 6.0</b>	EC001820
<b>UNSPSC 16.0901</b>	39121528

### Communication interface

<b>Communication interface</b>	IO-Link V1.1
<b>Communication Interface detail</b>	COM2 (38,4 kBaud)
<b>Cycle time</b>	2.3 ms
<b>Process data length</b>	16 Bit
<b>Process data structure</b>	Bit 0 = switching signal Q <sub>L1</sub> Bit 1 = empty Bit 2 = Quality of Run Alarm Bit 3 ... 5 = Emission Color Bit 6 ... 15 = Measurement Value Emission Color

Dimensional drawing (Dimensions in mm (inch))

KTX Prime

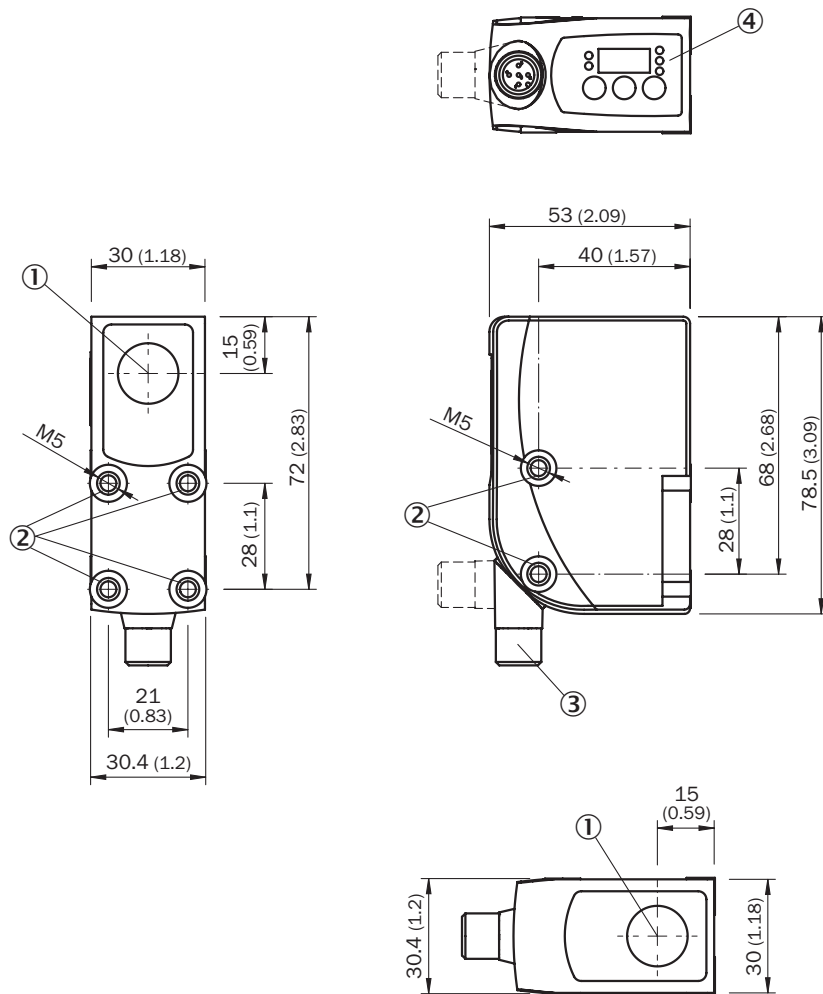

- ① Optical axis and light emission edge / length housing side
- ② Threaded mounting hole M5
- ③ Connector M12 (rotatable up to 180°)
- ④ Control panel

### Adjustments

KTS/KTX Prime

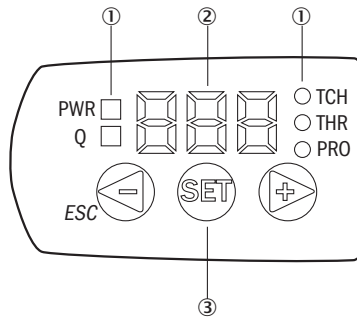

- ① LED status indicator
- ② Display
- ③ Control panel

### Connection diagram

cd-387

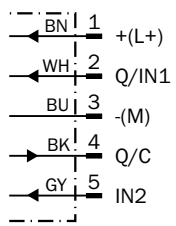

## Concept of operation

### KTS/KTX Prime - Setting the switching threshold (dynamic Teach-in)

Suitable for teaching in moving objects.

#### 1. Position background

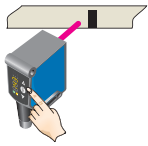

Press the Set pushbutton to start the teach-in process.

#### 2. Move at least the mark and background using the light spot

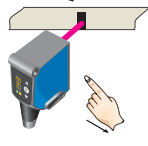

The display lights up during repeat length detection (---).

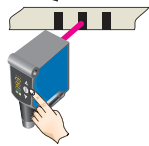

Press the Set pushbutton to end the teach-in process. The Quality of Teach is displayed.

#### Example

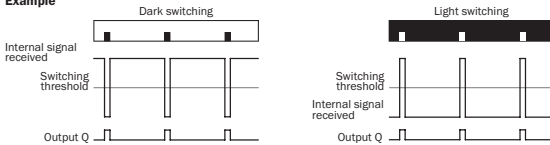

#### Switching characteristics

The optimum emitted light is selected automatically (at RGB variants).

Static teach-in: light/dark setting is defined using teach-in sequence.

Dynamic teach-in: switching output active on mark, if background is longer in the field of view during the teach-in.

The switching threshold is set in the center between the background and the mark.

Keylock (activation and deactivation): Press and hold the "+" pushbutton > 10 s.

The Q-LED (yellow) flashes and the "Err" error message appears on the display.

### KTS/KTX Prime - setting the switching threshold (2-point teach-in)

Suitable for manual positioning of the object to be detected, e.g. marks and background.

#### 1. Position mark

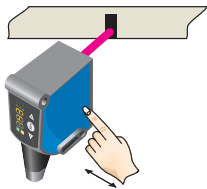

When setting the contrasts to be detected, "1st" flashes. Press set button.

#### 2. Position background

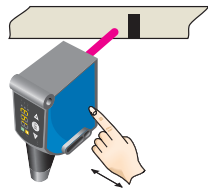

When setting the contrasts to be detected, "2nd" flashes. Press set button. The Quality of Teach is displayed.

### KTS/KTX Prime - Setting the switching threshold (color mode)

Suitable for teaching in color properties.

#### 1. Position mark/color property

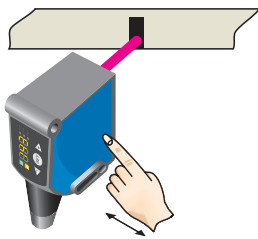

When detecting the contrast or color to be detected, "1st" flashes. Press set button. The Quality of Teach-in is displayed.



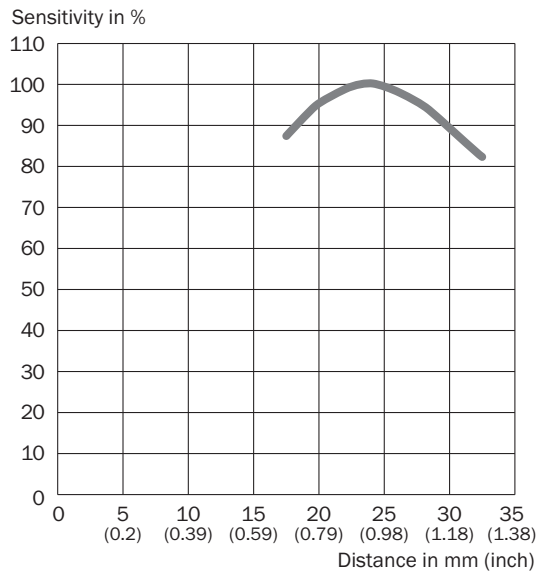

### Characteristic curve

Sensing distance 25 mm, light spot direction horizontal/vertical



### Recommended accessories

Other models and accessories → [www.sick.com/KTX\\_Prime](http://www.sick.com/KTX_Prime)

	Brief description	Type	Part no.
<b>Universal bar clamp systems</b>			
	Plate G for universal clamp bracket, steel, zinc coated, Universal clamp (2022726), mounting hardware	BEF-KHS-G01	2022464
	Plate K for universal clamp bracket, steel, zinc coated, Universal clamp (2022726), mounting hardware	BEF-KHS-K01	2022718
	Universal clamp bracket for rod mounting, steel, zinc coated, without mounting hardware	BEF-KHS-KH1	2022726
	Mounting bar, straight, 200 mm, steel, steel, zinc coated, without mounting hardware	BEF-MS12G-A	4056054
	Mounting bar, straight, 300 mm, steel, steel, zinc coated, without mounting hardware	BEF-MS12G-B	4056055
	Mounting bar, L-shaped, 150 mm x 150 mm, steel, steel, zinc coated, without mounting hardware	BEF-MS12L-A	4056052
	Mounting bar, L-shaped, 250 x 250 mm, steel, steel, zinc coated, without mounting hardware	BEF-MS12L-B	4056053



## SICK AT A GLANCE

SICK is one of the leading manufacturers of intelligent sensors and sensor solutions for industrial applications. A unique range of products and services creates the perfect basis for controlling processes securely and efficiently, protecting individuals from accidents and preventing damage to the environment.

We have extensive experience in a wide range of industries and understand their processes and requirements. With intelligent sensors, we can deliver exactly what our customers need. In application centers in Europe, Asia and North America, system solutions are tested and optimized in accordance with customer specifications. All this makes us a reliable supplier and development partner.

Comprehensive services complete our offering: SICK LifeTime Services provide support throughout the machine life cycle and ensure safety and productivity.

For us, that is “Sensor Intelligence.”

## WORLDWIDE PRESENCE:

Contacts and other locations –[www.sick.com](http://www.sick.com)