



# LMS102-10000

LMS1xx

2D LASER SCANNERS

**SICK**  
Sensor Intelligence.



### Ordering information

Type	Part no.
LMS102-10000	1048235

Other models and accessories → [www.sick.com/LMS1xx](http://www.sick.com/LMS1xx)



### Detailed technical data

#### Features

<b>Field of application</b>	Indoor
<b>Light source</b>	Infrared (905 nm)
<b>Laser class</b>	1 (IEC 60825-1 (2007-3))
<b>Aperture angle</b>	270°
<b>Scanning frequency</b>	25 Hz / 50 Hz
<b>Angular resolution</b>	0.25° 0.5°
<b>Heating</b>	No
<b>Operating range</b>	0.5 m ... 20 m
<b>Max. range with 10 % reflectivity</b>	18 m
<b>Amount of evaluated echoes</b>	2
<b>Fog correction</b>	Yes

#### Performance

<b>Response time</b>	≥ 20 ms
<b>Detectable object shape</b>	Almost any
<b>Systematic error</b>	± 30 mm <sup>1)</sup>
<b>Statistical error</b>	12 mm <sup>1)</sup>
<b>Integrated application</b>	Field evaluation with flexible fields
<b>Number of field sets</b>	10 fields
<b>Simultaneous evaluation cases</b>	10

<sup>1)</sup> Typical value; actual value depends on environmental conditions.

#### Interfaces

<b>Serial (RS-232)</b>	✓
Function	Host, AUX
Data transmission rate	9.6 kBaud ... 115.2 kBaud

<b>Ethernet</b>	✓
Function	Host
Data transmission rate	10/100 MBit/s
Protocol	TCP/IP, OPC
<b>CAN bus</b>	✓
Function	Extension of outputs
<b>Switching inputs</b>	2 digital and 2 encoder inputs
<b>Switching outputs</b>	3
<b>Optical indicators</b>	7-segment display (plus 5 LEDs showing device status, contamination warning and initial condition)

#### Mechanics/electronics

<b>Electrical connection</b>	1 x system plug with screw terminal block
<b>Operating voltage</b>	10.8 V DC ... 30 V DC
<b>Power consumption</b>	Typ. 8 W
<b>Housing color</b>	Black (RAL 9005)
<b>Enclosure rating</b>	IP 65 (EN 60529, Section 14.2.5)
<b>Protection class</b>	III (EN 50178 (1997;10))
<b>Weight</b>	1.1 kg
<b>Dimensions (L x W x H)</b>	105 mm x 102 mm x 152 mm

#### Ambient data

<b>Object remission</b>	2 % ... > 1,000 % (reflectors)
<b>Electromagnetic compatibility (EMC)</b>	EN 61000-6-2:2005 / EN 61000-6-4 (2007-01)
<b>Vibration resistance</b>	EN 60068-2-6 (1995-04)
<b>Shock resistance</b>	EN 60068-2-27 (1993-03)
<b>Ambient operating temperature</b>	0 °C ... +50 °C
<b>Storage temperature</b>	-30 °C ... +70 °C
<b>Ambient light immunity</b>	40,000 lx

#### General notes

<b>Note on use</b>	Not suitable for personnel protection
--------------------	---------------------------------------

**Dimensional drawing** (Dimensions in mm (inch))

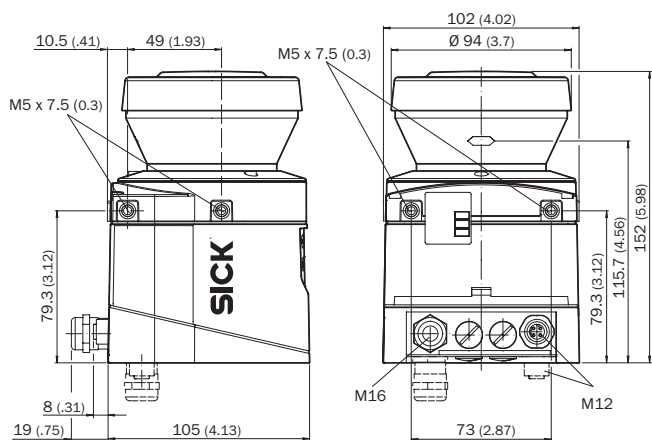

**Operating range diagram**

Scanning range in m (ft)

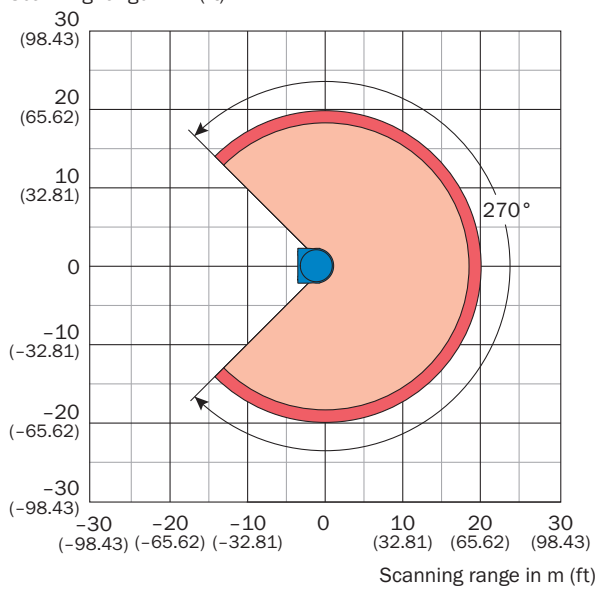





- Scanning range max. 20 m (65.62 ft)
- Scanning range for objects up to 10 % remission 18 m (59.06 ft)

**Recommended accessories**

Other models and accessories → [www.sick.com/LMS1xx](http://www.sick.com/LMS1xx)

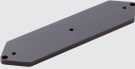
Brief description	Type	Part no.
Mounting brackets and mounting plates		

	Brief description	Type	Part no.
	1 piece, mounting bracket for rear mounting on wall or machine	Mounting kit 1a	2034324
	1 piece, mounting bracket for rear mounting on wall or machine with protection of optics hood	Mounting kit 1b	2034325
	1 piece, mounting bracket, adjustable lateral axis, only in conjunction with mounting kit 1a (2034324) or 1b (2034325)	Mounting kit 2	2039302
	1 piece, mounting plate, adjustable longitudinal axis, only in conjunction with mounting kit 2 (2039302)	Mounting kit 3	2039303
Plug connectors and cables			
	Head A: cable Head B: cable Cable: PVC, unshielded On 100 m reel	Connecting cable	6030795
	Head A: male connector, M12, 4-pin, straight, D-coded Head B: male connector, RJ45, 8-pin, straight Cable: Ethernet, drag chain use, PUR, shielded, 5 m	SSL-2J04-G05ME	6034415

## SICK AT A GLANCE

SICK is one of the leading manufacturers of intelligent sensors and sensor solutions for industrial applications. A unique range of products and services creates the perfect basis for controlling processes securely and efficiently, protecting individuals from accidents and preventing damage to the environment.

We have extensive experience in a wide range of industries and understand their processes and requirements. With intelligent sensors, we can deliver exactly what our customers need. In application centers in Europe, Asia and North America, system solutions are tested and optimized in accordance with customer specifications. All this makes us a reliable supplier and development partner.

Comprehensive services complete our offering: SICK LifeTime Services provide support throughout the machine life cycle and ensure safety and productivity.

For us, that is “Sensor Intelligence.”

## WORLDWIDE PRESENCE:

Contacts and other locations –[www.sick.com](http://www.sick.com)