



PLG3-360F431

PLG

SWITCHING AUTOMATION LIGHT GRIDS

SICK
Sensor Intelligence.



Ordering information

Type	Part no.
PLG3-360F431	1029131

Other models and accessories → www.sick.de/PLG



Detailed technical data

Features

Technology	Retro-reflective light grid
Minimum detectable object (MDO)	Parallel beam, 35 mm
Beam separation	30 mm
Number of beams	≥ 13
Detection height	360 mm

Performance

Maximum range (reflective tape REF-PLG)	≤ 1.5 m
Maximum range (PL150)	≤ 2 m
Minimum range	≥ 100 mm
Working range (reflective tape REF-PLG)	1 m
Working range (PL150)	1.3 m
Response time	Parallel beam > 100 ms ¹⁾

¹⁾ With resistive load.

Interfaces

Switching output	1 x PNP (Q)
Connection type	Short cable (0.28 m) with connector M12, 4-pin
Job LED input	PNP
Input current	12 mA

Mechanics/electronics

Wave length	650 nm
Supply voltage V_s	DC 15 V ... 30 V ¹⁾
Power consumption sender	< 45 mA
Ripple	< 5 V_{pp}

¹⁾ Typical value.

²⁾ Q = active, if at least one beam is interrupted, /Q = active, if all of the beams are free.

Output current I_{\max}.	≤ 100 mA
Output load capacitive	100 nF
Output load inductive	1 H
Initialization time	0.6 s
Dimensions (W x H x D)	35.6 mm x 429 mm x 19 mm
Housing material	Aluminum
Indication	LED
Enclosure rating	IP 54
Circuit protection	U_V connections, reverse polarity protected, Output Q short-circuit protected, Interference pulse suppression
Weight	≥ 450 g
Front screen	PMMA
Output mode	Q dark switching ²⁾
Current consumption job LED	10 mA ¹⁾

¹⁾ Typical value.

²⁾ Q = active, if at least one beam is interrupted, /Q = active, if all of the beams are free.

Ambient data

Protection class	III
EMC	EN 60947-5-2
Ambient temperature	Operation: -10 °C ... +55 °C Storage: -40 °C ... +70 °C
Vibration resistance	5 g, 10 Hz ... 55 Hz (IEC 68-2-6)
Shock load	10 g / DIN EN 60068-2-29 / 16 ms

Dimensional drawing (Dimensions in mm (inch))

PLG3

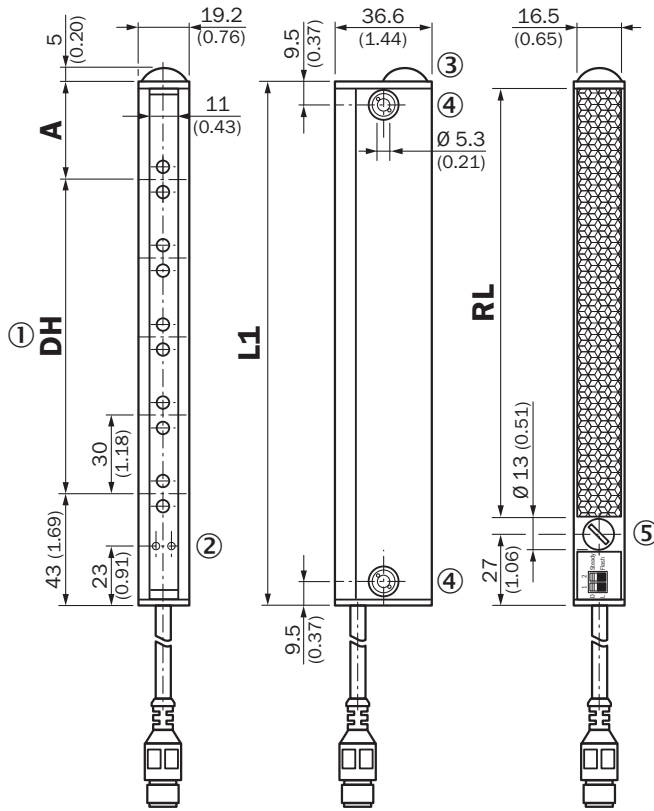

DH	A	L1	RL
120 (4.72)	36 (1.42)	199 (7.83)	162 (6.38)
210 (8.27)	26 (1.02)	279 (10.98)	242 (9.53)
270 (10.63)	36 (1.42)	349 (13.74)	312 (12.28)
360 (14.17)	26 (1.02)	429 (16.89)	392 (15.43)
420 (16.54)	36 (1.42)	499 (19.65)	462 (18.19)

- ① Detection height (DH)
- ② Indicator Power on: green; beam status: yellow
- ③ Job LED, green
- ④ Mounting hole, Ø 5.3 mm
- ⑤ Configuration switches

Adjustments

PLG3

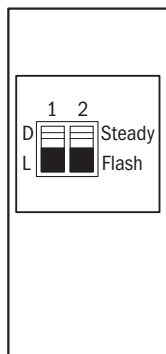

Configuration over switches

Switch 1	D	Output active, in case of blocked beams
	L	Output inactive, in case of blocked beams
Switch 2	Steady	Job-LED steady
	Flash	Job-LED flashes, 3 Hz

Connection type and diagram

M12, 4-pin male connector

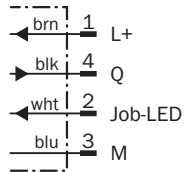
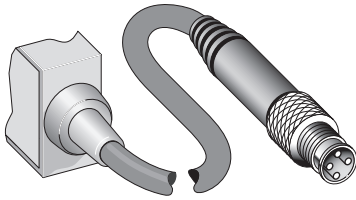

Concept of operation

Easy installation

1. Easy mounting on to different profiles

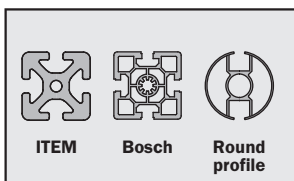

The light grid can be mounted on different profiles, e.g. ITEM, Bosch, round profile.

2. Easy installation with slot nuts



The PLG can easily be mounted on the profile with slot nuts.

Plug & play

1. Plug in and tighten the ring of the connector

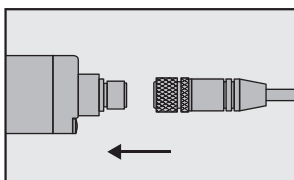

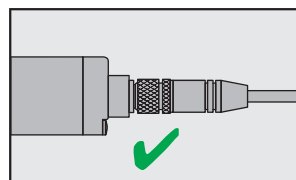

2. Device is ready for use



Recommended accessories

Other models and accessories → www.sick.de/PLG

Brief description	Type	Part no.
Other mounting accessories		

	Brief description	Type	Part no.
	Sliding nuts with spring metal ball for ITEM profile, 2x slot 6 and slot 8, including mounting material, Mounting hardware included with every 2 x slot 6 and slot 8	BEF-NSIT-PLG	2041045
Plug connectors and cables			
	Head A: female connector, M12, 4-pin, straight Head B: cable Cable: PVC, unshielded, 5 m	DOL-1204-G05M	6009866
Reflectors			
	On aluminum profile for PLG, 16.5 mm x 194.3 mm, 2 hole mounting, Screw-on, 2 hole mounting	REF-PLG120	1029196
	Reflective tape on aluminium profile, 16.5 mm x 274.3 mm, 2 hole mounting, Screw-on, 2 hole mounting	REF-PLG210	1029197
	Reflective tape on aluminium profile, 16.5 mm x 344.3 mm, 2 hole mounting, Screw-on, 2 hole mounting	REF-PLG270	1029198
	Reflective tape on aluminium profile, 16.5 mm x 424.3 mm, 2 hole mounting, Screw-on, 2 hole mounting	REF-PLG360	1029199
	Reflective tape on aluminium profile, 16.5 mm x 494.3 mm, 2 hole mounting, Screw-on, 2 hole mounting	REF-PLG420	1029200

SICK AT A GLANCE

SICK is one of the leading manufacturers of intelligent sensors and sensor solutions for industrial applications. A unique range of products and services creates the perfect basis for controlling processes securely and efficiently, protecting individuals from accidents and preventing damage to the environment.

We have extensive experience in a wide range of industries and understand their processes and requirements. With intelligent sensors, we can deliver exactly what our customers need. In application centers in Europe, Asia and North America, system solutions are tested and optimized in accordance with customer specifications. All this makes us a reliable supplier and development partner.

Comprehensive services complete our offering: SICK LifeTime Services provide support throughout the machine life cycle and ensure safety and productivity.

For us, that is “Sensor Intelligence.”

WORLDWIDE PRESENCE:

Contacts and other locations –www.sick.com