

**NEW**  
**Automotive Digital Camera Compatible Connector**

CONNECTOR

**MX55 Series**

MB-0305-1

October 2015

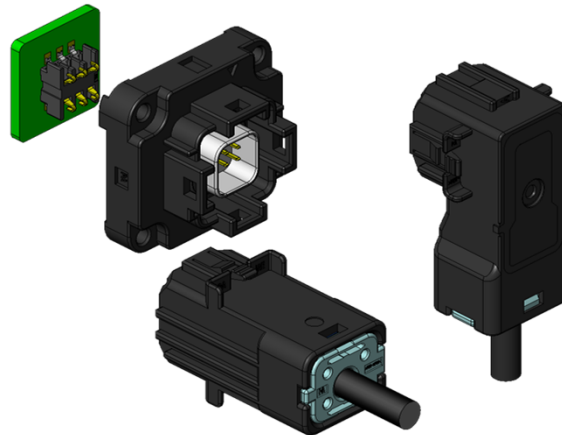

Historically automotive camera modules have utilized analog image data, mainly for rear and surround-view cameras.

Recently, demands for on-board camera modules have increased in North American and European markets due to laws and regulations. Especially digital camera modules for ADAS (Automotive Driver Assistance System) sensing applications are expanding demand.

To meet these demands, JAE has developed the MX55 Series automotive digital camera compatible connector. The MX55 Series connector satisfies the LVDS high-speed differential signal transmission performance, as well as having environmental resistance required of an automotive connector.

### Features

- Transmission characteristics ideal for LVDS.
- Surface of the connector is covered with a shielded shell for EMI prevention.
- Superior waterproof performance. (IP69K when mated and rear case 100kPa as an individual product)
- 2.2mm side pitch, 2 rows, 6 pos. (2 pos. for differential signal + 1 pos. for power + 1 pos. for ground + 2 pos. for option)
- SMT type PCB connector.
- Cable connector is offered in both straight type and right angle types. (cable pull-out directions can be set in 4 orientations)
- Mechanical lock and twist-resistant structure for mated connectors.
- Available as a completed harness to ensure transmission performance reliability.

### General Specifications

- No. of Contact: 4-position (cable side), 6-position (PCB side)
- Dielectric Withstanding Voltage: AC500V, applied for 1 minute (when mated)
- Operating Temperature: -40 Deg. C to +85 Deg. C
- Insulation Resistance: 100M $\Omega$  min. (when mated)
- Applicable Board Thickness: 1.6mm min.
- Applicable Cable: Shielded Twisted Quad (STQ) cable. (sold as harness product)
- Connector Insertion Force: 70N max.

Materials and Finishes
------------------------

■ PCB Connector: 6 pos.

Component	Material / Finish
Terminal	Copper alloy / Contact area: Au plating over Ni Board connection area: Sn plating
Housing	LCP-GF35

■ Rear Case Connector: 6 pos.

Component	Material / Finish
Terminal	Copper alloy / Contact area: Au plating over Ni
Outer Housing	PA-GF33
Inner Housing	PA-GF33
GND Shell	Steel / Sn plating
Seal Rubber	Synthetic Rubber
Potting	Synthetic Resin

### ■ Cable Connector (Straight): 6 pos.

Component	Material / Finish
Terminal	Copper alloy / Contact area: Au plating over Ni Cable connection area: Sn plating
Outer Housing	PBT-GF30
Inner Housing	PBT-GF30
Inner Cover	PBT-GF30
Retainer	PBT-GF30
GND Shell	Copper alloy / Sn plating
Cover Shell	Brass / Sn plating
Grommet	Silicone Rubber
Sleeve	Brass / Sn plating
Conductive Tape	—

### ■ Cable Connector (Right Angle): 6 pos.

Component	Material / Finish
Terminal	Copper alloy / Contact area: Au plating over Ni Cable connection area: Sn plating
Outer Housing	PBT-GF30
Inner Housing	PBT-GF30
Inner Cover	PBT-GF30
Retainer	PBT-GF30
GND Shell	Copper alloy / Sn plating
Cover Shell	Brass / Sn plating
Grommet	Silicone Rubber
Sleeve	Brass / Sn plating
Cover Housing	PBT-GF30
Outer Cover	Synthetic Resin
Conductive Tape	—

Outer Dimensions

■ PCB Connector (MX55006KQ1)

Drawing No.: SJ114294-1

Unit: mm

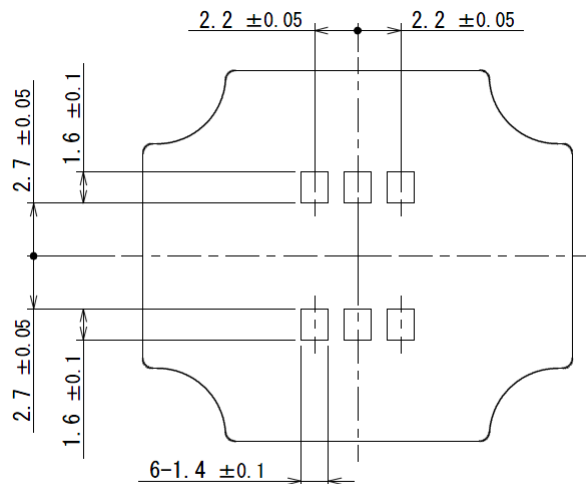
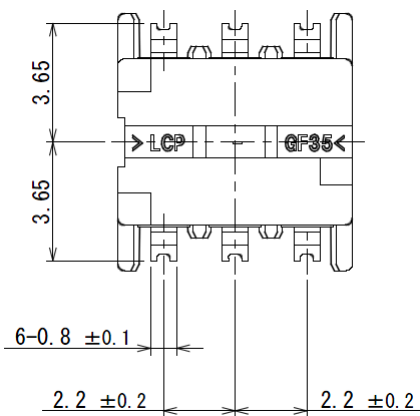
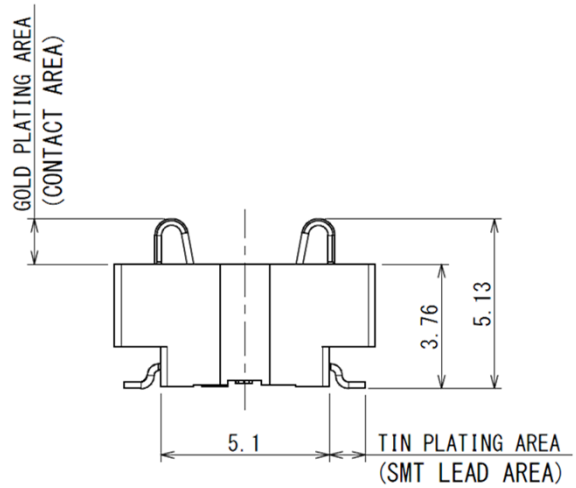
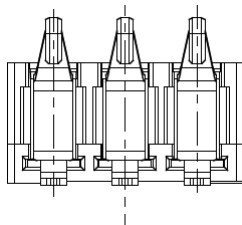
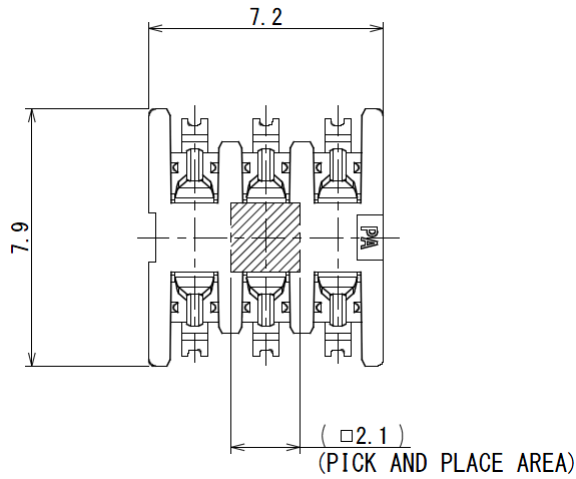

APPLICABLE P. C. B. DIMENSION (REF.)

■ Rear Case Connector (MX55A06ZB2)

Drawing No.: SJ116527

Unit: mm

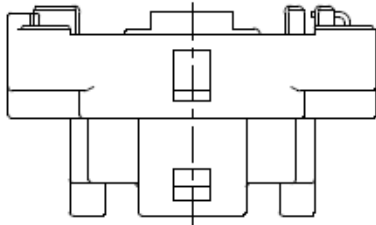

Note) Please contact us if you have inquiries and requests for custom orders for GND shell and outer housing for the rear case connectors.

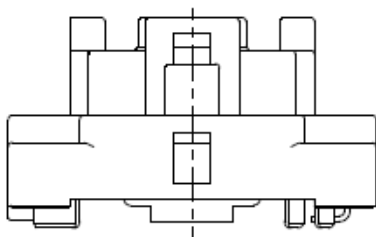
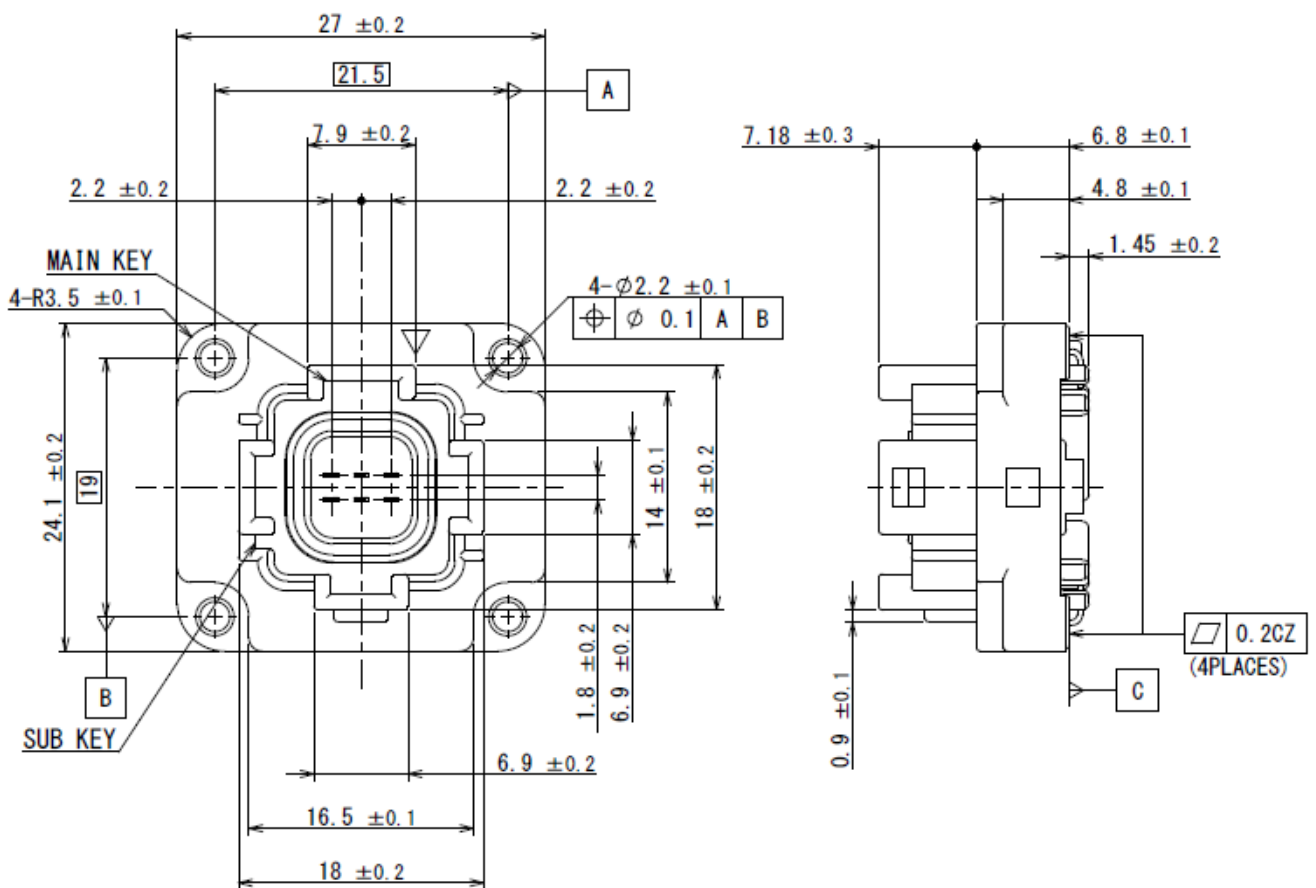

■ Cable Connector: Straight (MX55A04SB5)

Drawing No. : SJ113971

Unit: mm

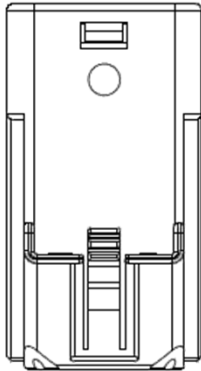

Note) Cable connector is to be sold as a harnessed product ,not as an individual product.

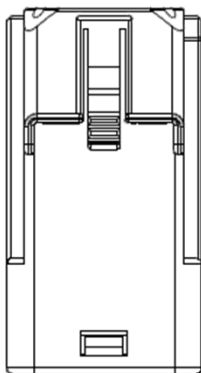
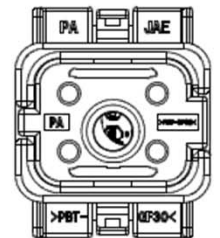
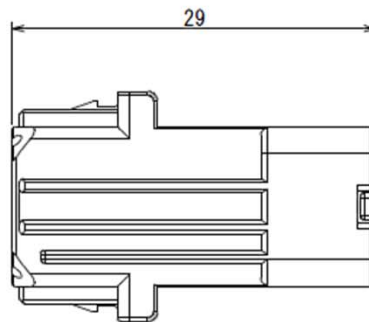
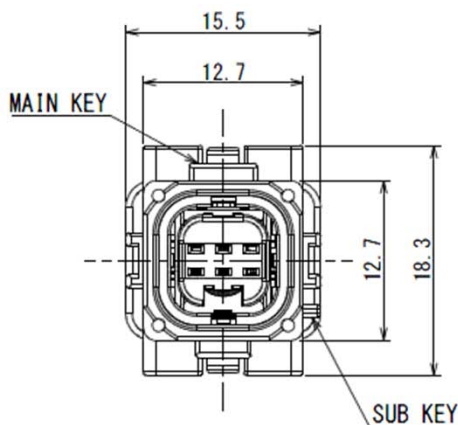

## ■ Cable Connector : Right Angle (MX55A04SB6)

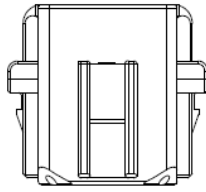

Drawing No.: SJ116533 Unit: mm

Note ) Cable connector is to be sold as a harnessed product, not as an individual product.

Also, please contact us when using a cable connector (angle type).

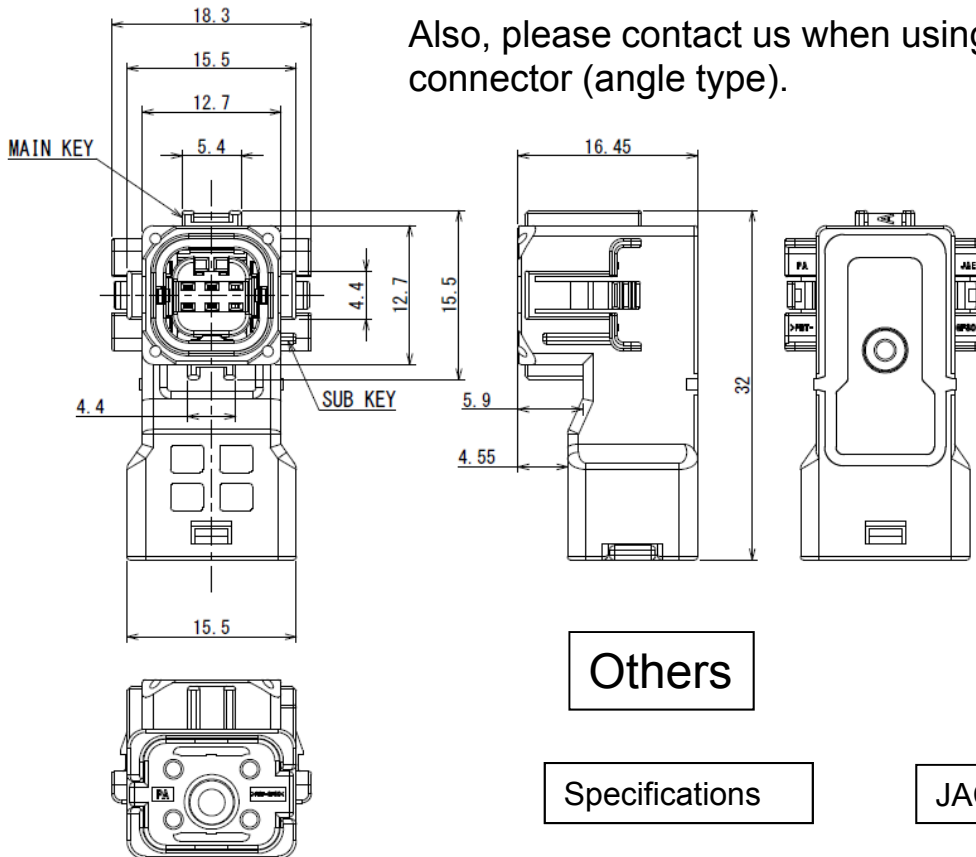

Others

Specifications

JACS-11107

### Notice:

- The values specified in this brochure are only for reference. The products and their specifications are subject to change without notice. Contact our sales staff for further information before considering or ordering any of our products. For purchase, a product specification must be agreed upon.
- Users are requested to provide protection circuits and redundancy circuits to ensure safety of the equipment, and sufficiently review the suitability of JAE's products to the equipment.
- The products presented in this brochure are designed for the uses recommended below. We strongly suggest you contact our sales staff when considering use of any of the products in any other way than the recommended applications or for a specific use that requires an extremely high reliability.
  - Applications that require consultation:
    - Please contact us if you are considering use involving a quality assurance program that you specify or that is peculiar to the industry, such as:  
Automotive electrical components, train control, telecommunications devices (mainline), traffic light control, electric power, combustion control, fire prevention or security systems, disaster prevention equipment, etc.
    - We may separately give you our support with a quality assurance program that you specify, when you think of a use such as :  
Aviation or space equipment, submarine repeaters, nuclear power control systems, medical equipment for life support, etc.
  - Recommended applications include:  
Computers, office appliances, telecommunications devices (terminals, mobile units), measuring equipment, audiovisual equipment, home electric appliances, factory automation equipment, etc.

### Japan Aviation Electronics Industry, Limited

Product Marketing Division  
Aobadai Building, 3-1-19, Aobadai, Meguro-ku, Tokyo 153-8539  
Phone: +81-3-3780-2882 FAX: +81-3-3780-2946

\* The specifications in this brochure are subject to change without notice. Please contact JAE for information.