

Standard Rectifier

$$V_{RRM} = 2 \times 1200V$$

$$I_{FAV} = 45A$$

$$V_F = 1.23V$$

Phase leg

Part number

DSP45-12A

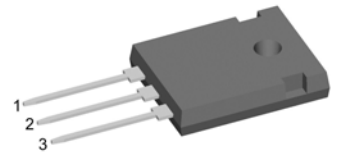

Backside: anode/cathode

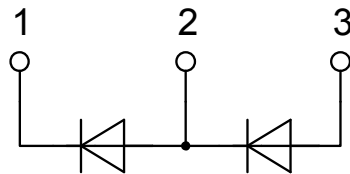

Features / Advantages:

- Planar passivated chips
- Very low leakage current
- Very low forward voltage drop
- Improved thermal behaviour

Applications:

- Diode for main rectification
- For single and three phase bridge configurations

Package: TO-247

- Industry standard outline
- RoHS compliant
- Epoxy meets UL 94V-0

Rectifier				Ratings			
Symbol	Definition	Conditions	min.	typ.	max.	Unit	
V_{RSM}	max. non-repetitive reverse blocking voltage	$T_{VJ} = 25^{\circ}C$			1300	V	
V_{RRM}	max. repetitive reverse blocking voltage	$T_{VJ} = 25^{\circ}C$			1200	V	
I_R	reverse current	$V_R = 1200 V$	$T_{VJ} = 25^{\circ}C$		40	μA	
		$V_R = 1200 V$	$T_{VJ} = 150^{\circ}C$		1.5	mA	
V_F	forward voltage drop	$I_F = 45 A$	$T_{VJ} = 25^{\circ}C$		1.26	V	
					1.57	V	
		$I_F = 90 A$	$T_{VJ} = 150^{\circ}C$		1.23	V	
					1.66	V	
I_{FAV}	average forward current	$T_C = 130^{\circ}C$ 180° sine	$T_{VJ} = 175^{\circ}C$		45	A	
V_{FO}	threshold voltage	} for power loss calculation only	$T_{VJ} = 175^{\circ}C$		0.81	V	
r_F	slope resistance				9.1	m Ω	
R_{thJC}	thermal resistance junction to case				0.55	K/W	
R_{thCH}	thermal resistance case to heatsink			0.25		K/W	
P_{tot}	total power dissipation		$T_C = 25^{\circ}C$		270	W	
I_{FSM}	max. forward surge current	t = 10 ms; (50 Hz), sine	$T_{VJ} = 45^{\circ}C$		480	A	
					520	A	
		t = 8,3 ms; (60 Hz), sine	$V_R = 0 V$	$T_{VJ} = 150^{\circ}C$		410	A
						440	A
I^2t	value for fusing	t = 10 ms; (50 Hz), sine	$T_{VJ} = 45^{\circ}C$		1.15	kA ² s	
					1.13	kA ² s	
		t = 8,3 ms; (60 Hz), sine	$V_R = 0 V$	$T_{VJ} = 150^{\circ}C$		840	A ² s
						805	A ² s
C_J	junction capacitance	$V_R = 400 V; f = 1 MHz$	$T_{VJ} = 25^{\circ}C$		18	pF	

Package TO-247			Ratings			
Symbol	Definition	Conditions	min.	typ.	max.	Unit
I_{RMS}	RMS current	per terminal			70	A
T_{VJ}	virtual junction temperature		-40		175	°C
T_{op}	operation temperature		-40		150	°C
T_{stg}	storage temperature		-40		150	°C
Weight				6		g
M_D	mounting torque		0.8		1.2	Nm
F_C	mounting force with clip		20		120	N

Product Marking

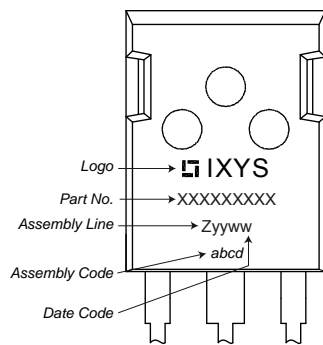

Ordering	Part Number	Marking on Product	Delivery Mode	Quantity	Code No.
Standard	DSP45-12A	DSP45-12A	Tube	30	480673

Similar Part	Package	Voltage class
DSP45-12AZ	TO-268AA (D3Pak) (2HV)	1200
DSP45-16A	TO-247AD (3)	1600
DSP45-16AZ	TO-268AA (D3Pak) (2HV)	1600
DSP45-16AR	ISOPLUS247 (3)	1600
DSP45-18A	TO-247AD (3)	1800

Equivalent Circuits for Simulation

* on die level

$T_{VJ} = 175\text{ °C}$

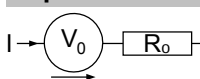

Rectifier

$V_{0\ max}$	threshold voltage	0.81	V
$R_{0\ max}$	slope resistance *	6.5	mΩ

Outlines TO-247

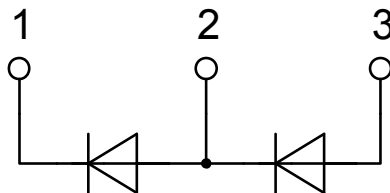
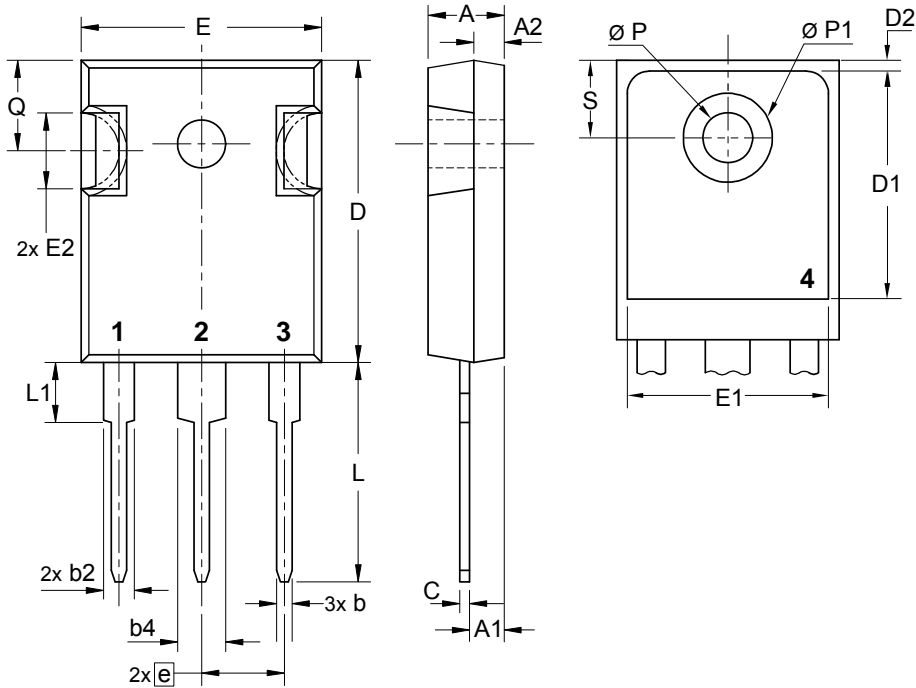

Rectifier

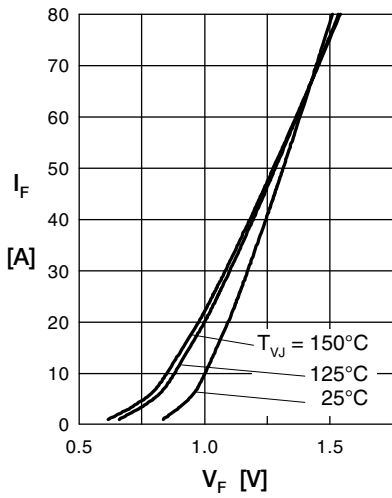

Fig. 1 Forward current versus voltage drop per diode

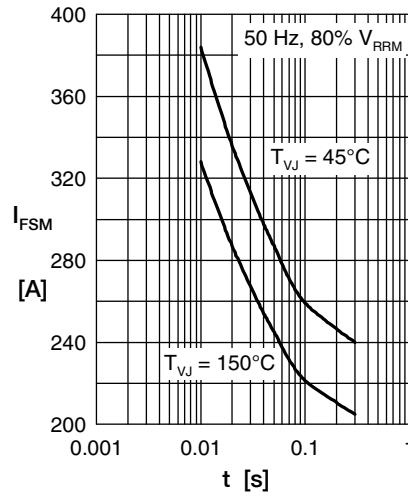

Fig. 2 Surge overload current

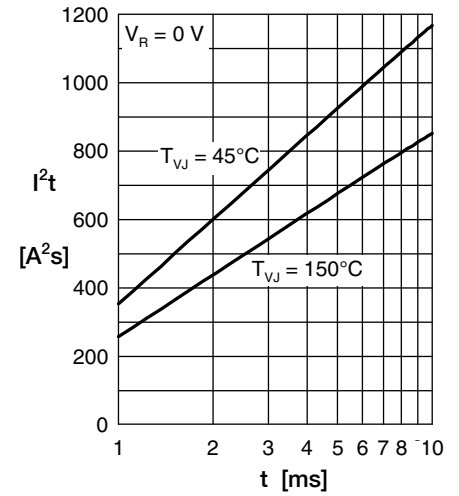

Fig. 3 I^2t versus time per diode

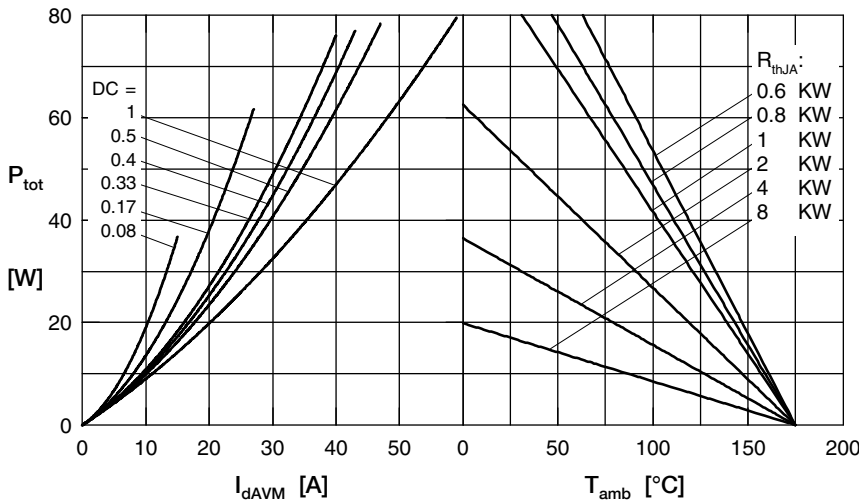

Fig. 4 Power dissipation vs. direct output current & ambient temperature

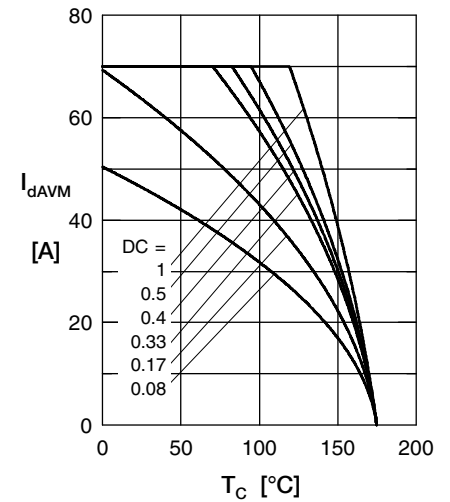

Fig. 5 Max. forward current vs. case temperature

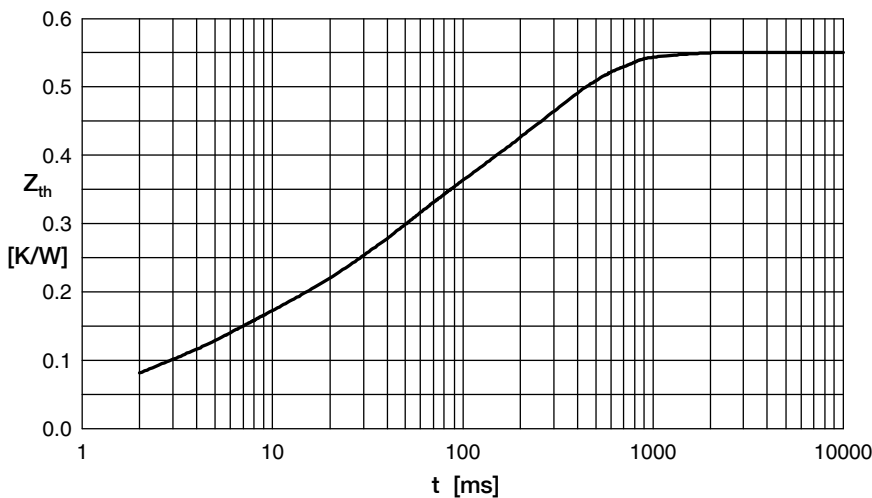

Fig. 6 Transient thermal impedance junction to case

i	R_i	t_i
1	0.033	0.0006
2	0.095	0.0039
3	0.164	0.033
4	0.258	0.272