



MBRD10150CT

Schottky Barrier Rectifier

Reverse Voltage 150 Volts Forward Current 10 Amperes

Features

- Plastic package has underwriters Laboratory Flammability Classification 94V-0
- Dual rectifier construction, positive center tap
- Metal of silicon rectifier, majority carrier conduction
- Low forward voltage, high efficiency
- Guarding for over voltage protection

TO-252 (D-PAK)

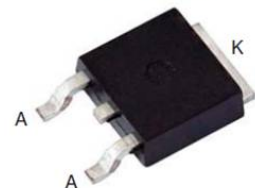

Package: TO-252(D-PAK)



Mechanical Data

- Case: Epoxy, Molded
- Weight: 0.4grams (approximately)
- Finish: All External Surfaces Corrosion Resistant and Terminal Leads are Readily Solderable
- Lead Temperature for Soldering Purposes: 260°C Max. for 10 sec
- Shipped 2500 units per reel

Maximum Ratings & Electrical Characteristics

($T_A=25^{\circ}\text{C}$ unless otherwise noted)

PARAMETER	TEST CONDITIONS		SYMBOL	MBRD10150CT	UNIT
Maximum repetitive peak reverse voltage			V_{RRM}	150	V
Working peak reverse voltage			V_{RWM}	150	V
Maximum DC blocking voltage			V_{DC}	150	V
Maximum average forward rectified current at $T_c=105^{\circ}\text{C}$ total device / per diode			$I_F(AV)$	10 5	A
Peak forward surge current 8.3ms single half sine-wave superimposed on rated load per diode			I_{FSM}	120	A
Peak repetitive reverse current per leg at $t_p=2.0\mu\text{s}$, 1KHz			I_{RRM}	1.0	A
Voltage rate of change (rated V_R)			DV/dt	10000	V/us
Operating junction temperature range			T_J	-55 to+150	$^{\circ}\text{C}$
Storage temperature range			T_{STG}	-55 to+150	$^{\circ}\text{C}$
Maximum instantaneous forward voltage per leg	$I_F=5\text{A}$ $I_F=5\text{A}$	$T_C=25^{\circ}\text{C}$ $T_C=125^{\circ}\text{C}$	V_F	0.92 0.82	V
Maximum reverse current per leg at working peak Reverse voltage			I_R	200 15	μA mA
Thermal Characteristics $T_A=25^{\circ}\text{C}$ unless otherwise noted					
Symbol	Parameter		TYP (TO-252)		Unit
R θ JC	Thermal Resistance, Junction to Case per Leg		3.5		$^{\circ}\text{C}/\text{W}$
R θ JA	Thermal Resistance, Junction to Ambient per Leg		62.5		$^{\circ}\text{C}/\text{W}$

Note: Pulse test:300us pulse width, duty cycle=2%



MBRD10150CT

Schottky Barrier Rectifier

Reverse Voltage 150 Volts Forward Current 10 Amperes

Ratings and Characteristics Curves

($T_A = 25^\circ\text{C}$ unless otherwise noted)

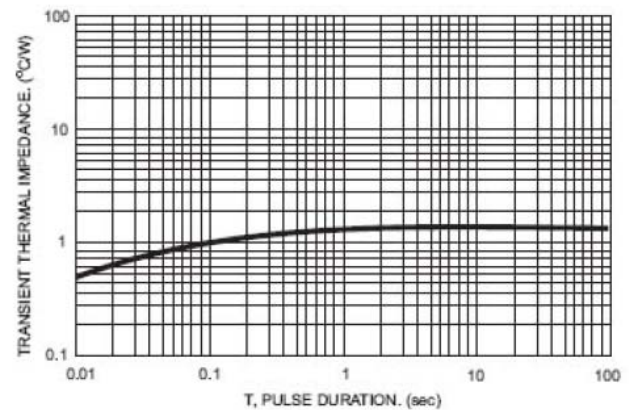
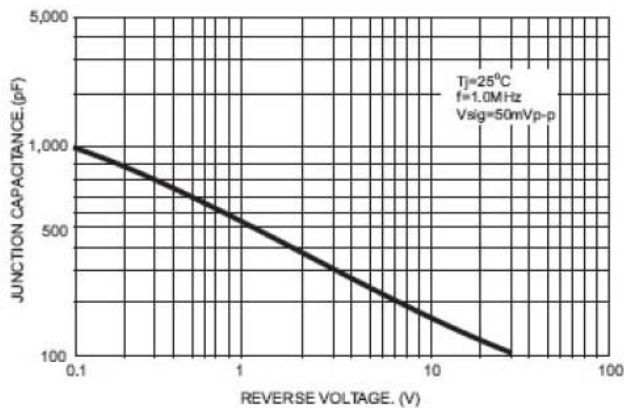
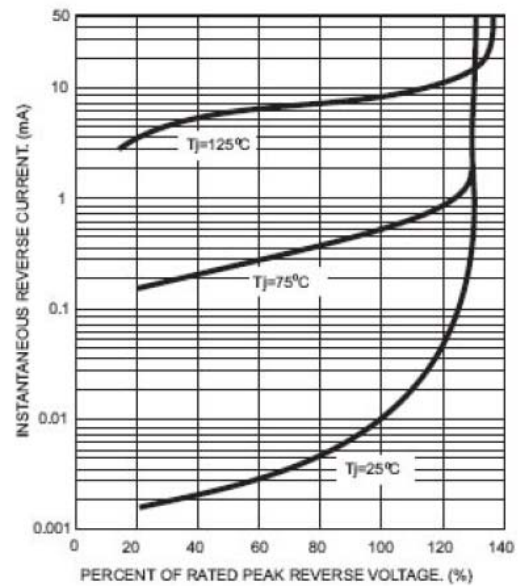
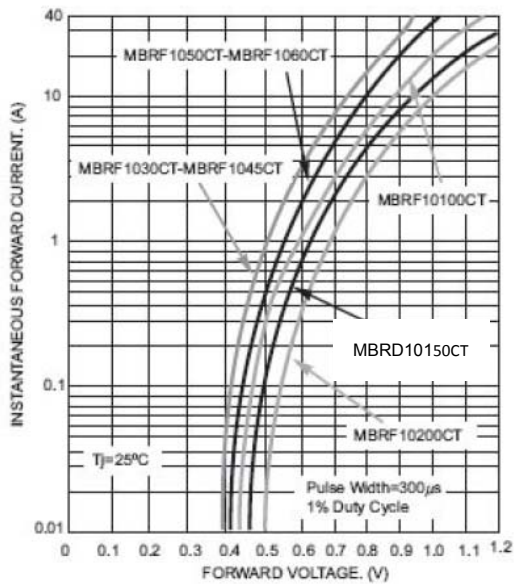
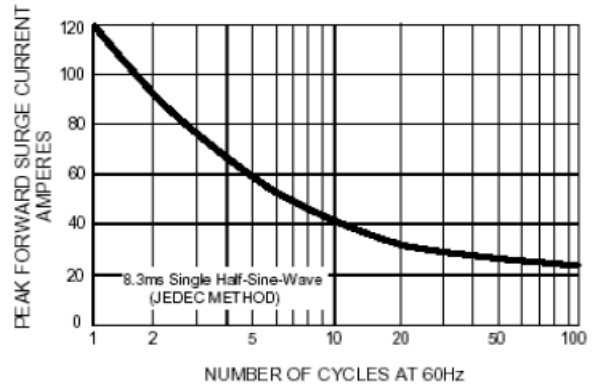
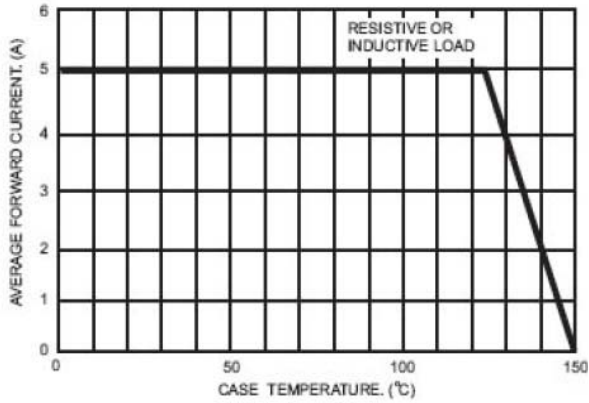



MBRD10150CT

Schottky Barrier Rectifier

Reverse Voltage 150 Volts Forward Current 10 Amperes

Package Outline Dimensions

Unit: millimeters

TO-252(D-PAK)

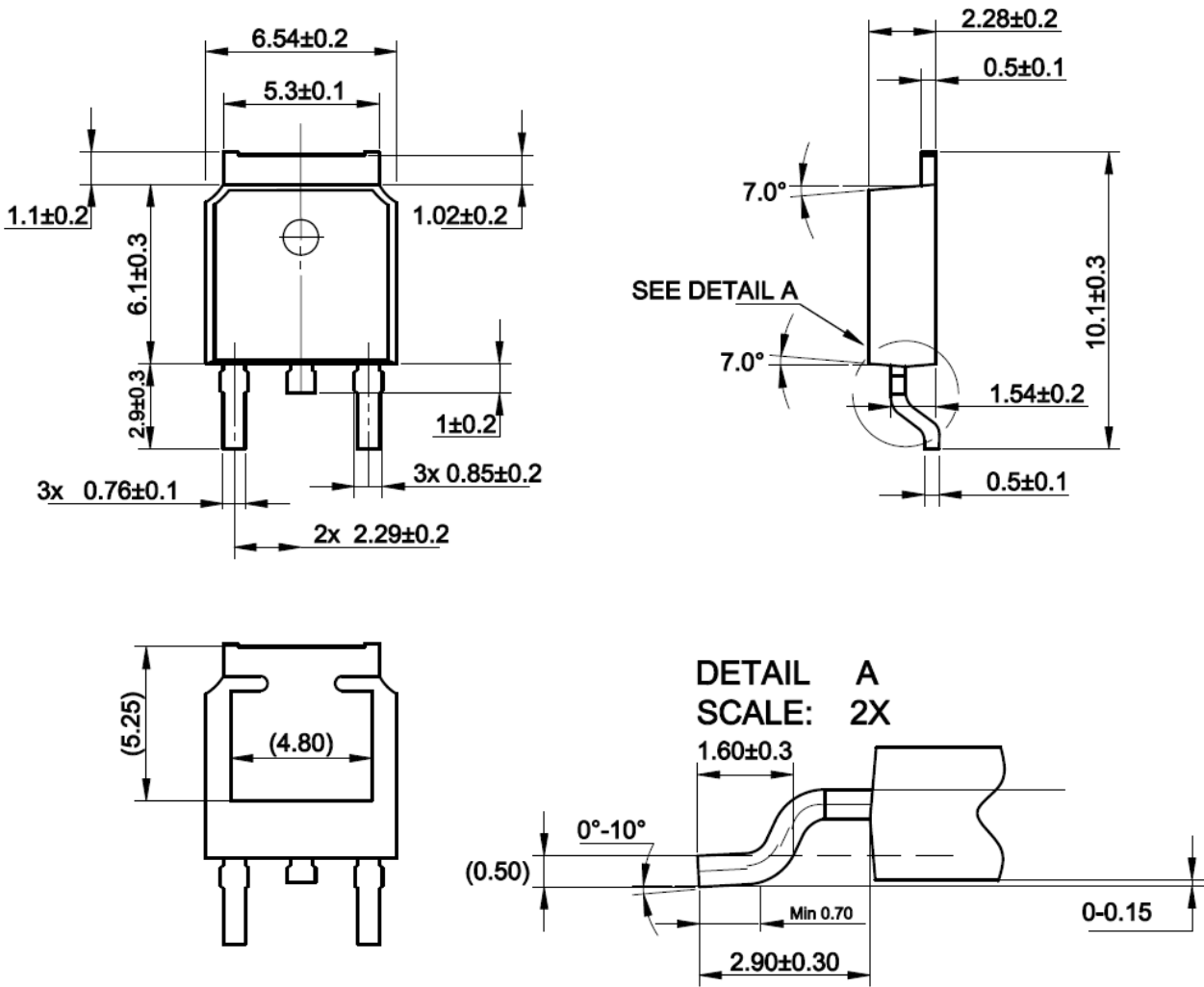



MBRD10150CT

Schottky Barrier Rectifier

Reverse Voltage 150 Volts Forward Current 10 Amperes

Disclaimers

These materials are intended as a reference to assist our customers in the selection of the Suzhou Goo-Ark product best suited to the customer's application; they do not convey any license under any intellectual property rights, or any other rights, belonging to Suzhou Good-Ark Electronics Co., Ltd. or a third party.

Suzhou Good-Ark Electronics Co., Ltd. assumes no responsibility for any damage, or infringement of any third-party's rights, originating in the use of any product data, diagrams, charts, programs, algorithms, or circuit application examples contained in these materials.

All information contained in these materials, including product data, diagrams, charts, programs and algorithms represents information on products at the time of publication of these materials, and are subject to change by Suzhou Good-Ark Electronics Co., Ltd. without notice due to product improvements or other reasons. It is therefore recommended that customers contact Suzhou Good-Ark Electronics Co., Ltd. or an authorized Suzhou Good-Ark Electronics Co., Ltd. for the latest product information before purchasing a product listed herein. The information described here may contain technical inaccuracies or typographical errors. Suzhou Good-Ark Electronics Co., Ltd. assumes no responsibility for any damage, liability, or other loss rising from these inaccuracies or errors. Please also pay attention to information published by Suzhou Good-Ark Electronics Co., Ltd. by various means, including our website home page.
(<http://www.goodark.com>)

When using any or all of the information contained in these materials, including product data, diagrams, charts, programs, and algorithms, Please be sure to evaluate all information as a total system before making a final decision on the applicability of the information and products. Suzhou Good-Ark Electronics Co., Ltd. assumes no responsibility for any damage, liability or other loss resulting from the information contained herein.

The prior written approval of Suzhou Good-Ark Electronics Co., Ltd. is necessary to reprint or reproduce in whole or in part these materials.

Please contact Suzhou Good-Ark Electronics Co., Ltd. or an authorized distributor for further details on these materials or the products contained herein.