

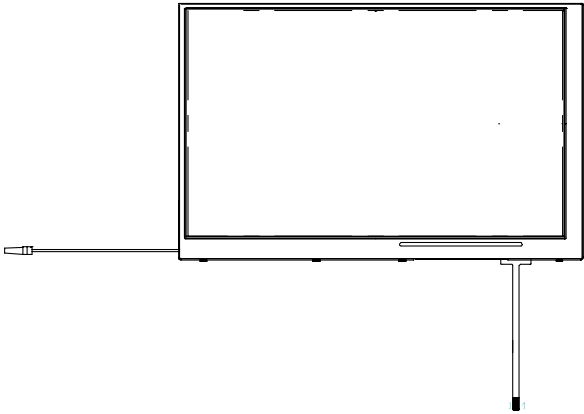

PRODUCT SPECIFICATION

**HDA700LT-2S1**

7", TFT WVGA (800X480) COLOR  
LCD DISPLAY MODULE



HANTRONIX, INC. 10080 BUBB RD. CUPERTINO, CA 95014	Q.A.:	REV.:	<b>HDA700LT-2S1</b>	SHEET 1 OF 19
	Z.W.	1.0		DATE: 10/15/15

## 1. General Specifications

No	Item	Contents	Unit
1	Size	7	inch
2	Resolution	800(RGB)*480	
3	Color	262	K
4	Surface Treatment	Anti-glare	
5	Viewing Direction	6:00	o'clock
6	Active Area (W x H)	152.40*91.44	mm
7	With/Without TSP	With TSP	
8	Pixel Size	190.5*190.5	um
9	Pixel Configuration	RGB Vertical Stripe	
10	LCM(W x H x D)	165.00*104.44*6.7	mm

HANTRONIX, INC.  
10080 BUBB RD.  
CUPERTINO, CA 95014

Q.A.:  
Z.W.

REV.:  
1.0

**HDA700LT-2S1**

SHEET 2 OF 19

DATE:  
10/15/15

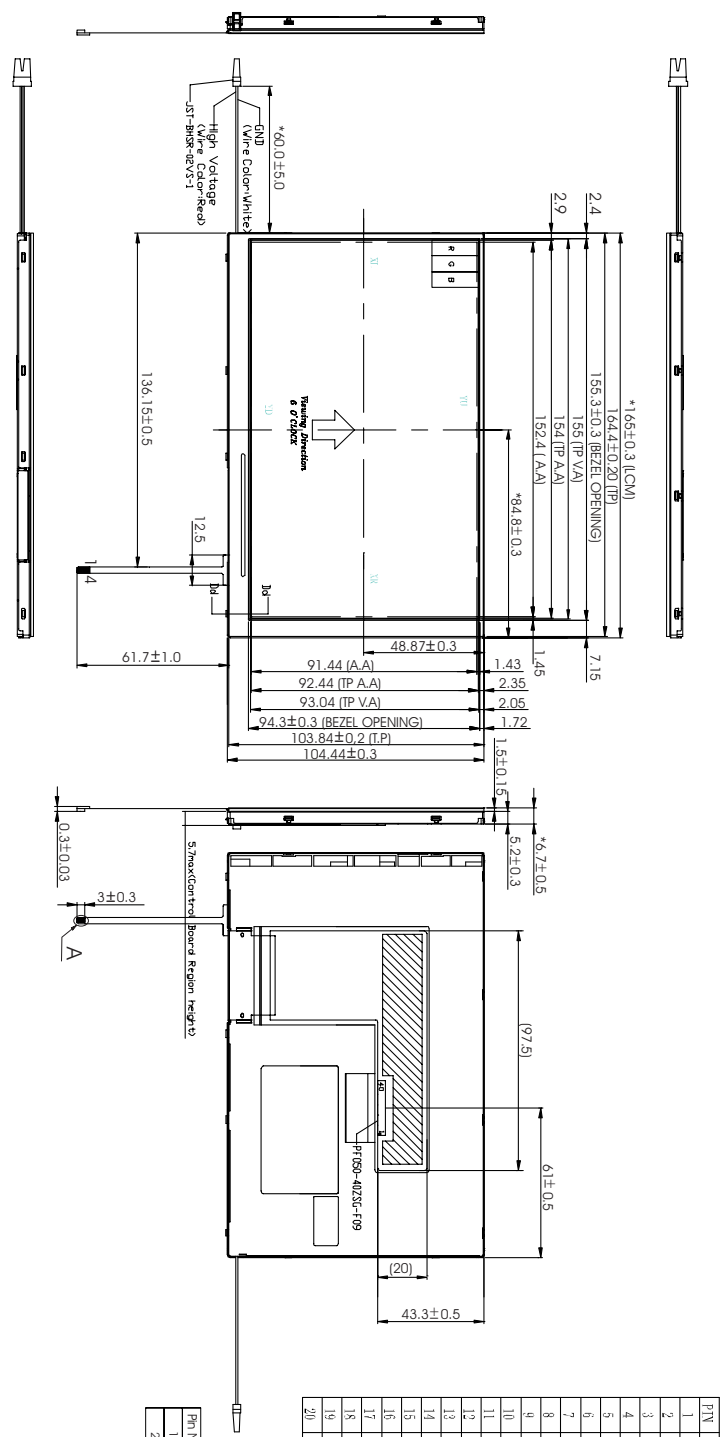

PIN SYMBOL	PIN SYMBOL
1 GND	21 G5
2 GND	22 G4
3 NC	23 G3
4 VCC	24 G70
5 VCC	25 G2
6 VCC	26 G1
7 VCC	27 G0
8 NC	28 G70
9 DE	29 G5
10 GND	30 R4
11 GND	31 R3
12 GND	32 GND
13 B5	33 R2
14 B4	34 R1
15 B3	35 R0
16 GND	36 GND
17 E2	37 GND
18 B1	38 DCLF
19 B0	39 GND
20 GND	40 GND

LED PIN

Pin No.	Symbol	Wire Color
1	VEDA	Red
2	VEDK	White

T/P PIN

Pin/OUT
1 YU
2 XU
3 YD
4 XD

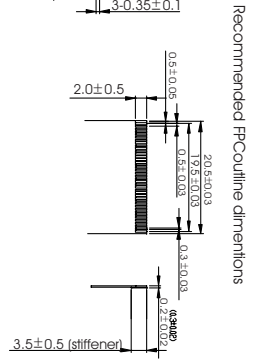

1 Operating Voltage:	Vcc=3.3V typ.
2 Resolution:	800RGB*480
3 Color:	262K
4 Interface:	RGB
5 Display Type:	Transmissive
6 Viewing Direction:	6:00
7 Operating Temp.:	-20°C~70°C
8 Storage Temp.:	-30°C~80°C
9 Driver IC:	HX3262*2, HX8678*1
10 Unspecified tolerance:	±0.2

HANTRONIX, INC.  
10080 BUBB RD.  
CUPERTINO, CA 95014

Q.A.:  
**Z.W.**

REV:  
**1.0**

**HDA700LT-2S1**

**SHEET 3 OF 19**

DATE:  
**10/15/15**

PTN	QFT
1	WI
2	XE
3	YO
4	XE

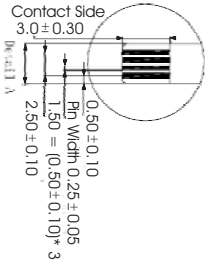
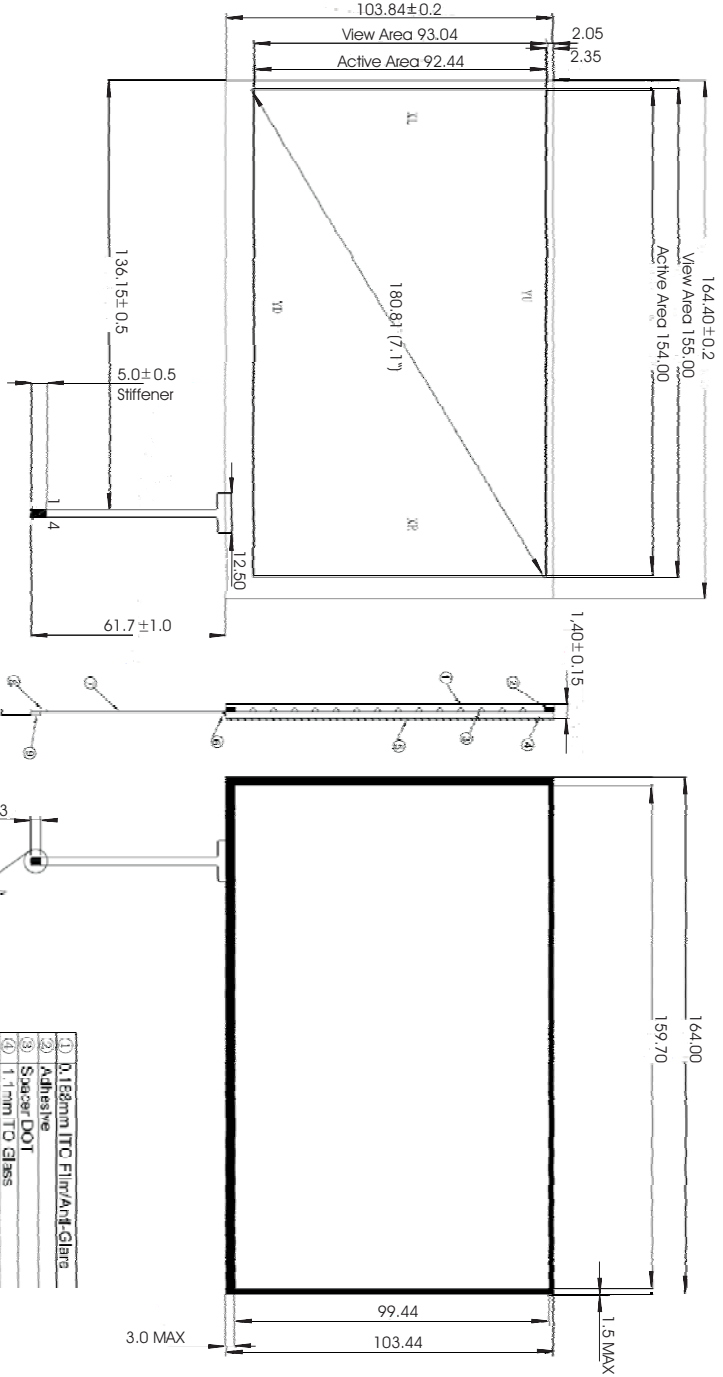

①	0.18mm ITC Film/Anti-Glare
②	Adhesive
③	Solder/DOI
④	1.1mm ITO Glass
⑤	Aluminum Double-faced Adhesive
⑥	Silicon
⑦	FPC Tail
⑧	Stiffener
⑨	Conduct Seal (导电胶)

- NOTE:
1. Unspecified Tolerance: ±0.30mm
  2. Operating force: <100g; Insulation resistance >20M Ω, 25V(DC);
  3. Linearity: ≤±1.5%;
  4. Operating environment: -30°C~+70°C;
  5. Storage environment: -30°C~+80°C;
  6. Light transparency: >75%;
  7. Connector type: FPC connect;
  8. ITO Film type: anti-glare hard coating and anti-newton ring ;
  9. Surface hardness: >3H
  10. Tapping durability: >1,000,000 times;  
Pen sliding durability: >100,000 times;
  11. Bound time: <10ms;
  12. Compliant ROHS.

HANTRONIX, INC.  
10080 BUBB RD.  
CUPERTINO, CA 95014

Q.A.:  
Z.W.

REV.:  
1.0

HDA700LT-2S1

SHEET 4 OF 19

DATE:  
10/15/15

### 3. PIN Assignment

Pin No	Symbol	Function	Remark
1	GND	Power Ground	
2	GND	Power Ground	
3	NC	No Connection	
4	Vcc	Power Supply for Digital Circuit	
5	Vcc	Power Supply for Digital Circuit	
6	Vcc	Power Supply for Digital Circuit	
7	Vcc	Power Supply for Digital Circuit	
8	NC	No Connection	
9	DE	Data Enable	
10	GND	Power Ground	
11	GND	Power Ground	
12	GND	Power Ground	
13	B5	Blue Data 5 (MSB)	
14	B4	Blue Data 4	
15	B3	Blue Data 3	
16	GND	Power Ground	
17	B2	Blue Data 2	
18	B1	Blue Data 1	
19	B0	Blue Data 0(LSB)	
20	GND	Power Ground	
21	G5	Green Data 5(MSB)	
22	G4	Green Data 4	
23	G3	Green Data 3	
24	GND	Power Ground	
25	G2	Green Data 2	
26	G1	Green Data 1	
27	G0	Green Data 0(LSB)	
28	GND	Power Ground	
29	R5	Red Data 5(MSB)	
30	R4	Green Data 4	
31	R3	Green Data 3	
32	GND	Power Ground	
33	R2	Green Data 2	
34	R1	Green Data 1	
35	R0	Green Data 0	
36	GND	Power Ground	

HANTRONIX, INC.  
10080 BUBB RD.  
CUPERTINO, CA 95014

Q.A.:  
Z.W.

REV.:  
1.0

**HDA700LT-2S1**

SHEET 5 OF 19

DATE: 10/15/15

37	GND	Power Ground	
38	DCLK	Clock Signals;Latch Data at the Falling Edge	
39	GND	Power Ground	
40	GND	Power Ground	

Touch Panel Part:

Pin No	Symbol	Function	Remark
1	YU	The pins of touch panel	
2	CL	The pins of touch panel	
3	YD	The pins of touch panel	
4	XR	The pins of touch panel	

Backlight Driving Part

Pin No	Symbol	Function	Remark
1	VLED+	Red,LED_Anode	
2	VLED-	White,LED_Cathode	

#### 4. Absolute Maximum Rating

AGND = GND = 0V, Ta = 25° C

Item	Symbol	Min	Max	Unit	Remark
Power Voltage	VCC	-0.3	6	V	
Input Logical Voltage	VI	-0.3	VCC+0.3	V	
Backlight Forward Current	I <sub>LED</sub>	-	25	mA	For each LED
Operating Temperature	T <sub>OPR</sub>	-20	70	° C	
Storage Temperature	T <sub>STG</sub>	-30	80	° C	

## 5. Electrical Characteristics

### 5.1. Recommended Operating Condition

AGND = GND = 0V, Ta = 25° C

Item	Symbol	Min	Typ	Max	Unit	Remark
Power Voltage	VCC	3.0	3.3	3.6	V	V
Input Logical Voltage	High Level	Vih	0.7VCC	-	VCC	V
	Low Level	Vil	0	-	0.3VCC	V

### 5.2. Recommended Driving Condition for Backlight

T=25°C

Item	Symbol	Min	Typ	Max	Unit	Remark
LED Current	I <sub>LED</sub>	-	160	-	mA	
LED Voltage	V <sub>LED</sub>	-	9.9	-	V	
LED Life Time	-	10000	20000	-	Hr	

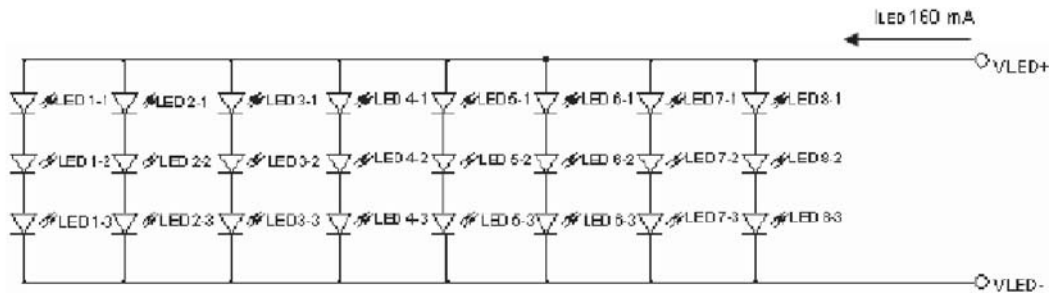

### 5.3. Power Consumption

#### TFT-LCD current consumption

Item	Symbol	Min	Typ	Max	Unit	Remark
LCD Power Current	I <sub>cc</sub>	-	200	260	mA	
LED Power Current	I <sub>led</sub>	-	160	200	mA	

HANTRONIX, INC.  
10080 BUBB RD.  
CUPERTINO, CA 95014

Q.A.:  
Z.W.

REV.:  
1.0

HDA700LT-2S1

SHEET 8 OF 19

DATE:  
10/15/15



## 6. Timing Characteristics

### 6.1. AC Electrical Characteristics

Frame rate range : 60Hz~65Hz

Parameter	Symbol	Rating			Unit
		Min.	Typ.	Max.	
Data setup time	Tdsu	6	-	-	ns
Data hold time	Tdhd	6	-	-	ns
DE setup time	Tesu	6	-	-	ns
CLK frequency	F <sub>CPH</sub>	29.40	33.26	42.48	MHz
CLK period	T <sub>CPH</sub>	23.54	30.06	34.01	ns
CLK pulse duty	T <sub>CWH</sub>	40	50	60	%
CLK pulse duty	T <sub>CWL</sub>	40	50	60	%
DE period	T <sub>DEH</sub> +T <sub>DEL</sub>	1000	1056	1200	T <sub>CPH</sub>
DE pulse width	T <sub>DEH</sub>	-	800	-	T <sub>CPH</sub>
DE frame blanking	T <sub>DEB</sub>	10	45	110	T <sub>DEH</sub> +T <sub>DEL</sub>
DE frame width	T <sub>DE</sub>	-	480	-	T <sub>DEH</sub> +T <sub>DEL</sub>

Note : We suggest using the typical value, so it can have better performance.

### Timing Controller Timing Chart

Clock and Data input waveforms

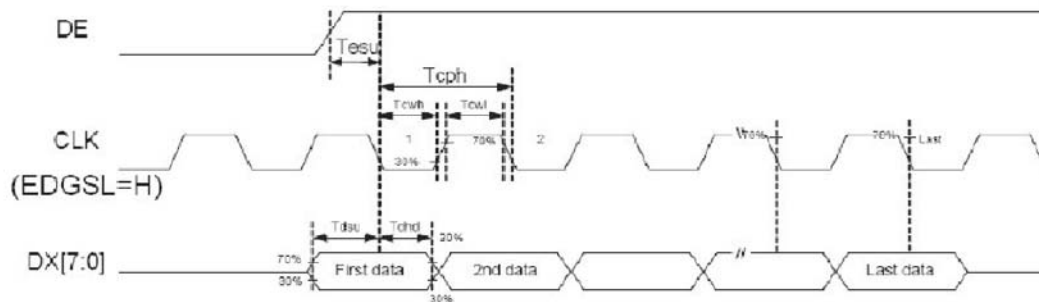

## 6.2.Data Input Format

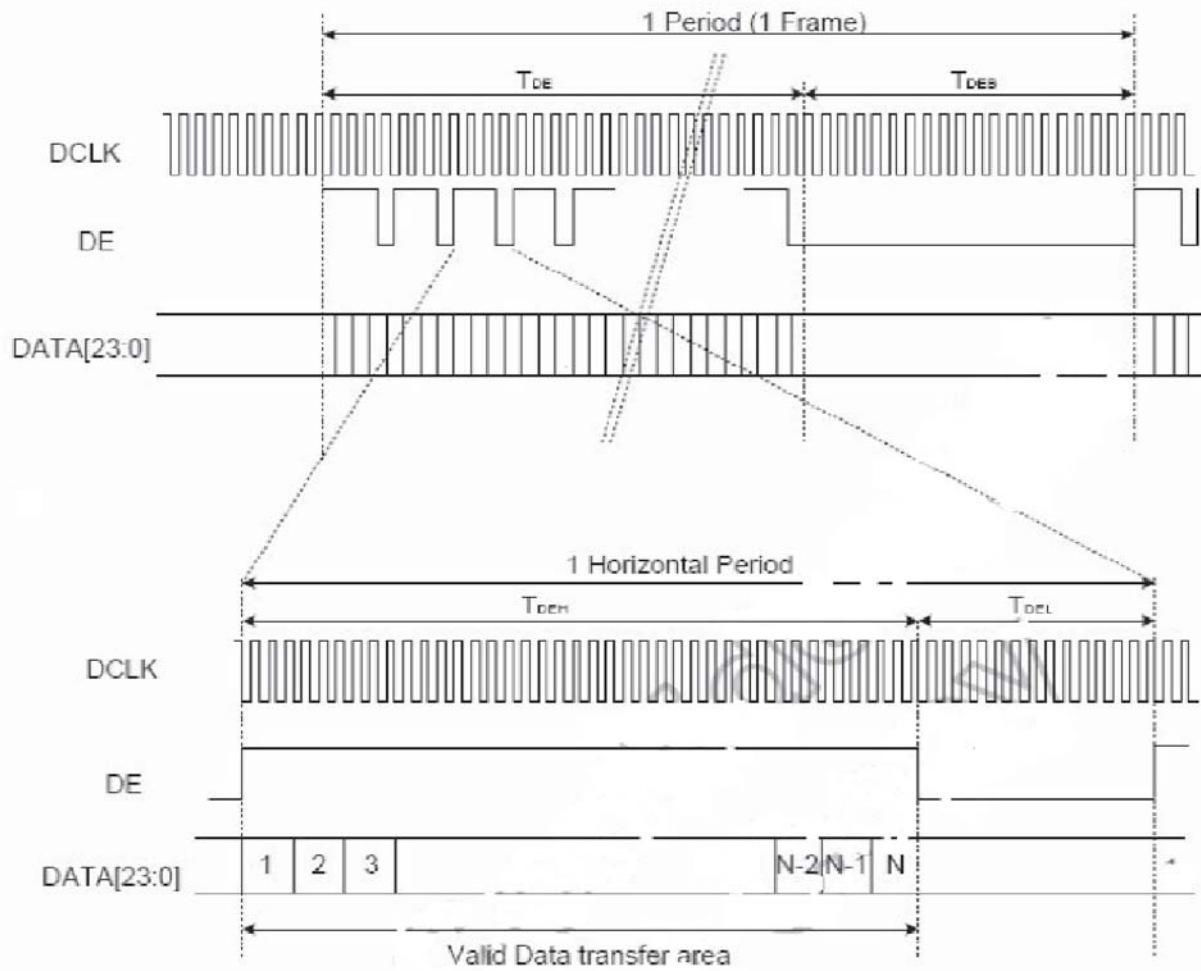

### 6.3 Power ON/OFF Sequence

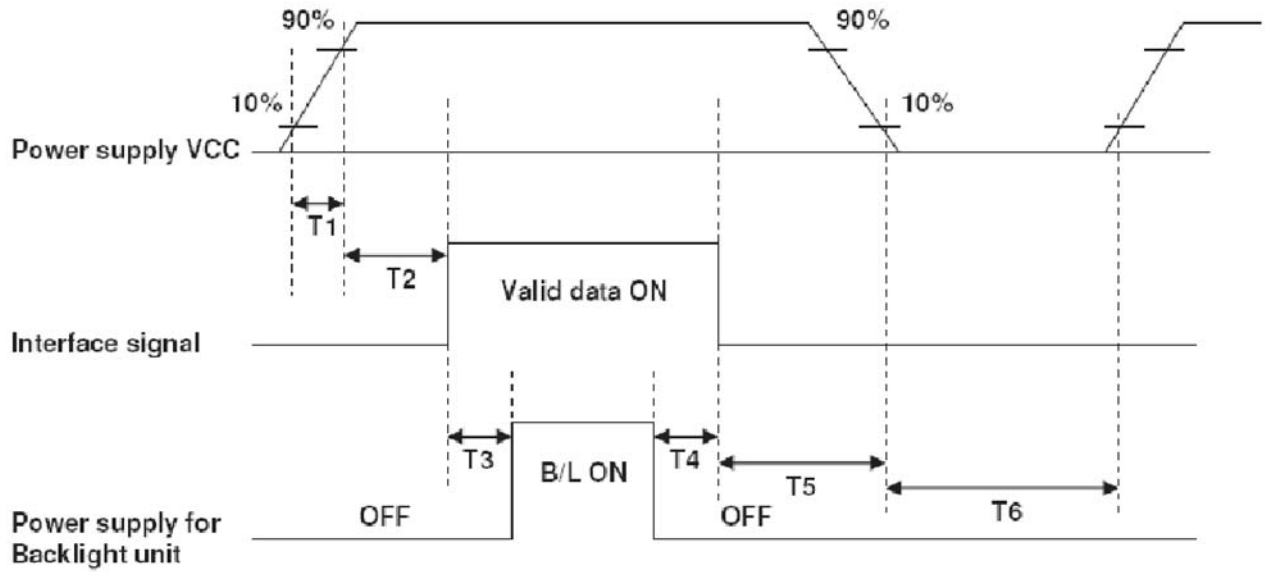

Parameter	SPEC.			Unit
	Min.	Typ.	Max.	
T1	1		2	ms
T2	0	60		ms
T3	200			ms
T4	200			ms
T5	1			ms
T6	1000			ms

## 7. Optical Characteristics

Item	Symbol	Condition	Min	Typ	Max	Unit	Remark	
View Angles	$\theta T$	$CR \geq 10$	50	60		Degree	Note 2	
	$\theta B$		60	70				
	$\theta L$		60	70				
	$\theta R$		60	70				
Contrast Time	CR	$\theta = 0^\circ$	250	400			Note 1 Note 3	
Response Time	$T_{ON}$	$25^\circ C$	-	5	10	ms	Note 1	
	$T_{OFF}$			11	16		Note 4	
Color Filter Chromaticity	White	$\theta = 0^\circ$	x	0.249	0.299	0.349		Note 1
			y	0.278	0.328	0.348		Note 5
Luminance	L	$\theta = 0^\circ$	220	260		cd/m <sup>2</sup>	Note 1 Note 5	

Test Conditions:

- $I_{LED} = 160$  mA(Backlight current),  $VCC = 3.3$  V,the ambient temperature is  $25^\circ C$ .
- The test systems refer to Note 2.

HANTRONIX, INC. 10080 BUBB RD. CUPERTINO, CA 95014	Q.A.:	REV.:	HDA700LT-2S1	SHEET 12 OF 19
	Z.W.	1.0		DATE: 10/15/15

Note 1: Definition of optical measurement system.

The optical characteristics should be measured in dark room. After 5 Minutes operation, the optical properties are measured at the center point of the LCD screen. All input terminals LCD panel must be ground when measuring the center area of the panel.

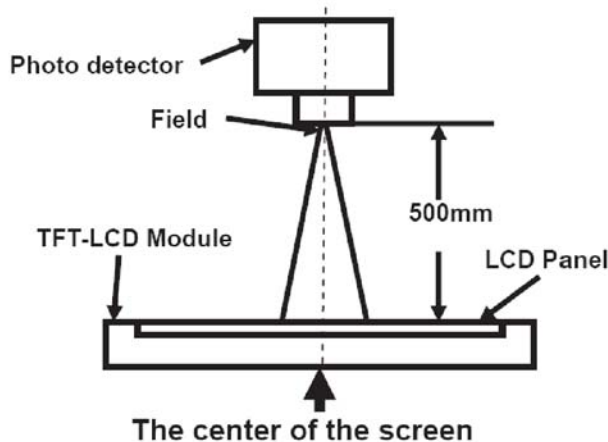

Item	Photo detector	Field
Contrast Ratio	BM-5A	1°
Luminance		
Lum Uniformity		
Chromaticity	SR-3A	
Response Time	TRD100	-

Note 2: Definition of viewing angle range and measurement system.

viewing angle is measured at the center point of the LCD by CONOSCOPE(ergo-80).

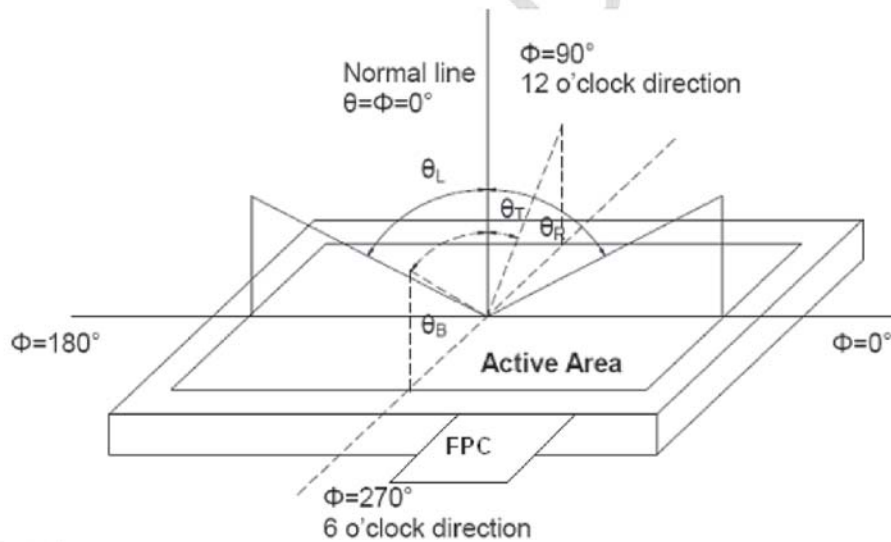

Note 3: Definition of contrast ratio

$$\text{Contrast ratio (CR)} = \frac{\text{Luminance measured when LCD is on the "White" state}}{\text{Luminance measured when LCD is on the "Black" state}}$$

"White state ": The state is that the LCD should drive by  $V_{white}$ .

"Black state ": The state is that the LCD should drive by  $V_{black}$ .

$V_{white}$ : To be determined     $V_{black}$ : To be determined.

Note 4: Definition of Response time

HANTRONIX, INC. 10080 BUBB RD. CUPERTINO, CA 95014	Q.A.:	REV.:	HDA700LT-2S1	SHEET 13 OF 19
	Z.W.	1.0		DATE: 10/15/15

The response time is defined as the LCD optical switching time interval between "White" state and "Black" state. Rise time ( $T_{ON}$ ) is the time between photo detector output intensity changed from 90% to 10%. And fall time ( $T_{OFF}$ ) is the time between photo detector output intensity changed from 10% to 90%.

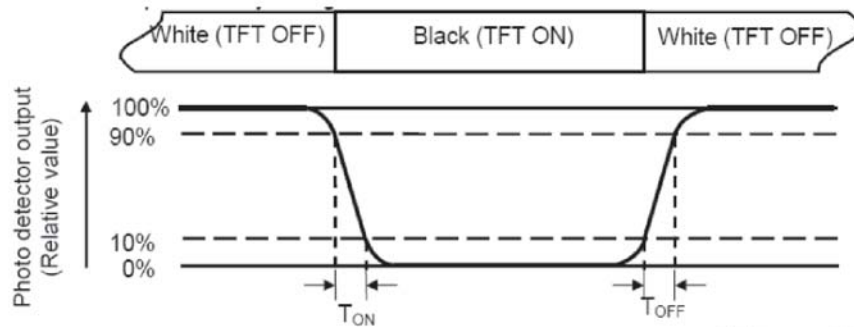

Note 5: Definition of color chromaticity (CIE1931)

Color coordinates measured at center point of LCD.

Note 6: Definition of Luminance Uniformity

Active area is divided into 9 measuring areas (Refer Fig. 2). Every measuring point is placed at the center of each measuring area.

$$\text{Luminance Uniformity (U)} = \text{Lmin} / \text{Lmax}$$

L-----Active area length W----- Active area width

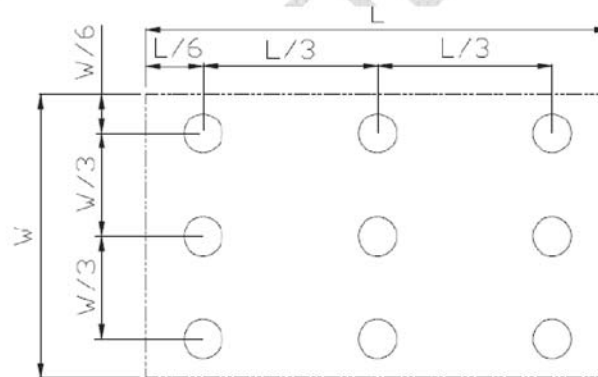

Lmax: The measured Maximum luminance of all measurement position.

Lmin: The measured Minimum luminance of all measurement position.

Note 7: Definition of Luminance:

Measure the luminance of white state at center point.

HANTRONIX, INC. 10080 BUBB RD. CUPERTINO, CA 95014	Q.A.:	REV.:	HDA700LT-2S1	SHEET 14 OF 19
	Z.W.	1.0		DATE: 10/15/15

## 8. Environmental/Reliability Test

No.	Test Item	Test Condition	Inspection after test
1	High Temperature Storage	80±2°C/200 hours	Inspection after 2~4hours storage at room temperature,the sample shall be free from defects: 1.Air bubble in the LCD; 2.Sealleak; 3.Non-display; 4.missing segments; 5.Glass crack; 6.Current Idd is twice higher than initial value.
2	Low Temperature Storage	-30±2°C/200 hours	
3	High Temperature Operating	70±2°C/120 hours	
4	Low Temperature Operating	-20±2°C/120 hours	
5	Temperature Cycle	-25°C~ 25°C~ 70°C × 10cycles (30min.) (5min.) (30min.)	
6	Damp Proof Test	50°C±5°C×90%RH/120 hours	
7	Vibration Test	Frequency: 10Hz~55Hz~10Hz Amplitude: 1.5mm, X, Y, Z direction for total	
8	Dropping test	Drop to the ground from 1m height, one time, every side of carton. (Packing condition)	
9	ESD test	Voltage:±8KVR: 330Ω C: 150pF Air discharge, 10time	

Remark:

- 1.The test samples should be applied to only one test item.
- 2.Sample size for each test item is 5~10pcs.
- 3.For Damp Proof Test, Pure water(Resistance>10MΩ) should be used.
- 4.In case of malfunction defect caused by ESD damage, if it would be recovered to normal state after resetting, it would be judge as a good part.
- 5.EL evaluation should be excepted from reliability test with humidity and temperature: Some defects such as black spot/blemish can happen by natural chemical reaction with humidity and Fluorescence EL has.
- 6.Failure Judgment Criterion: Basic Specification, Electrical Characteristic, Mechanical Characteristic, Optical Characteristic.
- 7.Please use automatic switch menu(or roll menu) testing mode when test operating mode.

HANTRONIX, INC. 10080 BUBB RD. CUPERTINO, CA 95014	Q.A.:	REV.:	<b>HDA700LT-2S1</b>	SHEET 15 OF 19
	Z.W.	1.0		DATE:

## 9. Standard Specifications For Product Quality

### 9.1. Manner of test:

10.1.1 The test must be under 40W fluorescent light, and the distance of view must be at  $30 \pm 10$ cm.

10.1.2 Room temperature  $25 \pm 5^\circ\text{C}$  Humidity:  $(60 \pm 10)\% \text{RH}$ .

### 9.2. Quality specification

It shall be based on GB2828-87, inspection level II .

	IETM	CHECK LEVEL	AQL
MAJOR (MA)	1.Liquid crystal leakage 2.Wrong polarizer 3.Outside dimension 4. Bright dot、Dark dot 5. Display abnormal 6. Class crack	II	0.25
MINOR (MI)	1. Spot Defect (Including black spot、white spot、pinhole、foreign particle、bubbles、hurt) 2. fragment 3. Line Defect (Including black line、white line、cratch) 4. Incision defect 5. Newton's ring 6. Other visual defects	II	1.0

### 9.3. Definition of area:

10.3.1 I area: viewing area

II area: outside viewing area

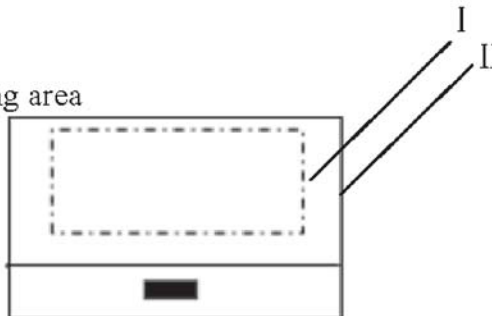

### 9.4. Standard of appearance test for I area: (unit: mm)

NOTE: Defect ignore for II area .

HANTRONIX, INC. 10080 BUBB RD. CUPERTINO, CA 95014	Q.A.:	REV.:	HDA700LT-2S1	SHEET 16 OF 19
	Z.W.	1.0		DATE: 10/15/15

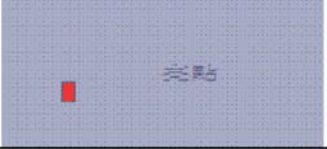
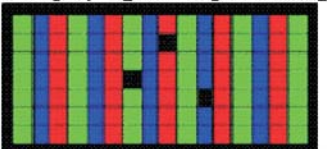

### 9.4.1 Bright/Dark Dots explain

Name	Explain	Definition
Bright dot	Dots appear bright and unchanged in size in which LCD panel is displaying under black pattern 	The definition of dot: The size of a defective dot over 1/2 of single pixel dot is regarded as one defective dot . NOTE: One pixel consists of 3 sub-pixels, including R,G, and B dot. (Sub-pixel = Dot)
Dark dot	Dots appear dark and unchanged in size in which LCD panel is displaying under pure red, green, blue pattern. 	
ADJACENT DOT	Adjacent two sub-pixel are defect (define two dot defect)	

### 9.4.2 Inspection standard

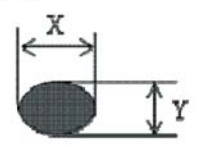
No	Items	Criterion		Checking Manner	Defect Classes
1	Bright/dark dot	Under 6" (contain 6")	Bright dot: no Dark dot: N≤3 <b>Note:</b> be more than 5mm apart	Checking with eyes	MAJ
		6"-12"	Bright dot: N≤4 Dark dot: N≤5 Total Bright and Dark Dots: N≤8 <b>Note :</b> 1. Two bright dot defects (red, green, blue, and white) should be larger than 15mm; 2. The distance between black dot defects or black and bright dot defects should be more than 5mm apart.		
2	Spot Defect (Including black spot.white spot. Pinhole.foreign particle.bubbles.hurt)  $D=(X+Y)/2$	Under 6" (contain 6")	D≤0.1 Ignore 0.1<D≤0.35 N≤3 0.35<D N=0	Checking with eyes	MIN
		6"-12"	D≤0.3 Ignore 0.3<D≤0.6 N≤4 0.6<D N=0		

HANTRONIX, INC.  
10080 BUBB RD.  
CUPERTINO, CA 95014

Q.A.:  
Z.W.

REV.:  
1.0

HDA700LT-2S1

SHEET 17 OF 19

DATE:  
10/15/15

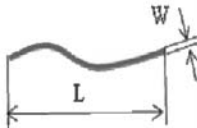
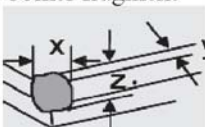
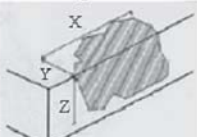
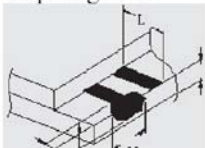
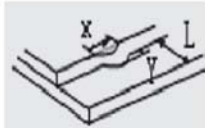
№	Items	Criterion		Checking manner	Defect classes
3	Line Defect (Including black Line.white line. scratch) 	Under 6" (contain 6")	$W \leq 0.02$ Ignore $0.02 < W \leq 0.04$ $L \leq 5$ $N \leq 2$ $0.04 < W \leq 0.06$ $L \leq 5$ $N \leq 1$ $W > 0.06$ $N = 0$	Checking with eyes	MIN
		6"-12"	$W \leq 0.07$ Ignore $0.07 < W \leq 0.1$ $L \leq 10$ $N \leq 4$ $W > 0.1$ $N = 0$		
4	Display abnormal	Not allowed		Checking with eyes	MAJ
5	Outside dimension	Accord with drawing		Callipers	MAJ
6	Class crack	Not allowed		Checking with eyes	MAJ
7	Leak	Not allowed		Checking with eyes	MAJ
8	Comer fragment 	$X \leq 3$ $Y \leq 3$ $Z \leq T$ Ignore Note : 1.No hurt identifying .wire.seal 2.T: Glass thickness X: Length Y: Width Z: thickness		Checking with eyes	MIN
9	Side fragment 	$Y \leq 1$ $Z \leq T$ Ignore Note : 1.No hurt identifying .wire.seal 2.T: Glass thickness X: Length Y: Width Z: thickness		Checking with eyes	MIN
	Step fragment 	$Y \leq 1$ and $Y \leq 1/4 L$		Checking with eyes	MIN
9	Incision defect 	$Y \leq 1$ and accord with outside dimension		Checking with eyes	MIN

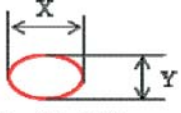
№	Items	Criterion		Checking manner	Defect classes
10	Newton's ring (CTP or Cover board)  $D=(X+Y)/2$	Under 6" (contain 6")	$D \leq 25 \quad N \leq 3$ $D > 25 \quad N = 0$	Checking with eyes	MIN

# Mouser Electronics

Authorized Distributor

Click to View Pricing, Inventory, Delivery & Lifecycle Information:

[Hantronix:](#)

[HDA700LT-2S1](#)