

BCX56-10R1

Preferred Device

NPN Silicon Epitaxial Transistor

These NPN Silicon Epitaxial transistors are designed for use in audio amplifier applications. The device is housed in the SOT-89 package, which is designed for medium power surface mount applications.

- High Current: 1.0 Amp
- Available in 7 inch/1000 unit Tape and Reel
- Device Marking: BK

MAXIMUM RATINGS (T_C = 25°C unless otherwise noted)

Rating	Symbol	Value	Unit
Collector-Emitter Voltage	V _{CEO}	80	Vdc
Collector-Base Voltage	V _{CB0}	100	Vdc
Emitter-Base Voltage	V _{EBO}	5	Vdc
Collector Current	I _C	1	Adc
Total Power Dissipation @ T _A = 25°C Derate above 25°C	P _D (Note 1.)	1.56	Watts
		13	mW/°C
	(Note 2.)	0.67	Watts
		5.0	mW/°C
Operating and Storage Temperature Range	T _J , T _{stg}	-65 to 150	°C

THERMAL CHARACTERISTICS

Characteristic	Symbol	Max	Unit
Thermal Resistance Junction-to-Ambient (surface mounted)	R _{θJA} (Note 1.)	80	°C/W
	(Note 2.)	190	
Maximum Temperature for Soldering Purposes Time in Solder Bath	T _L	260	°C
		10	Sec

1. FR-4 @ 1.0 X 1.0 inch Pad
2. FR-4 @ Minimum Pad



ON Semiconductor™

<http://onsemi.com>

MEDIUM POWER NPN SILICON HIGH CURRENT TRANSISTOR SURFACE MOUNT

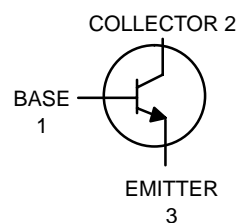

MARKING DIAGRAM

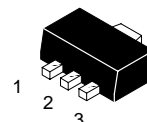

SOT-89
CASE 1213
STYLE 2

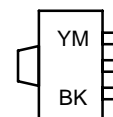

Y = Year Code
M = Month Code
BK = Device Code

ORDERING INFORMATION

Device	Package	Shipping
BCX56-10R1	SOT-89	1000/Tape & Reel

Preferred devices are recommended choices for future use and best overall value.

BCX56-10R1

ELECTRICAL CHARACTERISTICS ($T_A = 25^\circ\text{C}$ unless otherwise noted)

Characteristics	Symbol	Min	Typ	Max	Unit
OFF CHARACTERISTICS					
Collector-Base Breakdown Voltage ($I_C = 100 \mu\text{A}$, $I_E = 0$)	$V_{(BR)CBO}$	100	–	–	Vdc
Collector-Emitter Breakdown Voltage ($I_C = 1.0 \text{mA}$, $I_B = 0$)	$V_{(BR)CEO}$	80	–	–	Vdc
Emitter-Base Breakdown Voltage ($I_E = 10 \mu\text{A}$, $I_C = 0$)	$V_{(BR)EBO}$	5.0	–	–	Vdc
Collector-Base Cutoff Current ($V_{CB} = 30 \text{Vdc}$, $I_E = 0$)	I_{CBO}	–	–	100	nAdc
Emitter-Base Cutoff Current ($V_{EB} = 5.0 \text{Vdc}$, $I_C = 0$)	I_{EBO}	–	–	10	μA dc

ON CHARACTERISTICS (Note 3.)

DC Current Gain ($I_C = 5.0 \text{mA}$, $V_{CE} = 2.0 \text{V}$) ($I_C = 150 \text{mA}$, $V_{CE} = 2.0 \text{V}$) ($I_C = 500 \text{mA}$, $V_{CE} = 2.0 \text{V}$)	h_{FE}	25 63 25	– – –	– 160 –	–
Collector-Emitter Saturation Voltage ($I_C = 500 \text{mA}$, $I_B = 50 \text{mA}$)	$V_{CE(sat)}$	–	–	0.5	Vdc
Base-Emitter On Voltage ($I_C = 500 \text{mA}$, $V_{CE} = 2.0 \text{Vdc}$)	$V_{BE(on)}$	–	–	1.0	Vdc

DYNAMIC CHARACTERISTICS

Current-Gain – Bandwidth Product ($I_C = 10 \text{mA}$, $V_{CE} = 5.0 \text{Vdc}$, $f = 35 \text{MHz}$)	f_T	–	130	–	MHz
--	-------	---	-----	---	-----

3. Pulse Test: Pulse Width $\leq 300 \mu\text{s}$, Duty Cycle $\leq 2.0\%$

TYPICAL ELECTRICAL CHARACTERISTICS

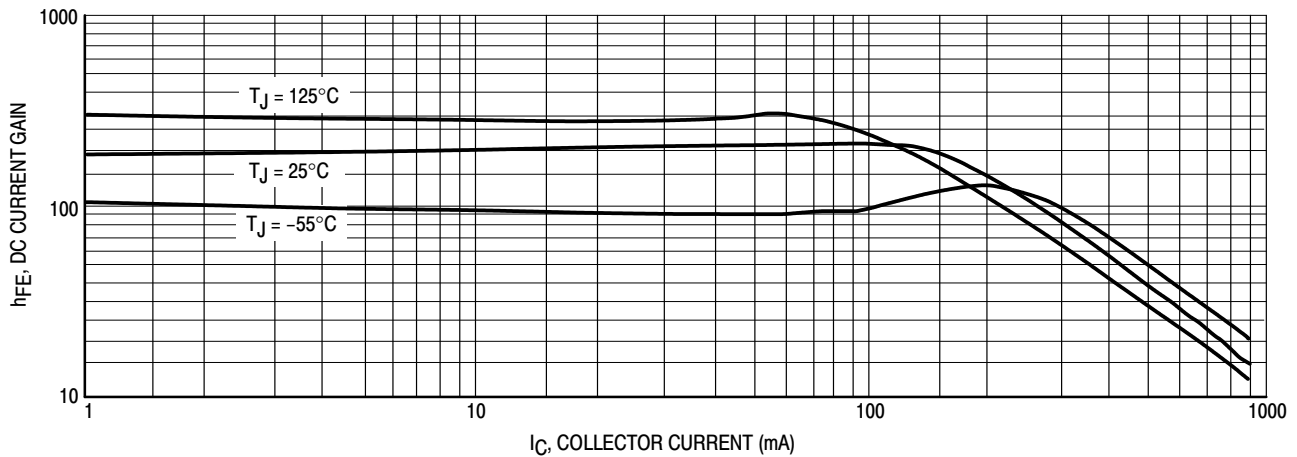

Figure 1. DC Current Gain

TYPICAL ELECTRICAL CHARACTERISTICS

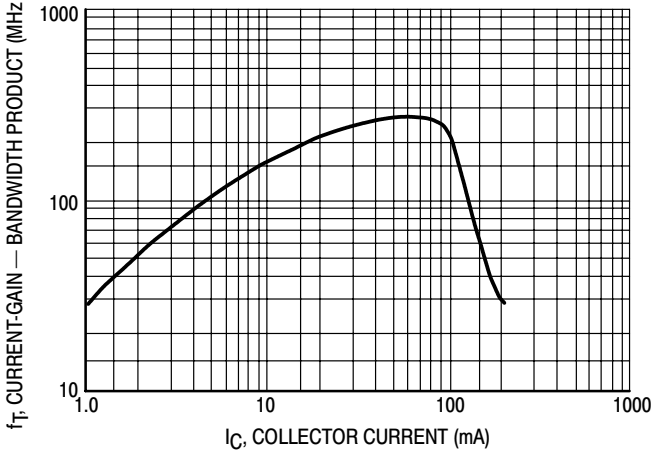

Figure 2. Current-Gain – Bandwidth Product

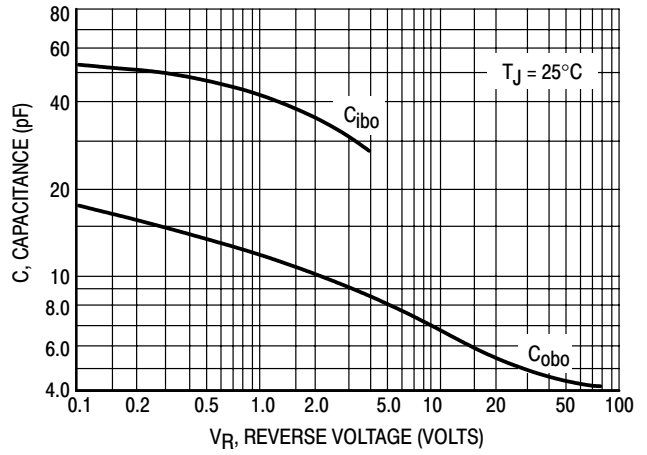

Figure 3. Capacitance

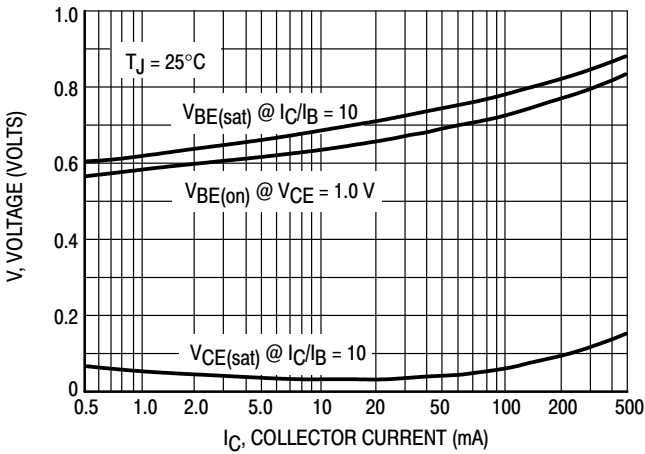

Figure 4. "On" Voltages

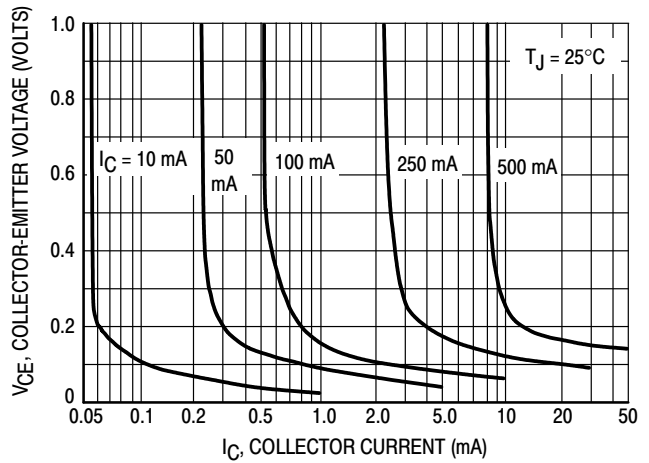

Figure 5. Collector Saturation Region

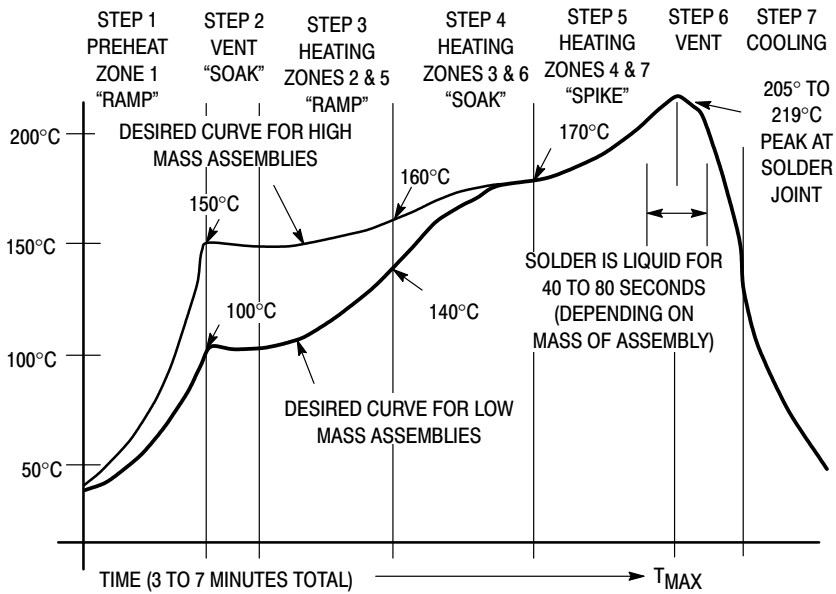
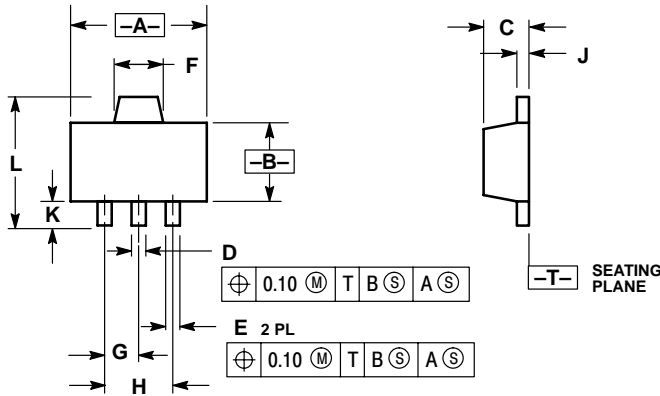

Figure 6. Typical Solder Heating Profile

BCX56-10R1

PACKAGE DIMENSIONS

SOT-89
(3-LEAD)
CASE 1213-02
ISSUE C



NOTES:

1. DIMENSIONING AND TOLERANCING PER ANSI Y14.5M, 1982.
2. CONTROLLING DIMENSION: MILLIMETERS
3. 1213-01 OBSOLETE, NEW STANDARD 1213-02.

DIM	MILLIMETERS		INCHES	
	MIN	MAX	MIN	MAX
A	4.40	4.60	0.173	0.181
B	2.40	2.60	0.094	0.102
C	1.40	1.60	0.055	0.063
D	0.37	0.57	0.015	0.022
E	0.32	0.52	0.013	0.020
F	1.50	1.83	0.059	0.072
G	1.50 BSC		0.059 BSC	
H	3.00 BSC		0.118 BSC	
J	0.30	0.50	0.012	0.020
K	0.80	---	0.031	---
L	---	4.25	---	0.167

STYLE 2:

1. BASE
2. COLLECTOR
3. EMITTER

ON Semiconductor and  are trademarks of Semiconductor Components Industries, LLC (SCILLC). SCILLC reserves the right to make changes without further notice to any products herein. SCILLC makes no warranty, representation or guarantee regarding the suitability of its products for any particular purpose, nor does SCILLC assume any liability arising out of the application or use of any product or circuit, and specifically disclaims any and all liability, including without limitation special, consequential or incidental damages. "Typical" parameters which may be provided in SCILLC data sheets and/or specifications can and do vary in different applications and actual performance may vary over time. All operating parameters, including "Typicals" must be validated for each customer application by customer's technical experts. SCILLC does not convey any license under its patent rights nor the rights of others. SCILLC products are not designed, intended, or authorized for use as components in systems intended for surgical implant into the body, or other applications intended to support or sustain life, or for any other application in which the failure of the SCILLC product could create a situation where personal injury or death may occur. Should Buyer purchase or use SCILLC products for any such unintended or unauthorized application, Buyer shall indemnify and hold SCILLC and its officers, employees, subsidiaries, affiliates, and distributors harmless against all claims, costs, damages, and expenses, and reasonable attorney fees arising out of, directly or indirectly, any claim of personal injury or death associated with such unintended or unauthorized use, even if such claim alleges that SCILLC was negligent regarding the design or manufacture of the part. SCILLC is an Equal Opportunity/Affirmative Action Employer.

PUBLICATION ORDERING INFORMATION

Literature Fulfillment:

Literature Distribution Center for ON Semiconductor
P.O. Box 5163, Denver, Colorado 80217 USA
Phone: 303-675-2175 or 800-344-3860 Toll Free USA/Canada
Fax: 303-675-2176 or 800-344-3867 Toll Free USA/Canada
Email: ONlit@hibbertco.com

N. American Technical Support: 800-282-9855 Toll Free USA/Canada

JAPAN: ON Semiconductor, Japan Customer Focus Center
4-32-1 Nishi-Gotanda, Shinagawa-ku, Tokyo, Japan 141-0031
Phone: 81-3-5740-2700
Email: r14525@onsemi.com

ON Semiconductor Website: <http://onsemi.com>

For additional information, please contact your local Sales Representative.