

SNx4HC14 Hex Schmitt-Trigger Inverters

1 Features

- Wide Operating Voltage Range of 2 V to 6 V
- Outputs Can Drive Up to 10 LSTTL Loads
- Low Power Consumption, 20- μ A Max I_{CC}
- Typical $t_{pd} = 11$ ns
- ± 4 -mA Output Drive at 5 V
- Low Input Current of 1 μ A Max
- On Products Compliant to MIL-PRF-38535, All Parameters Are Tested Unless Otherwise Noted. On All Other Products, Production Processing Does Not Necessarily Include Testing of All Parameters.

2 Applications

- Microwave Oven
- Mice
- Printers
- AC Inverter Drives
- UPS
- AC Servo Drives
- Other Motor Drives

3 Description

These Schmitt-trigger devices contain six independent inverters. They perform the Boolean function $Y = \overline{A}$ in positive logic.

Device Information⁽¹⁾

| PART NUMBER | PACKAGE | BODY SIZE (NOM) |
|-------------|------------|-----------------------|
| SNx4HC14 | CDIP (14) | 7.62 mm x 19.94 mm |
| | CFP (14) | 7.11 mm x 9.11 mm |
| | LCCC (20) | 8.89 mm x 8.89 mm |
| | SOIC (14) | 6.00 mm x 8.65 mm |
| | SSOP (14) | 367.00 mm x 367.00 mm |
| | PDIP (14) | 7.94 mm x 10.35 mm |
| | SO (14) | 7.80 mm x 10.20 mm |
| | TSSOP (14) | 6.40 mm x 5.00 mm |

(1) For all available packages, see the orderable addendum at the end of the data sheet.

Logic Diagram (Positive Logic)

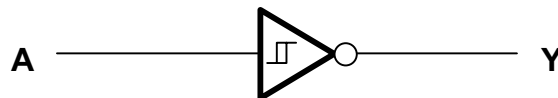

Table of Contents

| | |
|--|--|
| 1 Features 1 2 Applications 1 3 Description 1 4 Revision History 2 5 Device Comparison Table 3 6 Pin Configuration and Functions 4 7 Specifications 5 7.1 Absolute Maximum Ratings 5 7.2 ESD Ratings 5 7.3 Recommended Operating Conditions 5 7.4 Thermal Information 5 7.5 Electrical Characteristics 6 7.6 Switching Characteristics 6 7.7 Operating Characteristics 6 7.8 Typical Characteristics 7 8 Parameter Measurement Information 8 9 Detailed Description 9 9.1 Overview 9 | 9.2 Functional Block Diagram 9 9.3 Feature Description 9 9.4 Device Functional Modes 9 10 Application and Implementation 10 10.1 Application Information 10 10.2 Typical Application 10 11 Power Supply Recommendations 11 12 Layout 12 12.1 Layout Guidelines 12 12.2 Layout Example 12 13 Device and Documentation Support 13 13.1 Documentation Support 13 13.2 Related Links 13 13.3 Community Resources 13 13.4 Trademarks 13 13.5 Electrostatic Discharge Caution 13 13.6 Glossary 13 14 Mechanical, Packaging, and Orderable Information 13 |
|--|--|

4 Revision History

NOTE: Page numbers for previous revisions may differ from page numbers in the current version.

| Changes from Revision G (January 2014) to Revision H | Page |
|--|------|
| • Added <i>Pin Configuration and Functions</i> section, <i>ESD Ratings</i> table, <i>Feature Description</i> section, <i>Device Functional Modes</i> , <i>Application and Implementation</i> section, <i>Power Supply Recommendations</i> section, <i>Layout</i> section, <i>Device and Documentation Support</i> section, and <i>Mechanical, Packaging, and Orderable Information</i> section | 1 |
| • Added Military Disclaimer to <i>Features</i> list. | 1 |
| • Added <i>Applications</i> . | 1 |

| Changes from Revision F (December 2010) to Revision G | Page |
|--|------|
| • Updated document to new TI data sheet format - no specification changes. | 1 |

5 Device Comparison Table

| PART NUMBER | PACKAGE | BODY SIZE (NOM) |
|-------------|------------|-----------------------|
| SN54HC14J | CDIP (14) | 7.62 mm x 19.94 mm |
| SNJ54HC14W | CFP (14) | 7.11 mm x 9.11 mm |
| SNJ54HC14FK | LCCC (20) | 8.89 mm x 8.89 mm |
| SN74HC14DR | SOIC (14) | 6.00 mm x 8.65 mm |
| SN74HC14DBR | SSOP (14) | 367.00 mm x 367.00 mm |
| SN74HC14N | PDIP (14) | 7.94 mm x 10.35 mm |
| SN74HC14NSR | SO (14) | 7.80 mm x 10.20 mm |
| SN74HC14PW | TSSOP (14) | 6.40 mm x 5.00 mm |

6 Pin Configuration and Functions

J, W, D, DB, N, NS, or PW Package
14-Pin CDIP, CFP, SOIC, SSOP, SO, or TSSOP
Top View

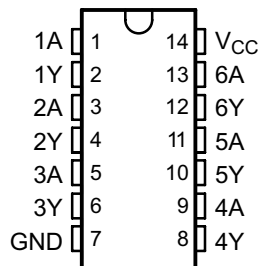

FK Package
20-Pin LCCC
Top View

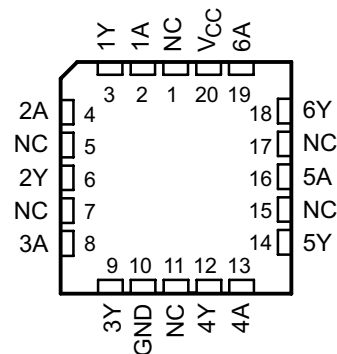

Pin Functions

| PIN | | | I/O | DESCRIPTION |
|-------------------|--|------|-----|------------------------|
| NAME | CDIP, CFP, SOIC, SSOP, SO, TSSOP | LCCC | | |
| 1A | 1 | 2 | I | Channel 1 input |
| 1Y | 2 | 3 | O | Channel 1 output |
| 2A | 3 | 4 | I | Channel 2 input |
| 2Y | 4 | 6 | O | Channel 2 output |
| 3A | 5 | 8 | I | Channel 3 input |
| 3Y | 6 | 9 | O | Channel 3 output |
| GND | 7 | 10 | — | Ground |
| 4Y | 8 | 12 | O | Channel 4 output |
| 4A | 9 | 13 | I | Channel 4 input |
| 5Y | 10 | 14 | O | Channel 5 output |
| 5A | 11 | 16 | I | Channel 5 input |
| 6Y | 12 | 18 | O | Channel 6 output |
| 6A | 13 | 19 | I | Channel 6 input |
| V _{CC} | 14 | 20 | — | Power supply |
| NC ⁽¹⁾ | — | 1 | — | No internal connection |
| | | 5 | | |
| | | 7 | | |
| | | 11 | | |
| | | 15 | | |
| | | 17 | | |

(1) NC – No internal connection

7 Specifications

7.1 Absolute Maximum Ratings

over operating free-air temperature range (unless otherwise noted)⁽¹⁾

| | | MIN | MAX | UNIT |
|------------------|---|--|-----|-----------|
| V _{CC} | Supply voltage | -0.5 | 7 | V |
| I _{IK} | Input clamp current ⁽²⁾ | V _I < 0 or V _I > V _{CC} | | ±20 mA |
| I _{OK} | Output clamp current ⁽²⁾ | V _O < 0 | | ±20 mA |
| I _O | Continuous output current | V _O = 0 to V _{CC} | | ±25 mA |
| | Continuous current through V _{CC} or GND | | | ±50 mA |
| T _j | Junction temperature | | | 150 °C |
| T _{stg} | Storage temperature | -65 | 150 | |

- (1) Stresses beyond those listed under *Absolute Maximum Ratings* may cause permanent damage to the device. These are stress ratings only, and functional operation of the device at these or any other conditions beyond those indicated under *Recommended Operating Conditions* is not implied. Exposure to absolute-maximum-rated conditions for extended periods may affect device reliability.
- (2) The input and output voltage ratings may be exceeded if the input and output current ratings are observed.

7.2 ESD Ratings

| | | VALUE | UNIT |
|--------------------|-------------------------|--|-------|
| V _(ESD) | Electrostatic discharge | Human body model (HBM), per ANSI/ESDA/JEDEC JS-001 ⁽¹⁾ | ±2000 |
| | | Charged-device model (CDM), per JEDEC specification JESD22-C101 ⁽²⁾ | ±1500 |

- (1) JEDEC document JEP155 states that 500-V HBM allows safe manufacturing with a standard ESD control process.
- (2) JEDEC document JEP157 states that 250-V CDM allows safe manufacturing with a standard ESD control process.

7.3 Recommended Operating Conditions

See ⁽¹⁾.

| | | SN54HC14 | | | SN74HC14 | | | UNIT |
|-----------------|--------------------------------|----------|-----|-----------------|----------|-----|-----------------|------|
| | | MIN | NOM | MAX | MIN | NOM | MAX | |
| V _{CC} | Supply voltage | 2 | 5 | 6 | 2 | 5 | 6 | V |
| V _I | Input voltage | 0 | | V _{CC} | 0 | | V _{CC} | V |
| V _O | Output voltage | 0 | | V _{CC} | 0 | | V _{CC} | V |
| T _A | Operating free-air temperature | -55 | | 125 | -40 | | 85 | °C |

- (1) All unused inputs of the device must be held at V_{CC} or GND to ensure proper device operation. Refer to the TI application report, *Implications of Slow or Floating CMOS Inputs*, [SCBA004](#).

7.4 Thermal Information

| THERMAL METRIC ⁽¹⁾ | SNx4HC14 | | | | | UNIT | |
|-------------------------------|--|-----------|----------|---------|------------|------|------|
| | D (SOIC) | DB (SSOP) | N (PDIP) | NS (SO) | PW (TSSOP) | | |
| | 14 PINS | 14 PINS | 14 PINS | 14 PINS | 14 PINS | | |
| R _{θJA} | Junction-to-ambient thermal resistance | 86 | 96 | 80 | 76 | 113 | °C/W |

- (1) For more information about traditional and new thermal metrics, see the *Semiconductor and IC Package Thermal Metrics* application report, [SPRA953](#).

SN54HC14, SN74HC14

SCLS085H – DECEMBER 1982 – REVISED SEPTEMBER 2015

www.ti.com

7.5 Electrical Characteristics

over operating free-air temperature range (unless otherwise noted)

| PARAMETER | TEST CONDITIONS | | V _{CC} | T _A = 25°C | | | SN54HC14 | | SN74HC14 | | UNIT |
|-----------------------------------|---|---------------------------|-----------------|-----------------------|-------|------|----------|-------|----------|-------|------|
| | | | | MIN | TYP | MAX | MIN | MAX | MIN | MAX | |
| V _{T+} | | | 2 V | 0.7 | 1.2 | 1.5 | 0.7 | 1.5 | 0.7 | 1.5 | V |
| | | | 4.5 V | 1.55 | 2.5 | 3.15 | 1.55 | 3.15 | 1.55 | 3.15 | |
| | | | 6 V | 2.1 | 3.3 | 4.2 | 2.1 | 4.2 | 2.1 | 4.2 | |
| V _{T-} | | | 2 V | 0.3 | 0.6 | 1 | 0.3 | 1 | 0.3 | 1 | V |
| | | | 4.5 V | 0.9 | 1.6 | 2.45 | 0.9 | 2.45 | 0.9 | 2.45 | |
| | | | 6 V | 1.2 | 2 | 3.2 | 1.2 | 3.2 | 1.2 | 3.2 | |
| V _{T+} - V _{T-} | | | 2 V | 0.2 | 0.6 | 1.2 | 0.2 | 1.2 | 0.2 | 1.2 | V |
| | | | 4.5 V | 0.4 | 0.9 | 2.1 | 0.4 | 2.1 | 0.4 | 2.1 | |
| | | | 6 V | 0.5 | 1.3 | 2.5 | 0.5 | 2.5 | 0.5 | 2.5 | |
| V _{OH} | V _I = V _{IH} or V _{IL} | I _{OH} = -20 μA | 2 V | 1.9 | 1.998 | | 1.9 | | 1.9 | V | |
| | | | 4.5 V | 4.4 | 4.499 | | 4.4 | | 4.4 | | |
| | | | 6 V | 5.9 | 5.999 | | 5.9 | | 5.9 | | |
| | | I _{OH} = -4 mA | 4.5 V | 3.98 | 4.3 | | 3.7 | | 3.84 | | |
| | | I _{OH} = -5.2 mA | 6 V | 5.48 | 5.8 | | 5.2 | | 5.34 | | |
| V _{OL} | V _I = V _{IH} or V _{IL} | I _{OL} = 20 μA | 2 V | | 0.002 | 0.1 | | 0.1 | | 0.1 | V |
| | | | 4.5 V | | 0.001 | 0.1 | | 0.1 | | 0.1 | |
| | | | 6 V | | 0.001 | 0.1 | | 0.1 | | 0.1 | |
| | | I _{OL} = 4 mA | 4.5 V | | 0.17 | 0.26 | | 0.4 | | 0.33 | |
| | | I _{OL} = 5.2 mA | 6 V | | 0.15 | 0.26 | | 0.4 | | 0.33 | |
| I _I | V _I = V _{CC} or 0 | | 6 V | | ±0.1 | ±100 | | ±1000 | | ±1000 | nA |
| I _{CC} | V _I = V _{CC} or 0, I _O = 0 | | 6 V | | | | | 2 | 40 | 20 | μA |
| C _i | | | 2 V to 6 V | | | 3 | 10 | | 10 | 10 | pF |

7.6 Switching Characteristics

over operating free-air temperature range, C_L = 50 pF (unless otherwise noted) (see Figure 3)

| PARAMETER | FROM (INPUT) | TO (OUTPUT) | V _{CC} | T _A = 25°C | | | SN54HC08 | | SN74HC08 | | UNIT |
|-----------------|--------------|-------------|-----------------|-----------------------|-----|-----|----------|-----|----------|-----|------|
| | | | | MIN | TYP | MAX | MIN | MAX | MIN | MAX | |
| t _{pd} | A | Y | 2 V | | 55 | 125 | | 190 | | 155 | ns |
| | | | 4.5 V | | 12 | 25 | | 38 | | 31 | |
| | | | 6 V | | 11 | 21 | | 22 | | 26 | |
| t _t | | Y | 2 V | | 38 | 75 | | 110 | | 95 | ns |
| | | | 4.5 V | | 8 | 15 | | 22 | | 19 | |
| | | | 6 V | | 6 | 13 | | 19 | | 16 | |

7.7 Operating Characteristics

T_A = 25°C

| PARAMETER | TEST CONDITIONS | TYP | UNIT |
|-----------------|---|-----|------|
| C _{pd} | Power dissipation capacitance per inverter No load | 20 | pF |

7.8 Typical Characteristics

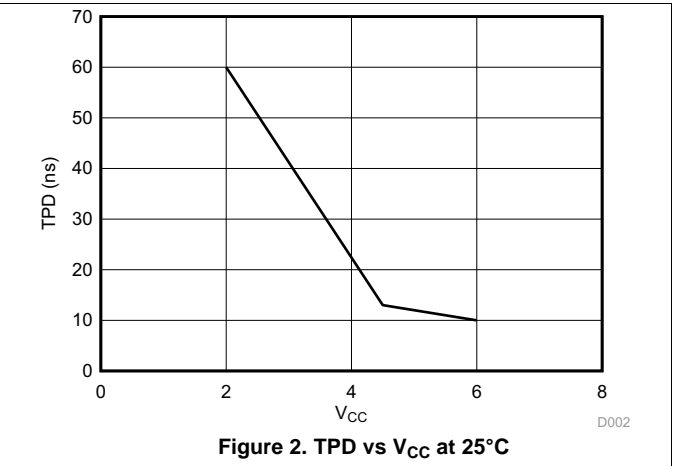
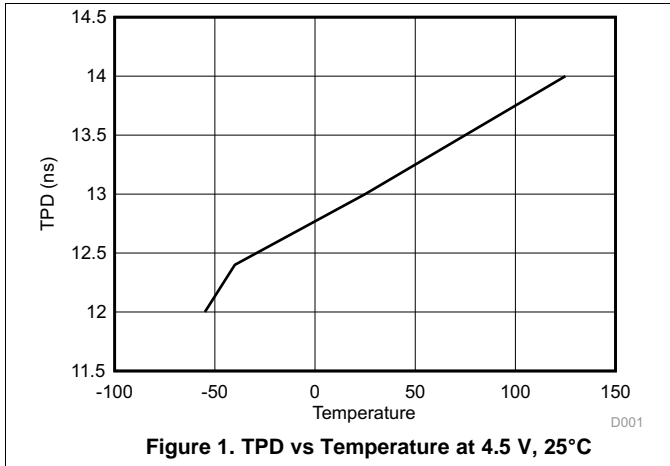

8 Parameter Measurement Information

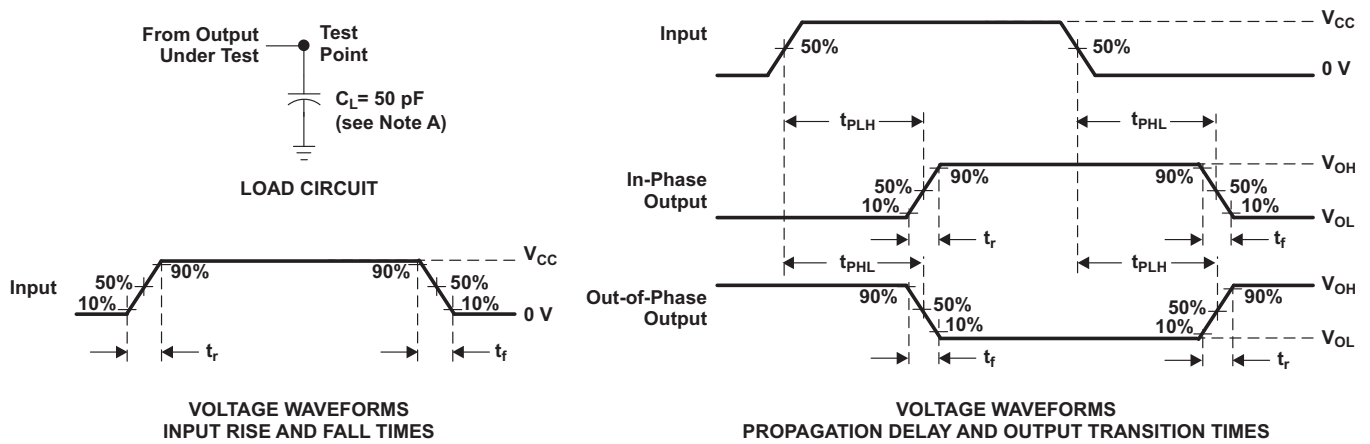

Figure 3. Load Circuit and Voltage Waveforms

9 Detailed Description

9.1 Overview

These Schmitt-trigger devices contain six independent inverters. They perform the Boolean function $Y = \overline{A}$ in positive logic.

Schmitt-trigger inputs are designed to provide a minimum separation between positive and negative switching thresholds. This allows for noisy or slow inputs that would cause problems such as oscillation or excessive current draw with normal CMOS inputs.

9.2 Functional Block Diagram

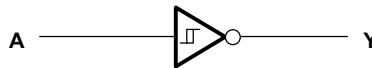

Figure 4. Logic Diagram (Positive Logic)

9.3 Feature Description

The wide operating range of the device allows it to be used in a variety of systems that use different logic levels. The outputs can drive up to 10 LSTTL loads each. The device has very low power consumption, with 20- μ A Max I_{CC} . Typical propagation delay is also low at 11 ns. The balanced drive outputs can source or sink 4 mA at 5-V V_{CC} . The input leakage current is 1 μ A Max.

9.4 Device Functional Modes

Table 1 lists the functional modes of the SNx4HC14.

Table 1. Function Table (Each Inverter)

| INPUTS A | OUTPUT Y |
|-------------|-------------|
| H | L |
| L | H |

10 Application and Implementation

NOTE

Information in the following applications sections is not part of the TI component specification, and TI does not warrant its accuracy or completeness. TI's customers are responsible for determining suitability of components for their purposes. Customers should validate and test their design implementation to confirm system functionality.

10.1 Application Information

The SNx4HC14 device is a Schmitt-trigger input CMOS device that can be used for a multitude of inverting buffer type functions. The application shown here takes advantage of the Schmitt-trigger inputs to produce a delay for a logic output.

10.2 Typical Application

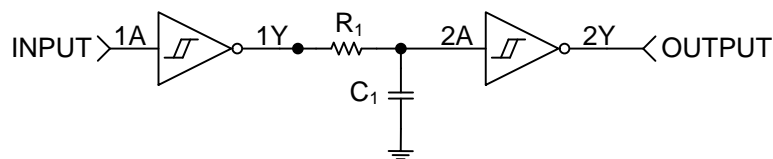

Figure 5. Simplified Application Schematic

10.2.1 Design Requirements

This device uses CMOS technology. Take care to avoid bus contention because it can drive currents that would exceed maximum limits. Parallel output drive can create fast edges into light loads so consider routing and load conditions to prevent ringing.

10.2.2 Detailed Design Procedure

This circuit is designed around an RC network that produces a slow input to the second inverter. The RC time constant, τ , is calculated from: $\tau = R \times C$

The delay time for this circuit will be between 1.2τ and 0.42τ . It should be noted that the delay will be consistent for each device, but since the switching threshold is only guaranteed between a minimum and maximum value, the output pulse length will vary between devices. These values were calculated by using the minimum and maximum guaranteed V_{T+} values.

The resistor value should be chosen such that the maximum current from/to the SNx4HC14 is 4 mA.

- Recommended input conditions:
 - Schmitt-trigger inputs allow for slow inputs.
 - Specified high and low levels. See (V_{IH} and V_{IL}) in [Recommended Operating Conditions](#).
- Recommended output conditions:
 - Load currents should not exceed 4 mA per output.

Typical Application (continued)

10.2.3 Application Curve

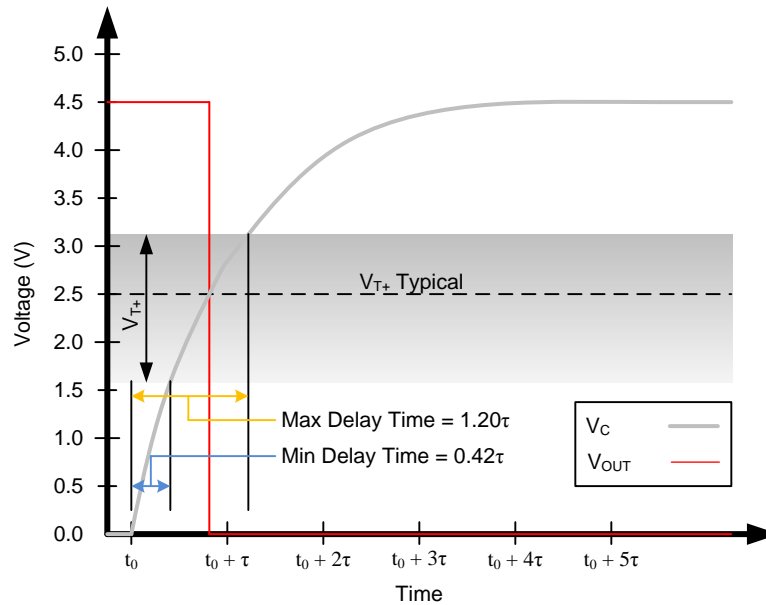

Figure 6. Ideal Capacitor Voltage and Output Voltage With Positive Switching Threshold Range Representation.

11 Power Supply Recommendations

The power supply can be any voltage between the minimum and maximum supply voltage rating located in the [Recommended Operating Conditions](#). Each V_{CC} terminal should have a good bypass capacitor to prevent power disturbance. For devices with a single supply, TI recommends a 0.1- μF capacitor. If there are multiple V_{CC} terminals, then TI recommends a 0.01- μF or 0.022- μF capacitor for each power terminal. Multiple bypass capacitors can be paralleled to reject different frequencies of noise. Frequencies of 0.1 μF and 1 μF are commonly used in parallel. The bypass capacitor should be installed as close as possible to the power terminal for best results.

12 Layout

12.1 Layout Guidelines

When using multiple bit logic devices, inputs should never float. In many cases, functions or parts of functions of digital logic devices are unused, for example, when only two inputs of a triple-input AND gate are used or only three of the four buffer gates are used. Such input pins should not be left unconnected because the undefined voltages at the outside connections result in undefined operational states. All unused inputs of digital logic devices must be connected to a high or low bias to prevent them from floating. The logic level that should be applied to any particular unused input depends on the function of the device. Generally they will be tied to GND or V_{CC} whichever makes more sense or is more convenient. Floating outputs is generally acceptable, unless the part is a transceiver.

12.2 Layout Example

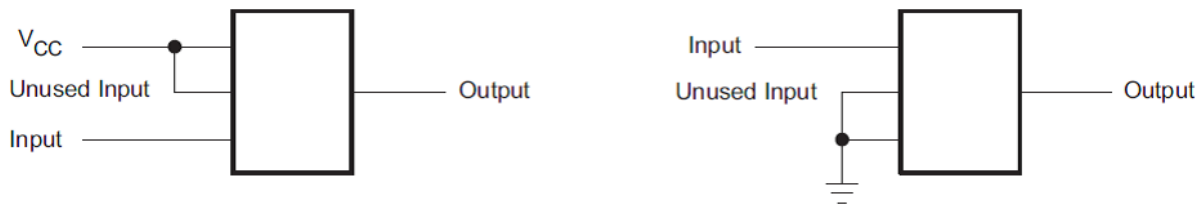

Figure 7. Layout Recommendation

13 Device and Documentation Support

13.1 Documentation Support

13.1.1 Related Documentation

For related documentation, please see the following:

Implications of Slow or Floating CMOS Inputs, [SCBA004](#)

13.2 Related Links

The table below lists quick access links. Categories include technical documents, support and community resources, tools and software, and quick access to sample or buy.

Table 2. Related Links

| PARTS | PRODUCT FOLDER | SAMPLE & BUY | TECHNICAL DOCUMENTS | TOOLS & SOFTWARE | SUPPORT & COMMUNITY |
|----------|----------------------------|----------------------------|----------------------------|----------------------------|----------------------------|
| SN54HC05 | Click here | Click here | Click here | Click here | Click here |
| SN74HC05 | Click here | Click here | Click here | Click here | Click here |

13.3 Community Resources

The following links connect to TI community resources. Linked contents are provided "AS IS" by the respective contributors. They do not constitute TI specifications and do not necessarily reflect TI's views; see TI's [Terms of Use](#).

TI E2E™ Online Community *TI's Engineer-to-Engineer (E2E) Community*. Created to foster collaboration among engineers. At e2e.ti.com, you can ask questions, share knowledge, explore ideas and help solve problems with fellow engineers.

Design Support *TI's Design Support* Quickly find helpful E2E forums along with design support tools and contact information for technical support.

13.4 Trademarks

E2E is a trademark of Texas Instruments.

All other trademarks are the property of their respective owners.

13.5 Electrostatic Discharge Caution



These devices have limited built-in ESD protection. The leads should be shorted together or the device placed in conductive foam during storage or handling to prevent electrostatic damage to the MOS gates.

13.6 Glossary

[SLYZ022](#) — *TI Glossary*.

This glossary lists and explains terms, acronyms, and definitions.

14 Mechanical, Packaging, and Orderable Information

The following pages include mechanical, packaging, and orderable information. This information is the most current data available for the designated devices. This data is subject to change without notice and revision of this document. For browser-based versions of this data sheet, refer to the left-hand navigation.

PACKAGING INFORMATION

| Orderable Device | Status (1) | Package Type | Package Drawing | Pins | Package Qty | Eco Plan (2) | Lead/Ball Finish (6) | MSL Peak Temp (3) | Op Temp (°C) | Device Marking (4/5) | Samples |
|------------------|---------------|--------------|--------------------|------|----------------|----------------------------|-------------------------|----------------------|--------------|-----------------------------------|-------------------------|
| 5962-8409101VCA | ACTIVE | CDIP | J | 14 | 1 | TBD | A42 | N / A for Pkg Type | -55 to 125 | 5962-8409101VC A SNV54HC14J | Samples |
| 5962-8409101VDA | ACTIVE | CFP | W | 14 | 1 | TBD | A42 | N / A for Pkg Type | -55 to 125 | 5962-8409101VD A SNV54HC14W | Samples |
| 84091012A | ACTIVE | LCCC | FK | 20 | 1 | TBD | POST-PLATE | N / A for Pkg Type | -55 to 125 | 84091012A SNJ54HC 14FK | Samples |
| 8409101CA | ACTIVE | CDIP | J | 14 | 1 | TBD | A42 | N / A for Pkg Type | -55 to 125 | 8409101CA SNJ54HC14J | Samples |
| 8409101DA | ACTIVE | CFP | W | 14 | 1 | TBD | A42 | N / A for Pkg Type | -55 to 125 | 8409101DA SNJ54HC14W | Samples |
| JM38510/65702BCA | ACTIVE | CDIP | J | 14 | 1 | TBD | A42 | N / A for Pkg Type | -55 to 125 | JM38510/ 65702BCA | Samples |
| JM38510/65702BDA | ACTIVE | CFP | W | 14 | 1 | TBD | A42 | N / A for Pkg Type | -55 to 125 | JM38510/ 65702BDA | Samples |
| M38510/65702BCA | ACTIVE | CDIP | J | 14 | 1 | TBD | A42 | N / A for Pkg Type | -55 to 125 | JM38510/ 65702BCA | Samples |
| M38510/65702BDA | ACTIVE | CFP | W | 14 | 1 | TBD | A42 | N / A for Pkg Type | -55 to 125 | JM38510/ 65702BDA | Samples |
| SN54HC14J | ACTIVE | CDIP | J | 14 | 1 | TBD | A42 | N / A for Pkg Type | -55 to 125 | SN54HC14J | Samples |
| SN74HC14D | ACTIVE | SOIC | D | 14 | 50 | Green (RoHS & no Sb/Br) | CU NIPDAU | Level-1-260C-UNLIM | -40 to 85 | HC14 | Samples |
| SN74HC14DBR | ACTIVE | SSOP | DB | 14 | 2000 | Green (RoHS & no Sb/Br) | CU NIPDAU | Level-1-260C-UNLIM | -40 to 85 | HC14 | Samples |
| SN74HC14DBRG4 | ACTIVE | SSOP | DB | 14 | 2000 | Green (RoHS & no Sb/Br) | CU NIPDAU | Level-1-260C-UNLIM | -40 to 85 | HC14 | Samples |
| SN74HC14DE4 | ACTIVE | SOIC | D | 14 | 50 | Green (RoHS & no Sb/Br) | CU NIPDAU | Level-1-260C-UNLIM | -40 to 85 | HC14 | Samples |
| SN74HC14DG4 | ACTIVE | SOIC | D | 14 | 50 | Green (RoHS & no Sb/Br) | CU NIPDAU | Level-1-260C-UNLIM | -40 to 85 | HC14 | Samples |
| SN74HC14DR | ACTIVE | SOIC | D | 14 | 2500 | Green (RoHS & no Sb/Br) | CU NIPDAU CU SN | Level-1-260C-UNLIM | -40 to 85 | HC14 | Samples |

| Orderable Device | Status (1) | Package Type | Package Drawing | Pins | Package Qty | Eco Plan (2) | Lead/Ball Finish (6) | MSL Peak Temp (3) | Op Temp (°C) | Device Marking (4/5) | Samples |
|------------------|---------------|--------------|-----------------|------|-------------|-------------------------|-------------------------|----------------------|--------------|-------------------------|-------------------------|
| SN74HC14DRE4 | ACTIVE | SOIC | D | 14 | 2500 | Green (RoHS & no Sb/Br) | CU NIPDAU | Level-1-260C-UNLIM | -40 to 85 | HC14 | Samples |
| SN74HC14DRG3 | ACTIVE | SOIC | D | 14 | 2500 | Green (RoHS & no Sb/Br) | CU SN | Level-1-260C-UNLIM | -40 to 85 | HC14 | Samples |
| SN74HC14DRG4 | ACTIVE | SOIC | D | 14 | 2500 | Green (RoHS & no Sb/Br) | CU NIPDAU | Level-1-260C-UNLIM | -40 to 85 | HC14 | Samples |
| SN74HC14DT | ACTIVE | SOIC | D | 14 | 250 | Green (RoHS & no Sb/Br) | CU NIPDAU | Level-1-260C-UNLIM | -40 to 85 | HC14 | Samples |
| SN74HC14DTG4 | ACTIVE | SOIC | D | 14 | 250 | Green (RoHS & no Sb/Br) | CU NIPDAU | Level-1-260C-UNLIM | -40 to 85 | HC14 | Samples |
| SN74HC14N | ACTIVE | PDIP | N | 14 | 25 | Pb-Free (RoHS) | CU NIPDAU CU SN | N / A for Pkg Type | -40 to 85 | SN74HC14N | Samples |
| SN74HC14N3 | OBSOLETE | PDIP | N | 14 | | TBD | Call TI | Call TI | -40 to 85 | | |
| SN74HC14NE4 | ACTIVE | PDIP | N | 14 | 25 | Pb-Free (RoHS) | CU NIPDAU | N / A for Pkg Type | -40 to 85 | SN74HC14N | Samples |
| SN74HC14NSLE | OBSOLETE | SO | NS | 14 | | TBD | Call TI | Call TI | -40 to 85 | | |
| SN74HC14NSR | ACTIVE | SO | NS | 14 | 2000 | Green (RoHS & no Sb/Br) | CU NIPDAU | Level-1-260C-UNLIM | -40 to 85 | HC14 | Samples |
| SN74HC14NSRE4 | ACTIVE | SO | NS | 14 | 2000 | Green (RoHS & no Sb/Br) | CU NIPDAU | Level-1-260C-UNLIM | -40 to 85 | HC14 | Samples |
| SN74HC14PW | ACTIVE | TSSOP | PW | 14 | 90 | Green (RoHS & no Sb/Br) | CU NIPDAU | Level-1-260C-UNLIM | -40 to 85 | HC14 | Samples |
| SN74HC14PWE4 | ACTIVE | TSSOP | PW | 14 | 90 | Green (RoHS & no Sb/Br) | CU NIPDAU | Level-1-260C-UNLIM | -40 to 85 | HC14 | Samples |
| SN74HC14PWG4 | ACTIVE | TSSOP | PW | 14 | 90 | Green (RoHS & no Sb/Br) | CU NIPDAU | Level-1-260C-UNLIM | -40 to 85 | HC14 | Samples |
| SN74HC14PWLE | OBSOLETE | TSSOP | PW | 14 | | TBD | Call TI | Call TI | -40 to 85 | | |
| SN74HC14PWR | ACTIVE | TSSOP | PW | 14 | 2000 | Green (RoHS & no Sb/Br) | CU NIPDAU CU SN | Level-1-260C-UNLIM | -40 to 85 | HC14 | Samples |
| SN74HC14PWRE4 | ACTIVE | TSSOP | PW | 14 | 2000 | Green (RoHS & no Sb/Br) | CU NIPDAU | Level-1-260C-UNLIM | -40 to 85 | HC14 | Samples |
| SN74HC14PWRG4 | ACTIVE | TSSOP | PW | 14 | 2000 | Green (RoHS & no Sb/Br) | CU NIPDAU | Level-1-260C-UNLIM | -40 to 85 | HC14 | Samples |
| SN74HC14PWT | ACTIVE | TSSOP | PW | 14 | 250 | Green (RoHS & no Sb/Br) | CU NIPDAU | Level-1-260C-UNLIM | -40 to 85 | HC14 | Samples |

| Orderable Device | Status (1) | Package Type | Package Drawing | Pins | Package Qty | Eco Plan (2) | Lead/Ball Finish (6) | MSL Peak Temp (3) | Op Temp (°C) | Device Marking (4/5) | Samples |
|------------------|---------------|--------------|--------------------|------|----------------|----------------------------|-------------------------|----------------------|--------------|------------------------------|-------------------------|
| SN74HC14PWTG4 | ACTIVE | TSSOP | PW | 14 | 250 | Green (RoHS & no Sb/Br) | CU NIPDAU | Level-1-260C-UNLIM | -40 to 85 | HC14 | Samples |
| SNJ54HC14FK | ACTIVE | LCCC | FK | 20 | 1 | TBD | POST-PLATE | N / A for Pkg Type | -55 to 125 | 84091012A SNJ54HC 14FK | Samples |
| SNJ54HC14J | ACTIVE | CDIP | J | 14 | 1 | TBD | A42 | N / A for Pkg Type | -55 to 125 | 8409101CA SNJ54HC14J | Samples |
| SNJ54HC14W | ACTIVE | CFP | W | 14 | 1 | TBD | A42 | N / A for Pkg Type | -55 to 125 | 8409101DA SNJ54HC14W | Samples |

(1) The marketing status values are defined as follows:

ACTIVE: Product device recommended for new designs.

LIFEBUY: TI has announced that the device will be discontinued, and a lifetime-buy period is in effect.

NRND: Not recommended for new designs. Device is in production to support existing customers, but TI does not recommend using this part in a new design.

PREVIEW: Device has been announced but is not in production. Samples may or may not be available.

OBSELETE: TI has discontinued the production of the device.

(2) Eco Plan - The planned eco-friendly classification: Pb-Free (RoHS), Pb-Free (RoHS Exempt), or Green (RoHS & no Sb/Br) - please check <http://www.ti.com/productcontent> for the latest availability information and additional product content details.

TBD: The Pb-Free/Green conversion plan has not been defined.

Pb-Free (RoHS): TI's terms "Lead-Free" or "Pb-Free" mean semiconductor products that are compatible with the current RoHS requirements for all 6 substances, including the requirement that lead not exceed 0.1% by weight in homogeneous materials. Where designed to be soldered at high temperatures, TI Pb-Free products are suitable for use in specified lead-free processes.

Pb-Free (RoHS Exempt): This component has a RoHS exemption for either 1) lead-based flip-chip solder bumps used between the die and package, or 2) lead-based die adhesive used between the die and leadframe. The component is otherwise considered Pb-Free (RoHS compatible) as defined above.

Green (RoHS & no Sb/Br): TI defines "Green" to mean Pb-Free (RoHS compatible), and free of Bromine (Br) and Antimony (Sb) based flame retardants (Br or Sb do not exceed 0.1% by weight in homogeneous material)

(3) MSL, Peak Temp. - The Moisture Sensitivity Level rating according to the JEDEC industry standard classifications, and peak solder temperature.

(4) There may be additional marking, which relates to the logo, the lot trace code information, or the environmental category on the device.

(5) Multiple Device Markings will be inside parentheses. Only one Device Marking contained in parentheses and separated by a "~" will appear on a device. If a line is indented then it is a continuation of the previous line and the two combined represent the entire Device Marking for that device.

(6) Lead/Ball Finish - Orderable Devices may have multiple material finish options. Finish options are separated by a vertical ruled line. Lead/Ball Finish values may wrap to two lines if the finish value exceeds the maximum column width.

Important Information and Disclaimer: The information provided on this page represents TI's knowledge and belief as of the date that it is provided. TI bases its knowledge and belief on information provided by third parties, and makes no representation or warranty as to the accuracy of such information. Efforts are underway to better integrate information from third parties. TI has taken and continues to take reasonable steps to provide representative and accurate information but may not have conducted destructive testing or chemical analysis on incoming materials and chemicals. TI and TI suppliers consider certain information to be proprietary, and thus CAS numbers and other limited information may not be available for release.

In no event shall TI's liability arising out of such information exceed the total purchase price of the TI part(s) at issue in this document sold by TI to Customer on an annual basis.

OTHER QUALIFIED VERSIONS OF SN54HC14, SN54HC14-SP, SN74HC14 :

- Catalog: [SN74HC14](#), [SN54HC14](#)

- Automotive: [SN74HC14-Q1](#), [SN74HC14-Q1](#)

- Military: [SN54HC14](#)

- Space: [SN54HC14-SP](#)

NOTE: Qualified Version Definitions:

- Catalog - TI's standard catalog product

- Automotive - Q100 devices qualified for high-reliability automotive applications targeting zero defects

- Military - QML certified for Military and Defense Applications

- Space - Radiation tolerant, ceramic packaging and qualified for use in Space-based application

TAPE AND REEL INFORMATION

QUADRANT ASSIGNMENTS FOR PIN 1 ORIENTATION IN TAPE

*All dimensions are nominal

| Device | Package Type | Package Drawing | Pins | SPQ | Reel Diameter (mm) | Reel Width W1 (mm) | A0 (mm) | B0 (mm) | K0 (mm) | P1 (mm) | W (mm) | Pin1 Quadrant |
|--------------|--------------|-----------------|------|------|--------------------|--------------------|---------|---------|---------|---------|--------|---------------|
| SN74HC14DBR | SSOP | DB | 14 | 2000 | 330.0 | 16.4 | 8.2 | 6.6 | 2.5 | 12.0 | 16.0 | Q1 |
| SN74HC14DR | SOIC | D | 14 | 2500 | 330.0 | 16.4 | 6.5 | 9.0 | 2.1 | 8.0 | 16.0 | Q1 |
| SN74HC14DR | SOIC | D | 14 | 2500 | 330.0 | 16.8 | 6.5 | 9.5 | 2.3 | 8.0 | 16.0 | Q1 |
| SN74HC14DR | SOIC | D | 14 | 2500 | 330.0 | 16.4 | 6.5 | 9.0 | 2.1 | 8.0 | 16.0 | Q1 |
| SN74HC14DRG3 | SOIC | D | 14 | 2500 | 330.0 | 16.8 | 6.5 | 9.5 | 2.3 | 8.0 | 16.0 | Q1 |
| SN74HC14DRG4 | SOIC | D | 14 | 2500 | 330.0 | 16.4 | 6.5 | 9.0 | 2.1 | 8.0 | 16.0 | Q1 |
| SN74HC14DT | SOIC | D | 14 | 250 | 330.0 | 16.4 | 6.5 | 9.0 | 2.1 | 8.0 | 16.0 | Q1 |
| SN74HC14PWR | TSSOP | PW | 14 | 2000 | 330.0 | 12.4 | 6.9 | 5.6 | 1.6 | 8.0 | 12.0 | Q1 |
| SN74HC14PWT | TSSOP | PW | 14 | 250 | 330.0 | 12.4 | 6.9 | 5.6 | 1.6 | 8.0 | 12.0 | Q1 |

TAPE AND REEL BOX DIMENSIONS

*All dimensions are nominal

| Device | Package Type | Package Drawing | Pins | SPQ | Length (mm) | Width (mm) | Height (mm) |
|--------------|--------------|-----------------|------|------|-------------|------------|-------------|
| SN74HC14DBR | SSOP | DB | 14 | 2000 | 367.0 | 367.0 | 38.0 |
| SN74HC14DR | SOIC | D | 14 | 2500 | 333.2 | 345.9 | 28.6 |
| SN74HC14DR | SOIC | D | 14 | 2500 | 364.0 | 364.0 | 27.0 |
| SN74HC14DR | SOIC | D | 14 | 2500 | 367.0 | 367.0 | 38.0 |
| SN74HC14DRG3 | SOIC | D | 14 | 2500 | 364.0 | 364.0 | 27.0 |
| SN74HC14DRG4 | SOIC | D | 14 | 2500 | 333.2 | 345.9 | 28.6 |
| SN74HC14DT | SOIC | D | 14 | 250 | 367.0 | 367.0 | 38.0 |
| SN74HC14PWR | TSSOP | PW | 14 | 2000 | 367.0 | 367.0 | 35.0 |
| SN74HC14PWT | TSSOP | PW | 14 | 250 | 367.0 | 367.0 | 35.0 |

J (R-GDIP-T**)

14 LEADS SHOWN

CERAMIC DUAL IN-LINE PACKAGE



| DIM \ PINS ** | 14 | 16 | 18 | 20 |
|---------------|------------------------|------------------------|------------------------|------------------------|
| A | 0.300 (7,62) BSC | 0.300 (7,62) BSC | 0.300 (7,62) BSC | 0.300 (7,62) BSC |
| B MAX | 0.785 (19,94) | .840 (21,34) | 0.960 (24,38) | 1.060 (26,92) |
| B MIN | — | — | — | — |
| C MAX | 0.300 (7,62) | 0.300 (7,62) | 0.310 (7,87) | 0.300 (7,62) |
| C MIN | 0.245 (6,22) | 0.245 (6,22) | 0.220 (5,59) | 0.245 (6,22) |



4040083/F 03/03

- NOTES:
- All linear dimensions are in inches (millimeters).
 - This drawing is subject to change without notice.
 - This package is hermetically sealed with a ceramic lid using glass frit.
 - Index point is provided on cap for terminal identification only on press ceramic glass frit seal only.
 - Falls within MIL STD 1835 GDIP1-T14, GDIP1-T16, GDIP1-T18 and GDIP1-T20.

W (R-GDFP-F14)

CERAMIC DUAL FLATPACK



- NOTES:
- A. All linear dimensions are in inches (millimeters).
 - B. This drawing is subject to change without notice.
 - C. This package can be hermetically sealed with a ceramic lid using glass frit.
 - D. Index point is provided on cap for terminal identification only.
 - E. Falls within MIL STD 1835 GDFP1-F14

FK (S-CQCC-N**)

LEADLESS CERAMIC CHIP CARRIER

28 TERMINAL SHOWN



| NO. OF TERMINALS ** | A | | B | |
|---------------------|------------------|------------------|------------------|------------------|
| | MIN | MAX | MIN | MAX |
| 20 | 0.342 (8,69) | 0.358 (9,09) | 0.307 (7,80) | 0.358 (9,09) |
| 28 | 0.442 (11,23) | 0.458 (11,63) | 0.406 (10,31) | 0.458 (11,63) |
| 44 | 0.640 (16,26) | 0.660 (16,76) | 0.495 (12,58) | 0.560 (14,22) |
| 52 | 0.740 (18,78) | 0.761 (19,32) | 0.495 (12,58) | 0.560 (14,22) |
| 68 | 0.938 (23,83) | 0.962 (24,43) | 0.850 (21,6) | 0.858 (21,8) |
| 84 | 1.141 (28,99) | 1.165 (29,59) | 1.047 (26,6) | 1.063 (27,0) |



4040140/D 01/11

- NOTES:
- All linear dimensions are in inches (millimeters).
 - This drawing is subject to change without notice.
 - This package can be hermetically sealed with a metal lid.
 - Falls within JEDEC MS-004

N (R-PDIP-T**)

PLASTIC DUAL-IN-LINE PACKAGE

16 PINS SHOWN



- NOTES:
- A. All linear dimensions are in inches (millimeters).
 - B. This drawing is subject to change without notice.
 - $\triangle C$ Falls within JEDEC MS-001, except 18 and 20 pin minimum body length (Dim A).
 - $\triangle D$ The 20 pin end lead shoulder width is a vendor option, either half or full width.

D (R-PDSO-G14)

PLASTIC SMALL OUTLINE



- NOTES:
- A. All linear dimensions are in inches (millimeters).
 - B. This drawing is subject to change without notice.
 - Body length does not include mold flash, protrusions, or gate burrs. Mold flash, protrusions, or gate burrs shall not exceed 0.006 (0,15) each side.
 - Body width does not include interlead flash. Interlead flash shall not exceed 0.017 (0,43) each side.
 - E. Reference JEDEC MS-012 variation AB.

D (R-PDSO-G14)

PLASTIC SMALL OUTLINE



- NOTES:
- All linear dimensions are in millimeters.
 - This drawing is subject to change without notice.
 - Publication IPC-7351 is recommended for alternate designs.
 - Laser cutting apertures with trapezoidal walls and also rounding corners will offer better paste release. Customers should contact their board assembly site for stencil design recommendations. Refer to IPC-7525 for other stencil recommendations.
 - Customers should contact their board fabrication site for solder mask tolerances between and around signal pads.

PW (R-PDSO-G14)

PLASTIC SMALL OUTLINE



- NOTES:
- A. All linear dimensions are in millimeters. Dimensioning and tolerancing per ASME Y14.5M-1994.
 - B. This drawing is subject to change without notice.
 - C. Body length does not include mold flash, protrusions, or gate burrs. Mold flash, protrusions, or gate burrs shall not exceed 0,15 each side.
 - D. Body width does not include interlead flash. Interlead flash shall not exceed 0,25 each side.
 - E. Falls within JEDEC MO-153

PW (R-PDSO-G14)

PLASTIC SMALL OUTLINE



- NOTES:
- All linear dimensions are in millimeters.
 - This drawing is subject to change without notice.
 - Publication IPC-7351 is recommended for alternate designs.
 - Laser cutting apertures with trapezoidal walls and also rounding corners will offer better paste release. Customers should contact their board assembly site for stencil design recommendations. Refer to IPC-7525 for other stencil recommendations.
 - Customers should contact their board fabrication site for solder mask tolerances between and around signal pads.

MECHANICAL DATA

NS (R-PDSO-G**)

PLASTIC SMALL-OUTLINE PACKAGE

14-PINS SHOWN



- NOTES:
- A. All linear dimensions are in millimeters.
 - B. This drawing is subject to change without notice.
 - C. Body dimensions do not include mold flash or protrusion, not to exceed 0,15.

DB (R-PDSO-G**)

PLASTIC SMALL-OUTLINE

28 PINS SHOWN



- NOTES: A. All linear dimensions are in millimeters.
 B. This drawing is subject to change without notice.
 C. Body dimensions do not include mold flash or protrusion not to exceed 0,15.
 D. Falls within JEDEC MO-150

IMPORTANT NOTICE

Texas Instruments Incorporated and its subsidiaries (TI) reserve the right to make corrections, enhancements, improvements and other changes to its semiconductor products and services per JESD46, latest issue, and to discontinue any product or service per JESD48, latest issue. Buyers should obtain the latest relevant information before placing orders and should verify that such information is current and complete. All semiconductor products (also referred to herein as "components") are sold subject to TI's terms and conditions of sale supplied at the time of order acknowledgment.

TI warrants performance of its components to the specifications applicable at the time of sale, in accordance with the warranty in TI's terms and conditions of sale of semiconductor products. Testing and other quality control techniques are used to the extent TI deems necessary to support this warranty. Except where mandated by applicable law, testing of all parameters of each component is not necessarily performed.

TI assumes no liability for applications assistance or the design of Buyers' products. Buyers are responsible for their products and applications using TI components. To minimize the risks associated with Buyers' products and applications, Buyers should provide adequate design and operating safeguards.

TI does not warrant or represent that any license, either express or implied, is granted under any patent right, copyright, mask work right, or other intellectual property right relating to any combination, machine, or process in which TI components or services are used. Information published by TI regarding third-party products or services does not constitute a license to use such products or services or a warranty or endorsement thereof. Use of such information may require a license from a third party under the patents or other intellectual property of the third party, or a license from TI under the patents or other intellectual property of TI.

Reproduction of significant portions of TI information in TI data books or data sheets is permissible only if reproduction is without alteration and is accompanied by all associated warranties, conditions, limitations, and notices. TI is not responsible or liable for such altered documentation. Information of third parties may be subject to additional restrictions.

Resale of TI components or services with statements different from or beyond the parameters stated by TI for that component or service voids all express and any implied warranties for the associated TI component or service and is an unfair and deceptive business practice. TI is not responsible or liable for any such statements.

Buyer acknowledges and agrees that it is solely responsible for compliance with all legal, regulatory and safety-related requirements concerning its products, and any use of TI components in its applications, notwithstanding any applications-related information or support that may be provided by TI. Buyer represents and agrees that it has all the necessary expertise to create and implement safeguards which anticipate dangerous consequences of failures, monitor failures and their consequences, lessen the likelihood of failures that might cause harm and take appropriate remedial actions. Buyer will fully indemnify TI and its representatives against any damages arising out of the use of any TI components in safety-critical applications.

In some cases, TI components may be promoted specifically to facilitate safety-related applications. With such components, TI's goal is to help enable customers to design and create their own end-product solutions that meet applicable functional safety standards and requirements. Nonetheless, such components are subject to these terms.

No TI components are authorized for use in FDA Class III (or similar life-critical medical equipment) unless authorized officers of the parties have executed a special agreement specifically governing such use.

Only those TI components which TI has specifically designated as military grade or "enhanced plastic" are designed and intended for use in military/aerospace applications or environments. Buyer acknowledges and agrees that any military or aerospace use of TI components which have **not** been so designated is solely at the Buyer's risk, and that Buyer is solely responsible for compliance with all legal and regulatory requirements in connection with such use.

TI has specifically designated certain components as meeting ISO/TS16949 requirements, mainly for automotive use. In any case of use of non-designated products, TI will not be responsible for any failure to meet ISO/TS16949.

Products

| | |
|------------------------------|--|
| Audio | www.ti.com/audio |
| Amplifiers | amplifier.ti.com |
| Data Converters | dataconverter.ti.com |
| DLP® Products | www.dlp.com |
| DSP | dsp.ti.com |
| Clocks and Timers | www.ti.com/clocks |
| Interface | interface.ti.com |
| Logic | logic.ti.com |
| Power Mgmt | power.ti.com |
| Microcontrollers | microcontroller.ti.com |
| RFID | www.ti-rfid.com |
| OMAP Applications Processors | www.ti.com/omap |
| Wireless Connectivity | www.ti.com/wirelessconnectivity |

Applications

| | |
|-------------------------------|--|
| Automotive and Transportation | www.ti.com/automotive |
| Communications and Telecom | www.ti.com/communications |
| Computers and Peripherals | www.ti.com/computers |
| Consumer Electronics | www.ti.com/consumer-apps |
| Energy and Lighting | www.ti.com/energy |
| Industrial | www.ti.com/industrial |
| Medical | www.ti.com/medical |
| Security | www.ti.com/security |
| Space, Avionics and Defense | www.ti.com/space-avionics-defense |
| Video and Imaging | www.ti.com/video |

TI E2E Community

e2e.ti.com