

Chip EMIFIL® LC Combined Type for Large Current NFE61HT□□□□2A9□ Reference Specification [AEC-Q200]

1. Scope

This reference specification applies to Chip EMIFIL® LC Combined Type for Large Current NFE61H Series for Automotive Electronics based on AEC-Q200.

2. Part Numbering

NF	E	61	HT	101	Z	2A	9	L
Product ID	Structure	Dimension (L×W)	Features	Capacitance	Characteristics	Rated Voltage	Electrode	Packaging Code
(L: Taping / B: Bulk)								

3. Rating

Customer Part Number	Murata Part Number	Capacitance	Rated Voltage	Withstanding Voltage	Rated Current	Insulation Resistance	ESD Rank 2:2kV
	NFE61HT330U2A9L NFE61HT330U2A9B	33pF ± 30%	100 V (DC)	250 V(DC)	2 A(DC)	1000 MΩ min.	2
	NFE61HT680R2A9L NFE61HT680R2A9B	68pF ± 30%					
	NFE61HT101Z2A9L NFE61HT101Z2A9B	100pF ± 30%					
	NFE61HT181C2A9L NFE61HT181C2A9B	180pF ± 30%					
	NFE61HT361C2A9L NFE61HT361C2A9B	360pF ± 20%					
	NFE61HT681D2A9L NFE61HT681D2A9B	680pF ± 30%					
	NFE61HT102F2A9L NFE61HT102F2A9B	1000pF ± $\begin{smallmatrix} 8 \\ 2 \end{smallmatrix} \%$					
	NFE61HT332Z2A9L NFE61HT332Z2A9B	3300pF ± $\begin{smallmatrix} 8 \\ 2 \end{smallmatrix} \%$					

• Operating Temperature: - 55 °C to + 125 °C

• Storage Temperature: - 55 °C to + 125 °C

4. Standard Testing Condition

<Unless otherwise specified>

Temperature : Ordinary Temp. 15°C to 35°C

Humidity : Ordinary Humidity 25 %(RH) to 85 %(RH)

<In case of doubt>

Temperature: 20°C ± 2°C

Humidity : 60 %(RH) to 70 %(RH)

Atmospheric pressure : 86kPa to 106kPa

5. Style and Dimensions

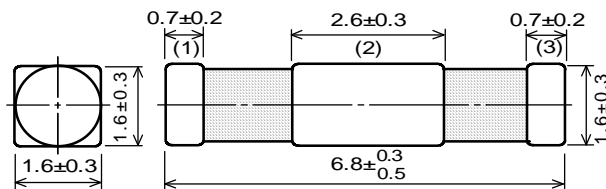

■ Equivalent Circuit

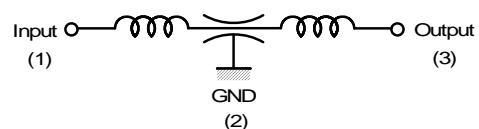

* (1),(3):No Polarity

■ Unit Mass(Typical value)

0.062g

Note : Gap and bend between ceramic capacitor(*) and ferrite bead(*1) may come out as illustrated below, however, these are not affect the performance, mounting and reliability of the products.

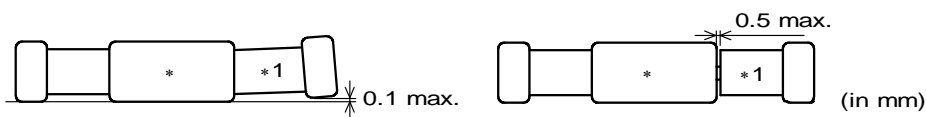

■ Insertion Loss Characteristics (I.L.) (Typ.) (50Ω system)

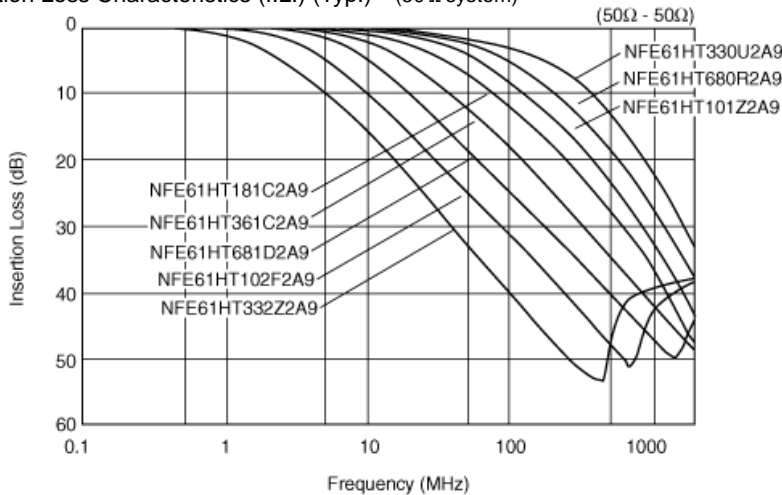

6. Marking

No marking.

7. Electrical Performance

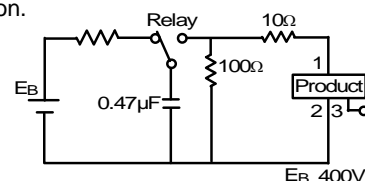
No.	Item	Specification	Test Method															
7.1	Capacitance	Meet item 3.	<p><u>Table 1</u></p> <table border="1"> <thead> <tr> <th>Capacitance</th> <th>Voltage</th> <th>Frequency</th> </tr> </thead> <tbody> <tr> <td>33,68,100 (pF)</td> <td>1 to 5 V(rms)</td> <td>1MHz±10%</td> </tr> <tr> <td>180,360,680</td> <td>1±0.2 V(rms)</td> <td>1kHz±10%</td> </tr> <tr> <td>1000,3300 (pF)</td> <td></td> <td></td> </tr> </tbody> </table>	Capacitance	Voltage	Frequency	33,68,100 (pF)	1 to 5 V(rms)	1MHz±10%	180,360,680	1±0.2 V(rms)	1kHz±10%	1000,3300 (pF)					
Capacitance	Voltage	Frequency																
33,68,100 (pF)	1 to 5 V(rms)	1MHz±10%																
180,360,680	1±0.2 V(rms)	1kHz±10%																
1000,3300 (pF)																		
7.2	Insulation Resistance(I.R.)	Meet item 3.	Voltage : 100 V(DC) Time : 60 ± 5 seconds															
7.3	Withstanding Voltage	Products shall not be damaged.	Test Voltage : 250 V(DC) Testing Time : 1 to 5 seconds Limit the charging current: 10mA max.															
7.4	Resistance to Surge Voltage	Meet Table 2. <table border="1"> <thead> <tr> <th colspan="2">Table 2</th> </tr> <tr> <th>Appearance</th> <th>No damaged</th> </tr> </thead> <tbody> <tr> <td rowspan="2">Cap. Change</td> <td>33,68,100 180,360 680 (pF)</td> <td>within ±15%</td> </tr> <tr> <td>1000 3300 (pF)</td> <td>within ±30%</td> </tr> <tr> <td>I.R.</td> <td>1000 MΩ min.</td> <td></td> </tr> <tr> <td>Withstanding Voltage</td> <td>No damaged</td> <td></td> </tr> </tbody> </table>	Table 2		Appearance	No damaged	Cap. Change	33,68,100 180,360 680 (pF)	within ±15%	1000 3300 (pF)	within ±30%	I.R.	1000 MΩ min.		Withstanding Voltage	No damaged		Attenuating transient voltage of exponential function shall be applied to products on the condition.  Peak Voltage : 400 V Force Period : 1 s The number of Surges : 10 ⁵
Table 2																		
Appearance	No damaged																	
Cap. Change	33,68,100 180,360 680 (pF)	within ±15%																
	1000 3300 (pF)	within ±30%																
I.R.	1000 MΩ min.																	
Withstanding Voltage	No damaged																	

8. Q200 Requirement

8-1. Performance (based on Table 13 for Ferrite EMI SUPPRESSORS/FILTERS)

AEC-Q200 Rev.D issued June. 1 2010

AEC-Q200			Murata Specification / Deviation	
No.	Stress	Test Method		
3	High Temperature Exposure (Storage)	1000hours at 125C Set for 24hours at room temperature, then measured.	Meet TABLE A after testing. <u>Table A</u>	
			Appearance	No damage
			Capacitance Change (33pF-100pF: 1MHz+/-10%) (180pF-3300pF: 1kHz+/-10%)	33pF to 680pF Within +/-15% at 20C
				1000pF to 3300pF Within +/-30% at 20C
			I.R.	1000M ohm min.
			Withstanding Voltage	No damage

AEC-Q200			Murata Specification / Deviation		
No.	Stress	Test Method			
4	Temperature Cycling	1000cycles(-55C to 125C) Measurement at 24±2 hours after test conclusion.	Meet Table B after testing. Table B		
			Appearance	No damage	
			Capacitance Change (33pF-100pF: 1MHz+/-10%) (180pF-3300pF: 1kHz+/-10%)	33pF to 680pF	Within +/-15% at 20C
				1000pF to 3300pF	Within +/-30% at 20C
			I.R.	100M ohm min	
Withstanding Voltage	No damage				
5	Destructive Physical Analysis	Per EIA469 No electrical tests	No defects		
7	Biased Humidity	1000hours 85C/85%RH. Apply Maximum rated Voltage and current. Measurement at 24+/-2 hours after test conclusion.	Meet Table B after testing.		
8	Operational Life	1000hours at 125C Apply Maximum rated Current. Measurement at 24+/-2 hours after test conclusion.	Meet Table B after testing.		
9	External Visual	Visual inspection	No abnormalities		
10	Physical Dimension	Meet ITEM 4 (Style and Dimensions)	No defects		
12	Resistance to Solvents	Per MIL-STD-202 Method 215	Not Applicable		
13	Mechanical Shock	Per MIL-STD-202 Method 213 Figure 1 of Method 213. Condition F(1500g's/0.5ms/Half sine) Three times each 6 direction.	Meet Table A after testing.		
14	Vibration	5g's for 20 minutes, 12cycles each of 3 orientations Oscillation Frequency : 10-2000Hz.	Meet Table A after testing.		
15	Resistance to Soldering Heat	No heating. 260C +/- degree C Immersion time 10s	Pre-heating: 150C+/-5C, 60s+/-5s Meet Table A after testing.		
17	ESD	Per AEC-Q200-002	Meet Table C after testing. ESD Rank: Refer to Item 3. Rating. Table C		
			Appearance	No damage	
			I.R.	1000M ohm min	
			Withstanding Voltage	No damage	
18	Solderability	Per J-STD-002	Method b : Not Applicable 75% of the terminations is to be soldered.		
19	Electrical Characterization	Measured :Capacitance	No defects		

AEC-Q200			Murata Specification / Deviation		
No.	Stress	Test Method			
20	Flammability	Per UL-94	Not Applicable		
21	Board Flex	Epoxy-PCB(1.6mm) Deflection 2mm(min) 60s minimum holding time	Meet Table D after testing. Table D		
			Capacitance Change (33pF-100pF: 1MHz+/-10%) (180pF-3300pF: 1kHz+/-10%)	33pF to 680pF 1000pF to 3300pF	Within +/-15% at 20C Within +/-30% at 20C
22	Terminal Strength	Per AEC-Q200-006 A force of 17.7N for 60sec	17.7N for 60sec No defects		
30	Electrical Transient Conduction	Per ISO-7637-2	Not Applicable		

10. Specification of Packaging

10.1. Appearance and Dimensions (12mm-wide plastic tape)

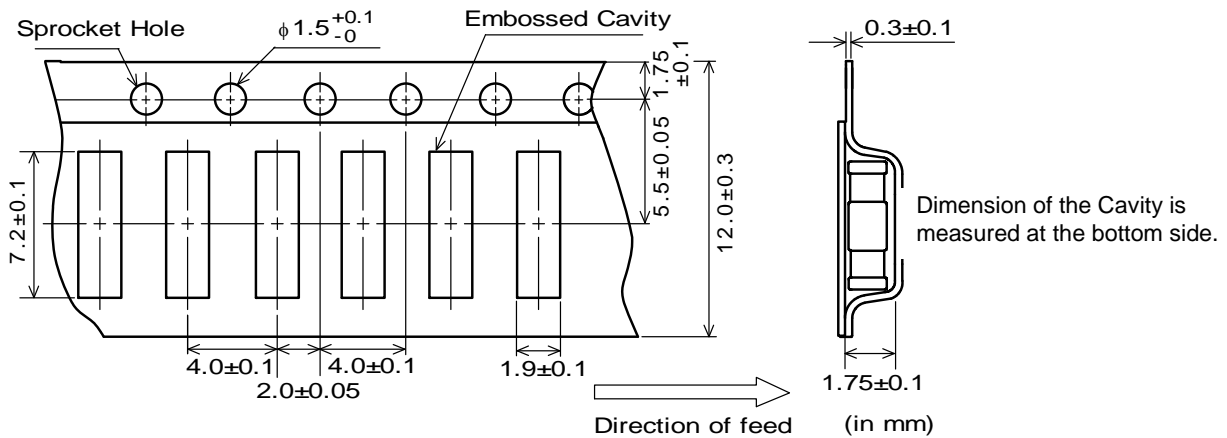

10.2. Specification of Taping

- (1) Packing quantity (standard quantity)
2500 pcs. / reel
- (2) Packing Method
Products shall be packaged in the cavity of the plastic tape and sealed with cover tape.
- (3) Sprocket Hole
The sprocket holes are to the right as the tape is pulled toward the user.
- (4) Spliced point
The cover tape have no spliced point.
- (5) Missing components number
Missing components number within 0.1% of the number per reel or 1 pc., whichever is greater, and are not continuous. The specified quantity per reel is kept.

10.3. Pull Strength of Plastic Tape and Cover Tape

Plastic tape	5N min.
Cover tape	10N min.

10.4. Peeling off force of cover tape

- 0.2N to 0.7N (minimum value is typical)
- * Speed of Peeling off : 300 mm / min

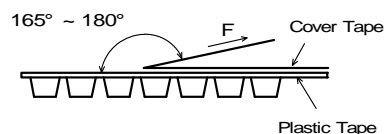

11. Standard Land Dimensions

The chip EMI filter suppresses noise by conducting the high-frequency noise element to ground.

Therefore, to get enough noise reduction, feed through holes which is connected to ground-plane should be arranged according to the figure to reinforce the ground-pattern.

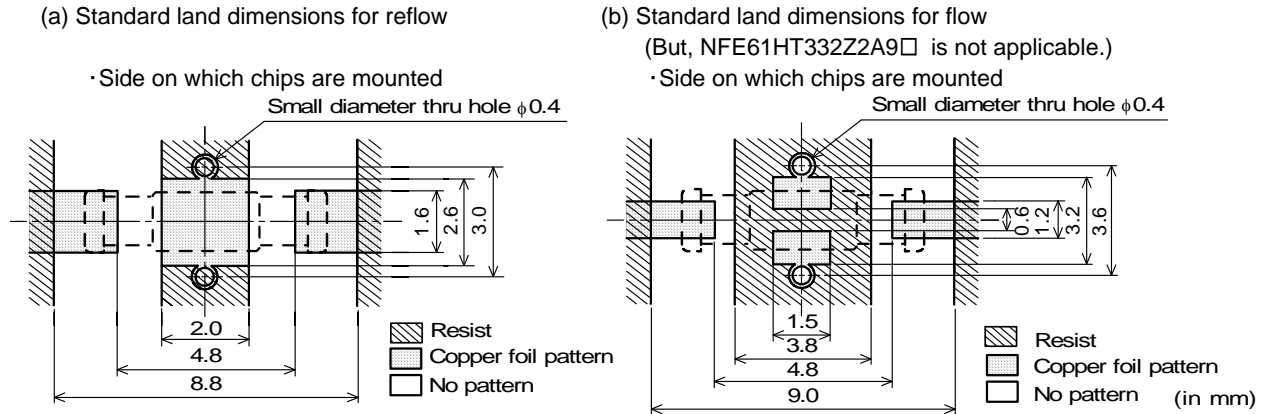

12. ⚠ Caution

Limitation of Applications

Please contact us before using our products for the applications listed below which require especially high reliability for the prevention of defects which might directly cause damage to the third party's life, body or property.

- (1)Aircraft equipment (2)Aerospace equipment (3)Undersea equipment (4)Power plant control equipment
 (5)Medical equipment (6)Transportation equipment(trains, ships, etc.) (7)Traffic signal equipment
 (8)Disaster prevention / crime prevention equipment (9)Data-processing equipment
 (10)Applications of similar complexity or with reliability requirements comparable to the applications listed in the above

13. Notice

This product is designed for solder mounting.

Please consult us in advance for applying other mounting method such as conductive adhesive.

13.1. Flux and Solder

Flux	Use rosin-based flux, Do not use highly acidic flux (with chlorine content exceeding 0.2(wt)%). Do not use water-soluble flux.
Solder	Use Sn-3.0Ag-0.5Cu solder

13.2. Note for Assembling

< Thermal Shock >

Pre-heating should be in such a way that the temperature difference between solder and products surface is limited to 100°C max. Also cooling into solvent after soldering should be in such a way that the temperature difference is limited to 100°C max.

<Consideration for mounting of 2.5mm pitch>

The mounting of 2.5mm pitch should be prevented on flow soldering to avoid an excess of solder volume.

< Exclusive Use of Reflow Soldering >

NFE61HT332Z2A9□ can only be soldered with reflow.

If it were soldered with flow, cracks might be caused in the ceramic body.

So, reflow soldering shall be applied for products.

13.3. Attention Regarding P.C.B. Bending

The following shall be considered when designing P.C.B.'s and laying out products.

- (1) P.C.B. shall be designed so that products are not subject to the mechanical stress for board warpage.

[Products direction]

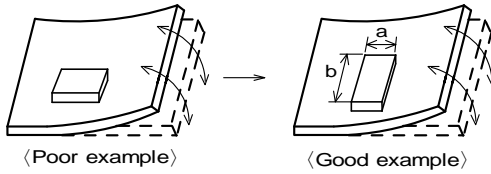

Products shall be located in the sideways direction (Length: $a < b$) to the mechanical stress.

- (2) Products location on P.C.B. near seam for separation.

Products (A,B,C,D) shall be located carefully so that products are not subject to the mechanical stress due to warping the board. Because they may be subjected the mechanical stress in order of $A > C > B \cong D$.

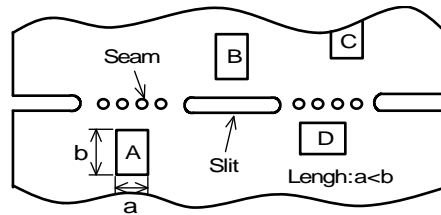

13.4. Standard Soldering Conditions

On flow soldering (e.g. double wave soldering), use the product in consideration of the conditions of solder, solder temperature and immersion time (melting time) because longer soldering time may cause the corrosion of the electrode.

On dipping soldering, use the product in consideration of the conditions of solder, solder temperature, flux, preheat and so on because de-wetting may be caused.

Standard soldering profile and the limit soldering profile is as follows.

The excessive soldering conditions may cause leaching of the electrode and/or resulting in the deterioration of product quality.

< Flow Soldering Profile >

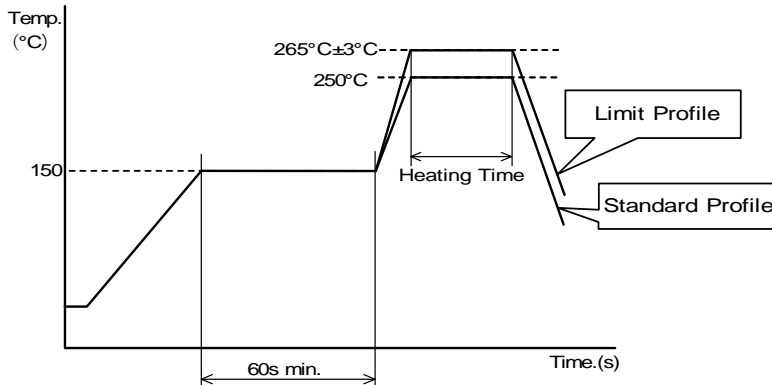

	Standard Profile	Limit Profile
Pre-heating	150°C , 60s min.	
Heating	250°C , 4s ~ 6s	265°C ± 3°C , 5s max.
Cycle of flow	2 times	2 times

< Reflow Soldering Profile >

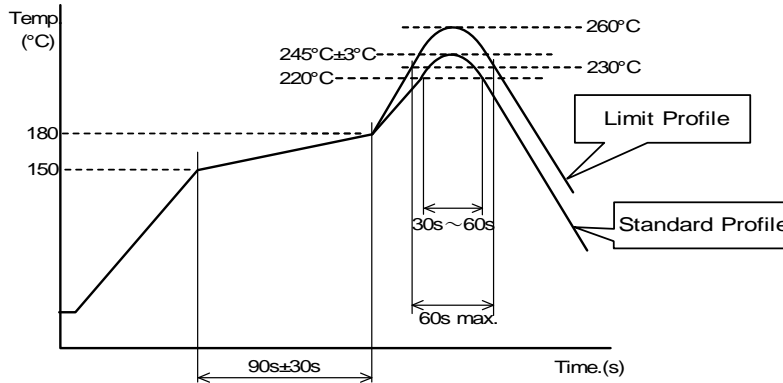

	Standard Profile	Limit Profile
Pre-heating	150°C ~ 180°C , 90s ± 30s	
Heating	above 220°C , 30s ~ 60s	above 230°C , 60s max.
Peak temperature	245°C ± 3°C	260°C , 10s
Cycle of reflow	2 times	2 times

13.5. Printing of Adhesive (Flow Soldering)

Adhesive amount shall be about 0.5mg for one position to obtain enough adhesive strength.
The adhesive position is as follows.

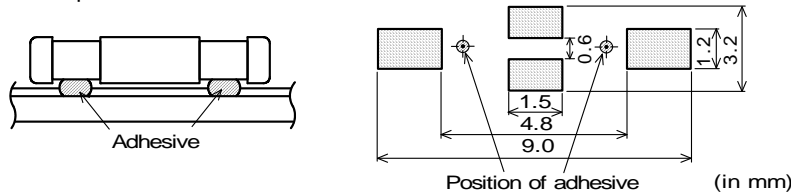

13.6. Solder paste printing for reflow

- Standard thickness of the solder paste should be 150µm to 200µm.
- Use the solder paste printing pattern of the right pattern.
- For the resist and copper foil pattern, use standard land dimensions.

• Standard printing pattern of solder paste.

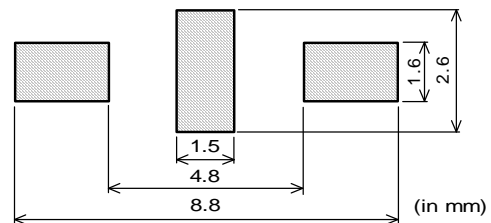

13.7. Reworking with Soldering iron

The following conditions shall be strictly followed when using a soldering iron.

- Pre-heating : 150°C, 1 min
- Tip temperature : 350°C max.
- Soldering time : 3(+1,-0) s
- Soldering iron output : 30W max.
- Tip diameter : φ 3mm max.
- Times : 2times max.

Note: Do not directly touch the products with the tip of the soldering iron in order to prevent the crack on the ceramic material due to the thermal shock.

13.8. Cleaning Conditions

Products shall be cleaned on the following conditions.

- (1) Cleaning temperature shall be limited to 60°C max. (40°C max. for IPA.)
- (2) Ultrasonic cleaning shall comply with the following conditions, with avoiding the resonance phenomenon at the mounted products and P.C.B.
Power: 20W / l max. Frequency: 28kHz to 40kHz Time: 5 minutes max.
- (3) Cleaner
 1. Cleaner
 - Isopropyl alcohol (IPA)
 2. Aqueous agent
 - PINE ALPHA ST-100S
- (4) There shall be no residual flux and residual cleaner after cleaning.
In the case of using aqueous agent, products shall be dried completely after rinse with de-ionized water in order to remove the cleaner.
- (5) Other cleaning
Please contact us.

13.9. Operating Environment

Do not use this product under the following environmental conditions, on deterioration of the performance, such as insulation resistance may result from the use.

- (1) in the corrodible atmosphere (acidic gases, alkaline gases, chlorine, sulfur gases, organic gases and etc.)
- (2) in the atmosphere where liquid such as organic solvent, may splash on the products.

13.10. Resin coating

It may affect on the product's performance when using resin for coating / molding products. So please pay your careful attention when you select resin. In prior to use, please make the reliability evaluation with the product mounted in your application set.

13.11. Handling of a substrate

After mounting products on a substrate, do not apply any stress to the product caused by bending or twisting to the substrate when cropping the substrate, inserting and removing a connector from the substrate or tightening screw to the substrate.

Excessive mechanical stress may cause cracking in the product.



13.12. Storage condition

(1) Storage period

Use the products within 12 months after delivered.

Solderability should be checked if this period is exceeded.

(2) Storage environment condition

• Products should be stored in the warehouse on the following conditions.

Temperature : - 10 °C to + 40 °C

Humidity : 15 % to 85% relative humidity No rapid change on temperature and humidity

- Don't keep products in corrosive gases such as sulfur, chlorine gas or acid, or it may cause oxidization of electrode, resulting in poor solderability.
- Products should be stored on the palette for the prevention of the influence from humidity, dust and so on.
- Products should be stored in the warehouse without heat shock, vibration, direct sunlight and so on.
- Products should be stored under the airtight packaged condition.

(3) Delivery

Care should be taken when transporting or handling product to avoid excessive vibration or mechanical shock.

14. ⚠ Notes

- (1) Please make sure that your product has been evaluated in view of your specifications with our product being mounted to your product.
- (2) You are requested not to use our product deviating from the agreed specifications.
- (3) The contents of this reference specification are subject to change without advance notice.
Please approve our product specifications or transact the approval sheet for product specifications before ordering.