

Features

- Advanced Process Technology
- Ultra Low On-Resistance
- Logic Level Gate Drive
- Enhanced dv/dt and di/dt capability
- 175°C Operating Temperature
- Fast Switching
- Repetitive Avalanche Allowed up to Tjmax
- Lead-Free, RoHS Compliant
- Automotive Qualified *

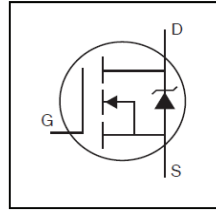

V_{DSS}	40V
R_{DS(on)} typ.	3.8mΩ
	max.
I_D (Silicon Limited)	122AⓄ
I_D (Package Limited)	56A

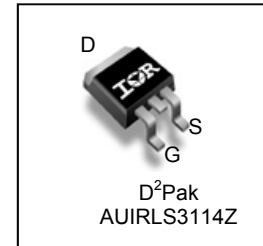

G	D	S
Gate	Drain	Source

Description

Specifically designed for Automotive applications, this HEXFET® Power MOSFET utilizes the latest processing techniques to achieve extremely low on-resistance per silicon area. Additional features of this design are a 175°C junction operating temperature, fast switching speed and improved repetitive avalanche rating. These features combine to make this design an extremely efficient and reliable device for use in Automotive applications and a wide variety of other applications.

Base part number	Package Type	Standard Pack		Orderable Part Number
		Form	Quantity	
AUIRLS3114Z	D²-Pak	Tube	50	AUIRLS3114Z
		Tape and Reel Left	800	AUIRLS3114ZTRL

Absolute Maximum Ratings

Stresses beyond those listed under “Absolute Maximum Ratings” may cause permanent damage to the device. These are stress ratings only; and functional operation of the device at these or any other condition beyond those indicated in the specifications is not implied. Exposure to absolute-maximum-rated conditions for extended periods may affect device reliability. The thermal resistance and power dissipation ratings are measured under board mounted and still air conditions. Ambient temperature (TA) is 25°C, unless otherwise specified.

Symbol	Parameter	Max.	Units
I _D @ T _C = 25°C	Continuous Drain Current, V _{GS} @ 10V (Silicon Limited)	122Ⓞ	A
I _D @ T _C = 100°C	Continuous Drain Current, V _{GS} @ 10V (Silicon Limited)	86Ⓞ	
I _D @ T _C = 25°C	Continuous Drain Current, V _{GS} @ 10V (Wirebond Limited)	56	
I _{DM}	Pulsed Drain Current ②	488	
P _D @T _C = 25°C	Maximum Power Dissipation	143	W
	Linear Derating Factor	0.95	W/°C
V _{GS}	Gate-to-Source Voltage	± 16	V
E _{AS}	Single Pulse Avalanche Energy (Thermally Limited) ③	168	mJ
E _{AS (Tested)}	Single Pulse Avalanche Energy (Tested)	518	
I _{AR}	Avalanche Current ②	See Fig.15,16, 12a, 12b	A
E _{AR}	Repetitive Avalanche Energy ②		mJ
dv/dt	Peak Diode Recovery ④	2.3	V/ns
T _J	Operating Junction and Storage Temperature Range	-55 to + 175	°C
T _{STG}			
	Soldering Temperature, for 10 seconds (1.6mm from case)	300	

Thermal Resistance

Symbol	Parameter	Typ.	Max.	Units
R _{θJC}	Junction-to-Case ⑤	—	1.05	°C/W
R _{θJA}	Junction-to-Ambient (PCB Mount) ⑦	—	40	

HEXFET® is a registered trademark of Infineon.

*Qualification standards can be found at www.infineon.com

Static @ T_J = 25°C (unless otherwise specified)

	Parameter	Min.	Typ.	Max.	Units	Conditions
V _{(BR)DSS}	Drain-to-Source Breakdown Voltage	40	—	—	V	V _{GS} = 0V, I _D = 250μA
ΔV _{(BR)DSS/ΔT_J}	Breakdown Voltage Temp. Coefficient	—	0.03	—	V/°C	Reference to 25°C, I _D = 1mA ②
R _{DS(on)}	Static Drain-to-Source On-Resistance	—	3.8	4.9	mΩ	V _{GS} = 10V, I _D = 56A ⑤
V _{GS(th)}	Gate Threshold Voltage	1.0	1.7	2.5	V	V _{DS} = V _{GS} , I _D = 100μA
ΔV _{GS(th)}	Gate Threshold Voltage Coefficient	—	-6.6	—	mV/°C	
g _{fs}	Forward Trans conductance	103	—	—	S	V _{DS} = 10V, I _D = 56A
R _{G(int)}	Internal Gate Resistance	—	0.8	—	Ω	
I _{DSS}	Drain-to-Source Leakage Current	—	—	20	μA	V _{DS} = 40V, V _{GS} = 0V
		—	—	250		V _{DS} = 40V, V _{GS} = 0V, T _J = 125°C
I _{GSS}	Gate-to-Source Forward Leakage	—	—	100	nA	V _{GS} = 16V
	Gate-to-Source Reverse Leakage	—	—	-100		V _{GS} = -16V

Dynamic Electrical Characteristics @ T_J = 25°C (unless otherwise specified)

Q _g	Total Gate Charge	—	35	53	nC	I _D = 56A
Q _{gs}	Gate-to-Source Charge	—	11	—		V _{DS} = 20V
Q _{gd}	Gate-to-Drain Charge	—	16	—		V _{GS} = 4.5V ⑤
t _{d(on)}	Turn-On Delay Time	—	28	—	ns	V _{DD} = 20V
t _r	Rise Time	—	271	—		I _D = 56A
t _{d(off)}	Turn-Off Delay Time	—	43	—		R _G = 3.7Ω
t _f	Fall Time	—	60	—		V _{GS} = 4.5V ⑤
C _{iss}	Input Capacitance	—	3617	—	pF	V _{GS} = 0V
C _{oss}	Output Capacitance	—	633	—		V _{DS} = 25V
C _{rss}	Reverse Transfer Capacitance	—	345	—		f = 1.0MHz, See Fig. 5
C _{oss}	Output Capacitance	—	2378	—		V _{GS} = 0V, V _{DS} = 1.0V, f = 1.0MHz
C _{oss}	Output Capacitance	—	570	—		V _{GS} = 0V, V _{DS} = 32V, f = 1.0MHz
C _{oss eff.}	Effective Output Capacitance	—	875	—		V _{GS} = 0V, V _{DS} = 0V to 32V ⑥

Diode Characteristics

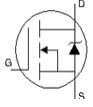
	Parameter	Min.	Typ.	Max.	Units	Conditions
I _S	Continuous Source Current (Body Diode)	—	—	122①	A	MOSFET symbol showing the integral reverse p-n junction diode. 
I _{SM}	Pulsed Source Current (Body Diode) ②	—	—	488		
V _{SD}	Diode Forward Voltage	—	—	1.3	V	T _J = 25°C, I _S = 56A, V _{GS} = 0V ③
t _{rr}	Reverse Recovery Time	—	33	50	ns	T _J = 25°C, I _F = 56A, V _{DD} = 20V di/dt = 100A/μs ④
Q _{rr}	Reverse Recovery Charge	—	32	48	nC	
t _{on}	Forward Turn-On Time	Intrinsic turn-on time is negligible (turn-on is dominated by L _S +L _D)				

Notes:

- ① Calculated continuous current based on maximum allowable junction temperature. Bond wire current limit is 56A. Note that current limitations arising from heating of the device leads may occur with some lead mounting arrangements.
- ② Repetitive rating; pulse width limited by max. junction temperature.
- ③ Limited by T_{Jmax}, starting T_J = 25°C, L = 0.107mH, R_G = 50Ω, I_{AS} = 56A, V_{GS} = 10V. Part not recommended for use above this value.
- ④ I_{SD} ≤ 56A, di/dt ≤ 263A/μs, V_{DD} ≤ V_{(BR)DSS}, T_J ≤ 175°C.
- ⑤ Pulse width ≤ 1.0ms; duty cycle ≤ 2%.
- ⑥ C_{oss eff.} is a fixed capacitance that gives the same charging time as C_{oss} while V_{DS} is rising from 0 to 80% V_{DSS}.
- ⑦ When mounted on 1" square PCB (FR-4 or G-10 Material). For recommended footprint and soldering techniques refer to application note #AN-994
- ⑧ R_θ is measured at T_J approximately 90°C.

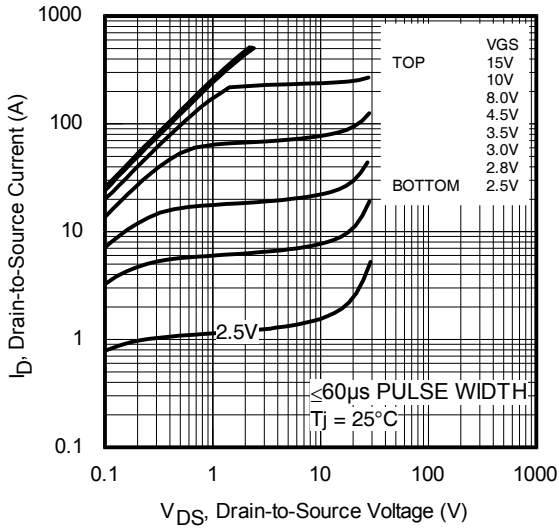
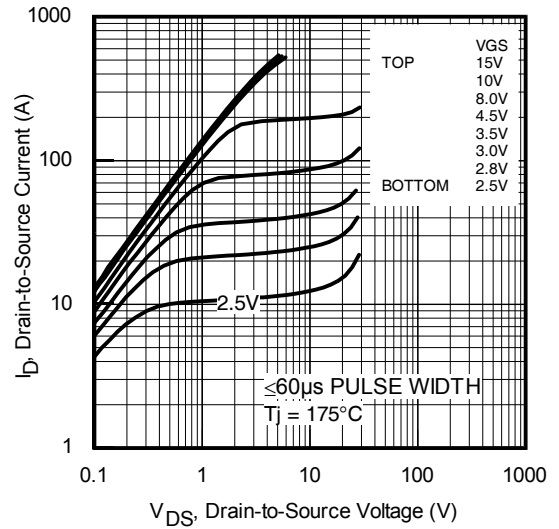
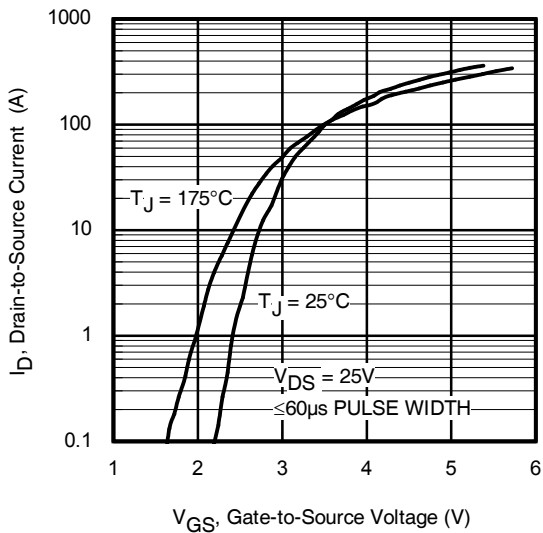
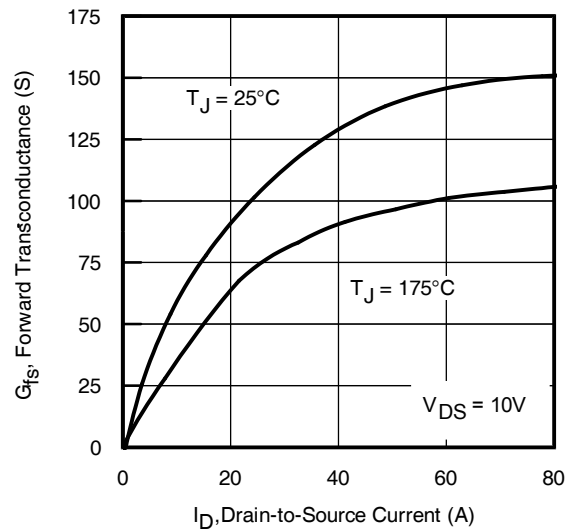
Fig. 1 Typical Output Characteristics

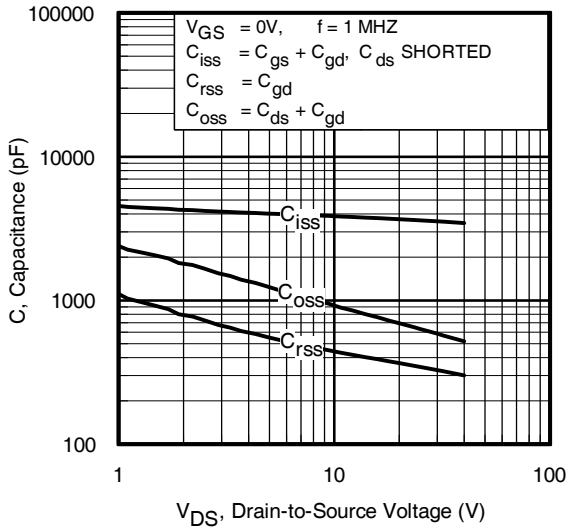
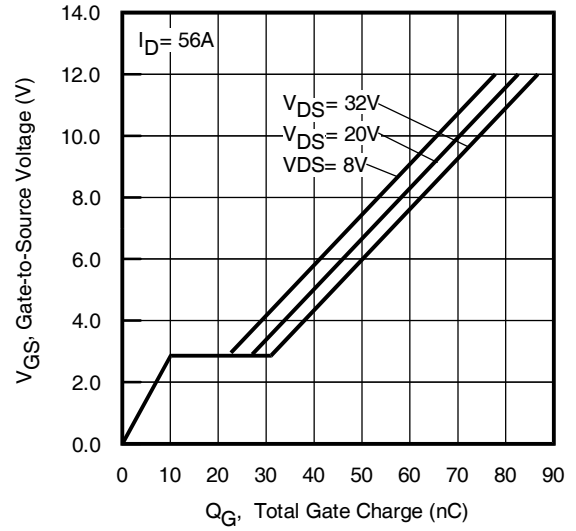
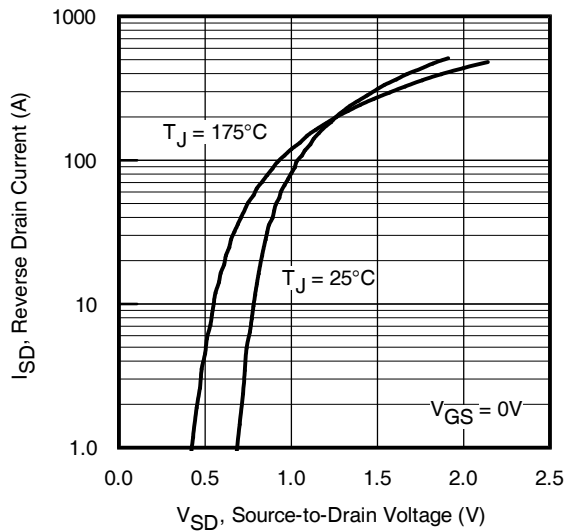
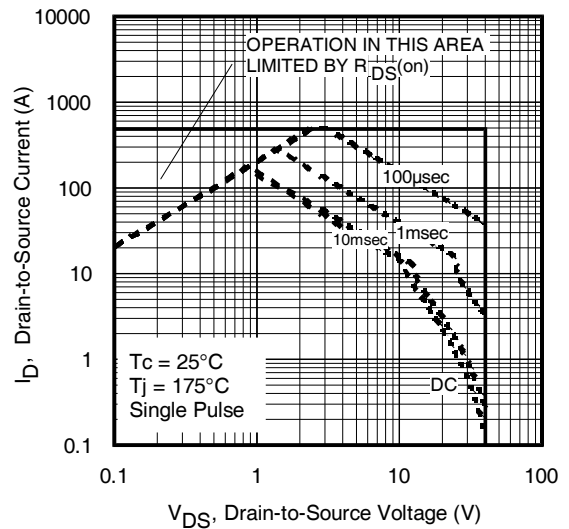
Fig. 2 Typical Output Characteristics

Fig. 3 Typical Transfer Characteristics

Fig. 4 Typical Forward Trans conductance vs. Drain Current

Fig 5. Typical Capacitance vs. Drain-to-Source Voltage

Fig 6. Typical Gate Charge vs. Gate-to-Source Voltage

Fig. 7 Typical Source-to-Drain Diode Forward Voltage

Fig 8. Maximum Safe Operating Area

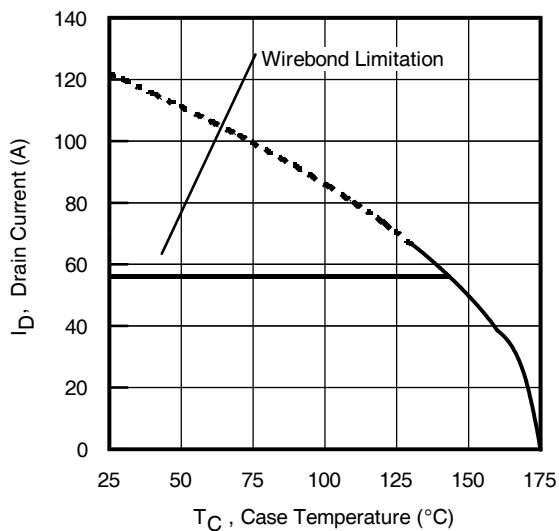

Fig 9. Maximum Drain Current vs. Case Temperature

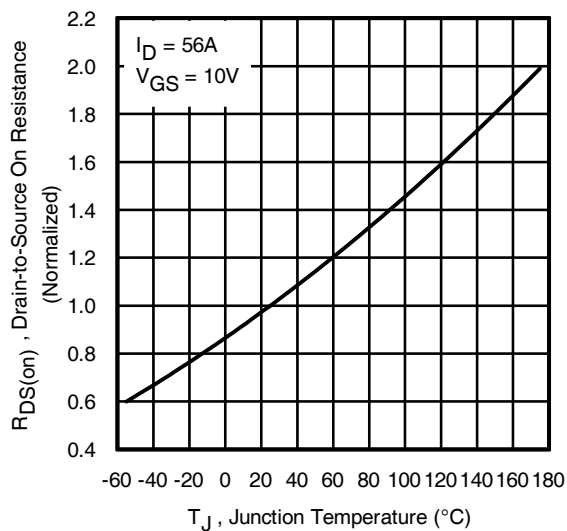

Fig 10. Normalized On-Resistance vs. Temperature

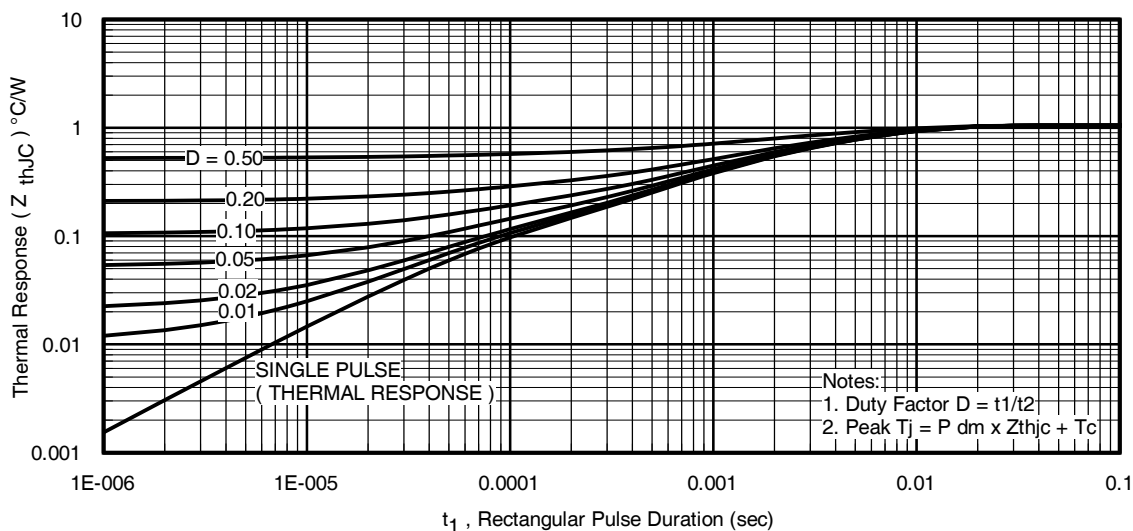
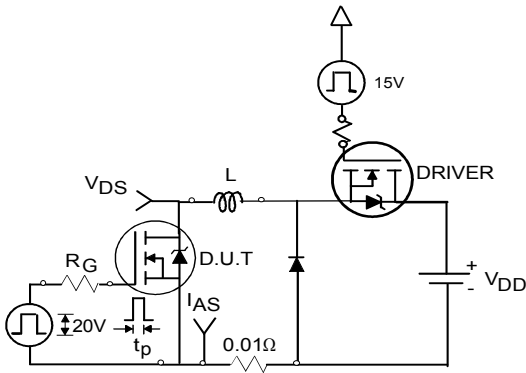
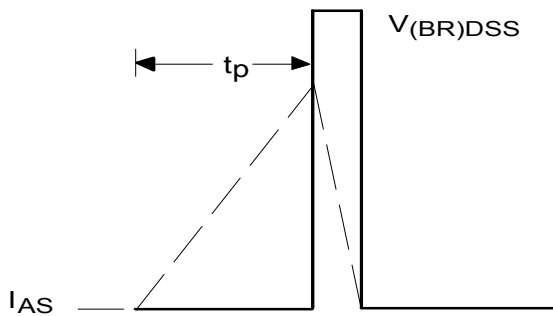
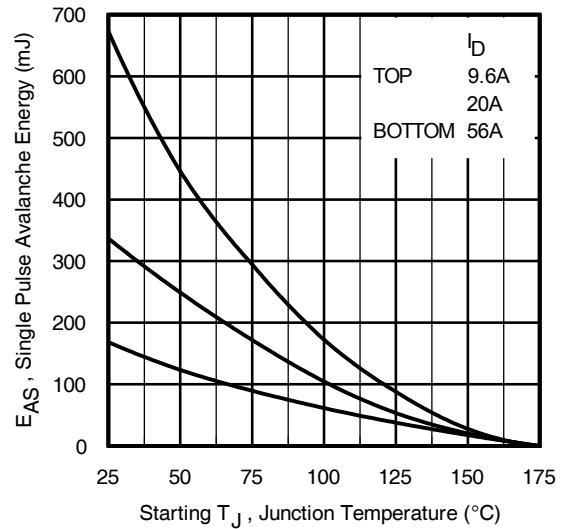
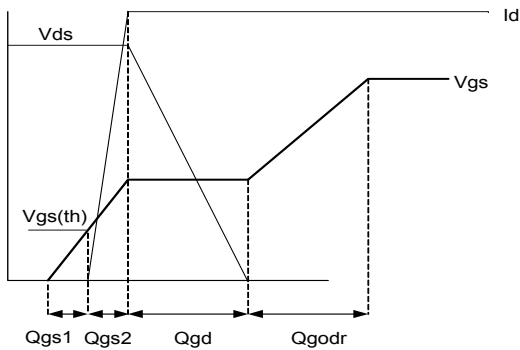
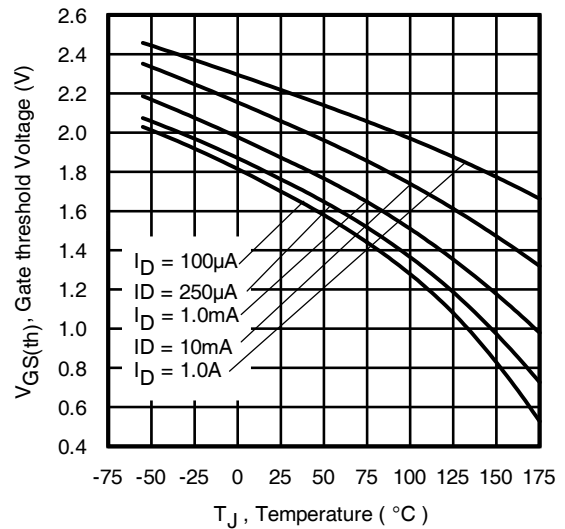
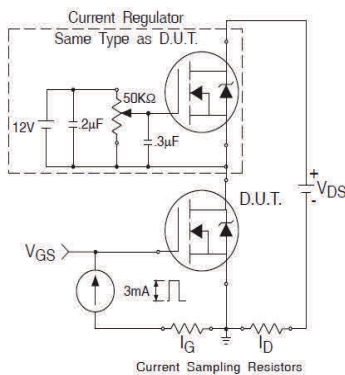
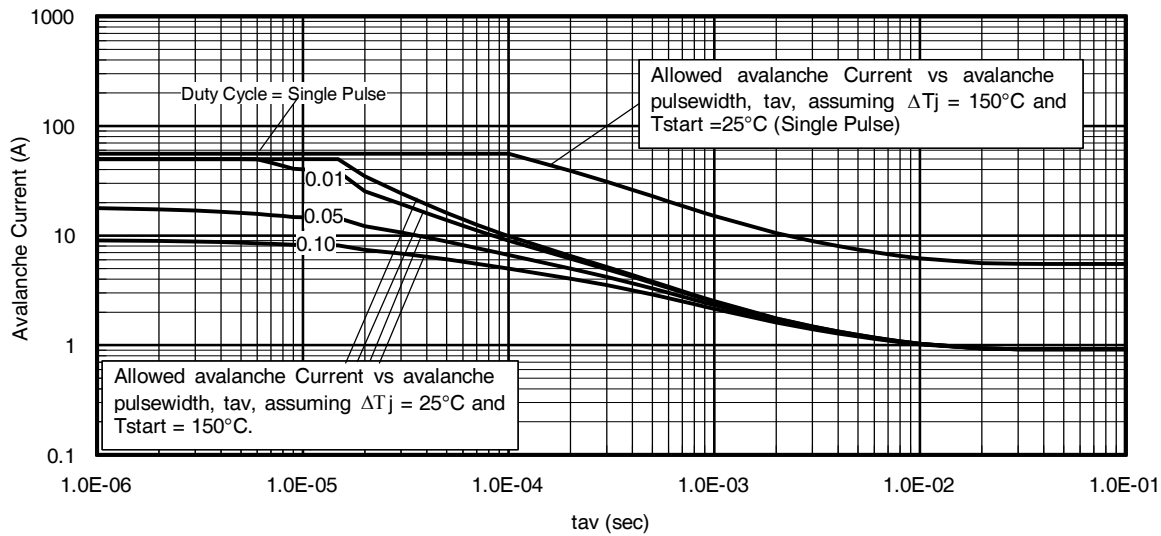
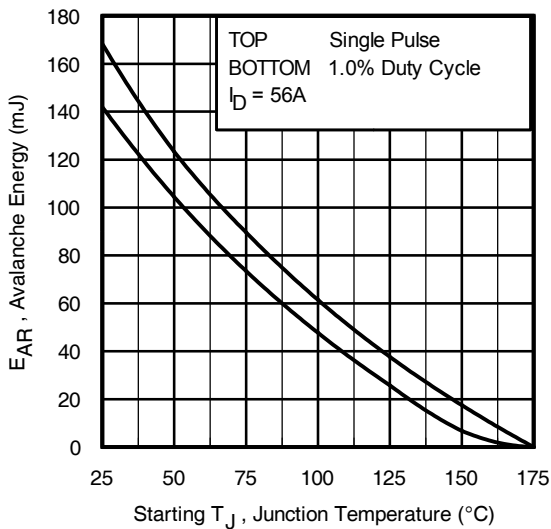

Fig 11. Maximum Effective Transient Thermal Impedance, Junction-to-Case

Fig 12a. Unclamped Inductive Test Circuit

Fig 12b. Unclamped Inductive Waveforms

Fig 12c. Maximum Avalanche Energy vs. Drain Current

Fig 13a. Gate Charge Waveform

Fig. 14 - Threshold Voltage vs. Temperature

Fig 13b. Gate Charge Test Circuit

Fig 15. Avalanche Current vs. Pulse width

Fig 16. Maximum Avalanche Energy vs. Temperature
**Notes on Repetitive Avalanche Curves , Figures 15, 16:
(For further info, see AN-1005 at www.infineon.com)**

1. Avalanche failures assumption:
Purely a thermal phenomenon and failure occurs at a temperature far in excess of T_{jmax} . This is validated for every part type.
2. Safe operation in Avalanche is allowed as long as T_{jmax} is not exceeded.
3. Equation below based on circuit and waveforms shown in Figures 12a, 12b.
4. $P_{D(ave)}$ = Average power dissipation per single avalanche pulse.
5. BV = Rated breakdown voltage (1.3 factor accounts for voltage increase during avalanche).
6. I_{av} = Allowable avalanche current.
7. ΔT = Allowable rise in junction temperature, not to exceed T_{jmax} (assumed as 25°C in Figure 11, 15).
 t_{av} = Average time in avalanche.
 D = Duty cycle in avalanche = $t_{av} \cdot f$
 $Z_{thJC}(D, t_{av})$ = Transient thermal resistance, see Figures 13)

$$P_{D(ave)} = 1/2 (1.3 \cdot BV \cdot I_{av}) = \Delta T / Z_{thJC}$$

$$I_{av} = 2\Delta T / [1.3 \cdot BV \cdot Z_{th}]$$

$$E_{AS(AR)} = P_{D(ave)} \cdot t_{av}$$

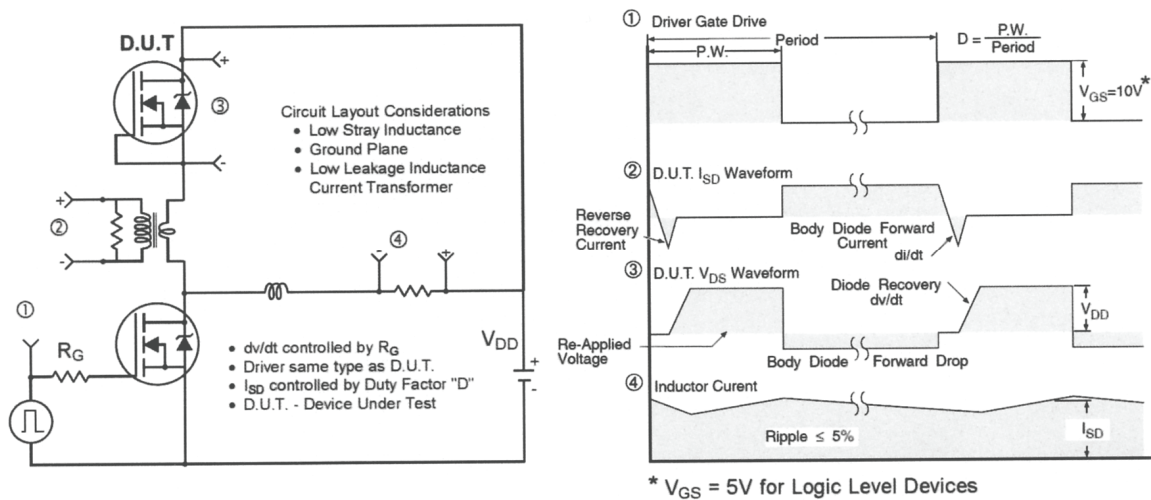

Fig 17. Peak Diode Recovery dv/dt Test Circuit for N-Channel HEXFET® Power MOSFETs

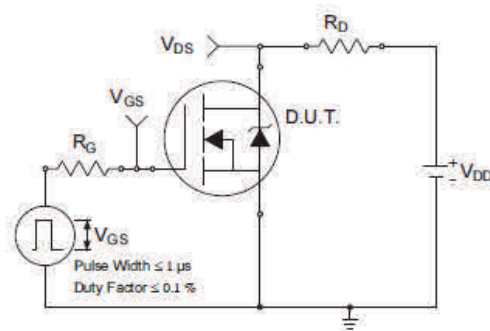

Fig 18a. Switching Time Test Circuit

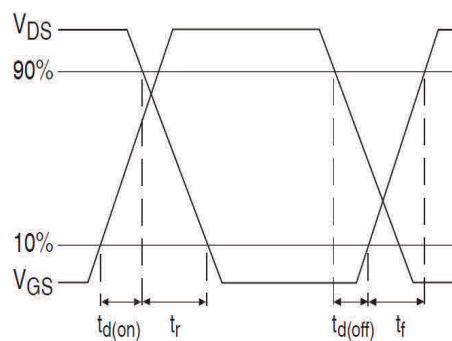
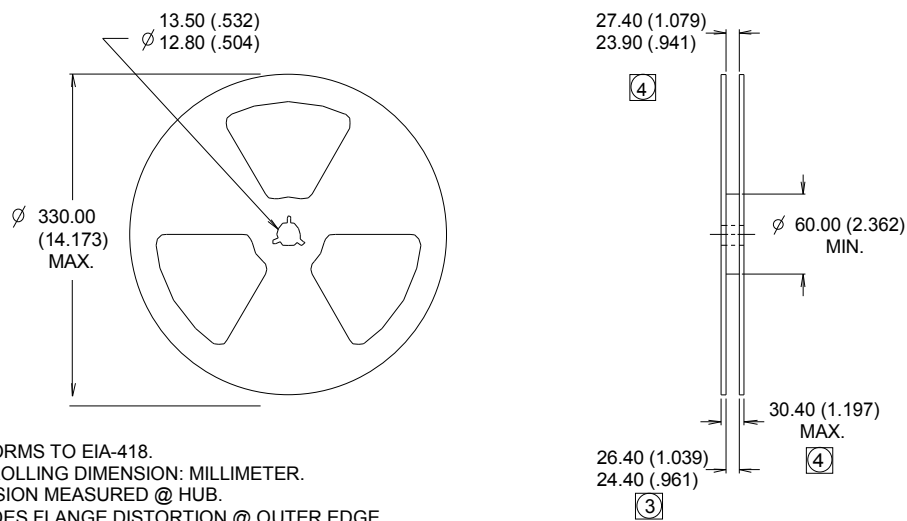
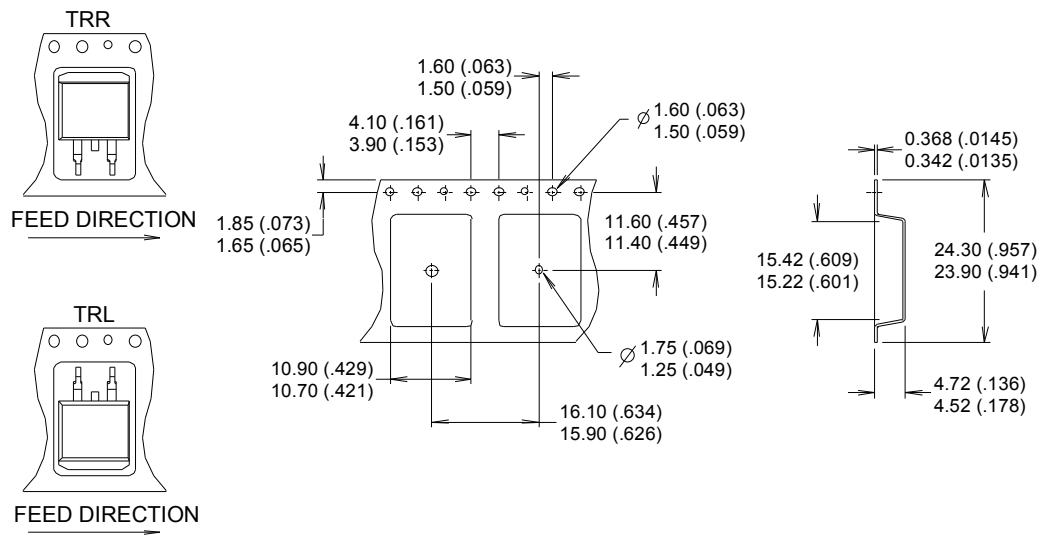

Fig 18b. Switching Time Waveforms

D²Pak (TO-263AB) Tape & Reel Information (Dimensions are shown in millimeters (inches))

- NOTES :
1. COMFORMS TO EIA-418.
 2. CONTROLLING DIMENSION: MILLIMETER.
 3. DIMENSION MEASURED @ HUB.
 4. INCLUDES FLANGE DISTORTION @ OUTER EDGE.

Note: For the most current drawing please refer to IR website at <http://www.irf.com/package/>

Qualification Information

Qualification Level		Automotive (per AEC-Q101)	
		Comments: This part number(s) passed Automotive qualification. Infineon's Industrial and Consumer qualification level is granted by extension of the higher Automotive level.	
Moisture Sensitivity Level		D ² -Pak	MSL1
ESD	Machine Model	Class M4 (+/- 600V) [†] AEC-Q101-002	
	Human Body Model	Class H1C (+/- 2000V) [†] AEC-Q101-001	
	Charged Device Model	Class C5 (+/- 2000V) [†] AEC-Q101-005	
RoHS Compliant		Yes	

† Highest passing voltage.

Revision History

Date	Comments
3/3/2014	<ul style="list-style-type: none"> Added "Logic Level Gate Drive" bullet in the features section on page 1 Updated data sheet with new IR corporate template
11/6/2015	<ul style="list-style-type: none"> Updated datasheet with corporate template Corrected ordering table on page 1.

Published by

Infineon Technologies AG
81726 München, Germany

© Infineon Technologies AG 2015

All Rights Reserved.

IMPORTANT NOTICE

The information given in this document shall in no event be regarded as a guarantee of conditions or characteristics ("Beschaffheitsgarantie"). With respect to any examples, hints or any typical values stated herein and/or any information regarding the application of the product, Infineon Technologies hereby disclaims any and all warranties and liabilities of any kind, including without limitation warranties of non-infringement of intellectual property rights of any third party.

In addition, any information given in this document is subject to customer's compliance with its obligations stated in this document and any applicable legal requirements, norms and standards concerning customer's products and any use of the product of Infineon Technologies in customer's applications.

The data contained in this document is exclusively intended for technically trained staff. It is the responsibility of customer's technical departments to evaluate the suitability of the product for the intended application and the completeness of the product information given in this document with respect to such application.

For further information on the product, technology, delivery terms and conditions and prices please contact your nearest Infineon Technologies office (www.infineon.com).

WARNINGS

Due to technical requirements products may contain dangerous substances. For information on the types in question please contact your nearest Infineon Technologies office.

Except as otherwise explicitly approved by Infineon Technologies in a written document signed by authorized representatives of Infineon Technologies, Infineon Technologies' products may not be used in any applications where a failure of the product or any consequences of the use thereof can reasonably be expected to result in personal injury.