

Field Stop IGBT

Utilizing the latest Field Stop and Trench Gate technologies, these IGBT's have ultra low $V_{CE(ON)}$ and are ideal for low frequency applications that require absolute minimum conduction loss. Easy paralleling is a result of very tight parameter distribution and a slightly positive $V_{CE(ON)}$ temperature coefficient. A built-in gate resistor ensures extremely reliable operation, even in the event of a short circuit fault. Low gate charge simplifies gate drive design and minimizes losses.

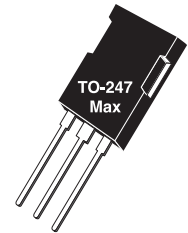

- **1200V Field Stop**
- **Trench Gate: Low $V_{CE(ON)}$**
- **Easy Paralleling**
- **Integrated Gate Resistor :Low EMI, High Reliability**
- **RoHS Compliant**

Applications: Welding, Inductive Heating, Solar Inverters, SMPS, Motor drives, UPS

Maximum Ratings

All Ratings: $T_c = 25^\circ C$ unless otherwise specified.

Symbol	Parameter	Ratings	Unit
V_{CES}	Collector-Emitter Voltage	600	Volts
V_{GE}	Gate-Emitter Voltage	± 20	
I_{C1}	Continuous Collector Current @ $T_c = 25^\circ C$	283	Amps
I_{C2}	Continuous Collector Current @ $T_c = 110^\circ C$	158	
I_{CM}	Pulsed Collector Current ^①	600	
SSOA	Switching Safe Operating Area @ $T_j = 175^\circ C$	600A @ 600V	
P_D	Total Power Dissipation	682	Watts
T_J, T_{STG}	Operating and Storage Junction Temperature Range	-55 to 175	$^\circ C$
T_L	Max. Lead Temp. for Soldering: 0.063" from Case for 10 Sec.	300	

Static Electrical Characteristics

Symbol	Characteristic / Test Conditions	Min	Typ	Max	Unit
$V_{(BR)CES}$	Collector-Emitter Breakdown Voltage ($V_{GE} = 0V, I_C = 4mA$)	600	-	-	Volts
$V_{GE(TH)}$	Gate Threshold Voltage ($V_{CE} = V_{GE}, I_C = 3.2mA, T_j = 25^\circ C$)	5.0	5.8	6.5	
$V_{CE(ON)}$	Collector Emitter On Voltage ($V_{GE} = 15V, I_C = 200A, T_j = 25^\circ C$)	1.05	1.45	1.85	
	Collector Emitter On Voltage ($V_{GE} = 15V, I_C = 200A, T_j = 125^\circ C$)	-	1.65	-	
I_{CES}	Collector Cut-off Current ($V_{CE} = 600V, V_{GE} = 0V, T_j = 25^\circ C$) ^②	-	-	25	μA
	Collector Cut-off Current ($V_{CE} = 600V, V_{GE} = 0V, T_j = 125^\circ C$) ^②	-	-	1000	
I_{GES}	Gate-Emitter Leakage Current ($V_{GE} = \pm 20V$)	-	-	600	nA
$R_{G(int)}$	Integrated Gate Resistor	-	2	-	Ω

 CAUTION: These Devices are Sensitive to Electrostatic Discharge. Proper Handling Procedures Should Be Followed.

Dynamic Characteristics

APT200GN60B2G

Symbol	Characteristic	Test Conditions	Min	Typ	Max	Unit
C_{ies}	Input Capacitance	$V_{GE} = 0V, V_{CE} = 25V$ $f = 1MHz$	-	14100	-	pF
C_{oes}	Output Capacitance		-	461	-	
C_{res}	Reverse Transfer Capacitance		-	393	-	
V_{GEP}	Gate-to-Emitter Plateau Voltage	Gate Charge $V_{GE} = 15V$ $V_{CE} = 300V$ $I_C = 100A$	-	8.2	-	V
Q_g	Total Gate Charge		-	1180	-	nC
Q_{ge}	Gate-Emitter Charge		-	85	-	
Q_{gc}	Gate-Collector Charge		-	660	-	
SSOA	Switching Safe Operating Area	$T_J = 150^\circ C, R_G = 1.0\Omega^{(2)}, V_{GE} = 15V,$ $L = 100\mu H, V_{CE} = 600V$	600			A
$t_{d(on)}$	Turn-On Delay Time	Inductive Switching ($25^\circ C$) $V_{CC} = 400V$ $V_{GE} = 15V$ $I_C = 200A$ $R_G = 1.0\Omega$ $T_J = +25^\circ C$	-	50	-	ns
t_r	Current Rise Time		-	80	-	
$t_{d(off)}$	Turn-Off Delay Time		-	560	-	
t_f	Current Fall Time		-	100	-	mJ
E_{on1}	Turn-On Switching Energy ⁽⁴⁾		-	13	-	
E_{on2}	Turn-On Switching Energy ⁽⁵⁾		-	15	-	
E_{off}	Turn-Off Switching Energy ⁽⁶⁾	-	11	-		
$t_{d(on)}$	Turn-On Delay Time	Inductive Switching ($125^\circ C$) $V_{CC} = 400V$ $V_{GE} = 15V$ $I_C = 200A$ $R_G = 1.0\Omega$ $T_J = +125^\circ C$	-	50	-	ns
t_r	Current Rise Time		-	80	-	
$t_{d(off)}$	Turn-Off Delay Time		-	620	-	
t_f	Current Fall Time		-	70	-	mJ
E_{on1}	Turn-On Switching Energy ⁽⁴⁾		-	14	-	
E_{on2}	Turn-On Switching Energy ⁽⁵⁾		-	16	-	
E_{off}	Turn-Off Switching Energy ⁽⁶⁾	-	10	-		

Thermal and Mechanical Characteristics

Symbol	Characteristic / Test Conditions	Min	Typ	Max	Unit
$R_{\theta JC}$	Junction to Case (IGBT)	-	-	0.13	$^\circ C/W$
$R_{\theta JC}$	Junction to Case (DIODE)	-	-	N/A	
W_T	Package Weight	-	6.1	-	gm

① Repetitive Rating: Pulse width limited by maximum junction temperature.

② For Combi devices, I_{ces} includes both IGBT and FRED leakages

③ See MIL-STD-750 Method 3471.

④ E_{on1} is the clamped inductive turn-on energy of the IGBT only, without the effect of a commutating diode reverse recovery current adding to the IGBT turn-on loss. Tested in inductive switching test circuit shown in figure 21, but with a Silicon Carbide diode.

⑤ E_{on2} is the clamped inductive turn-on energy that includes a commutating diode reverse recovery current in the IGBT turn-on switching loss. (See Figures 21, 22.)

⑥ E_{off} is the clamped inductive turn-off energy measured in accordance with JEDEC standard JESD24-1. (See Figures 21, 23.)

⑦ R_G is external gate resistance not including gate driver impedance.

Microsemi reserves the right to change, without notice, the specifications and information contained herein.

Typical Performance Curves

APT200GN60B2G

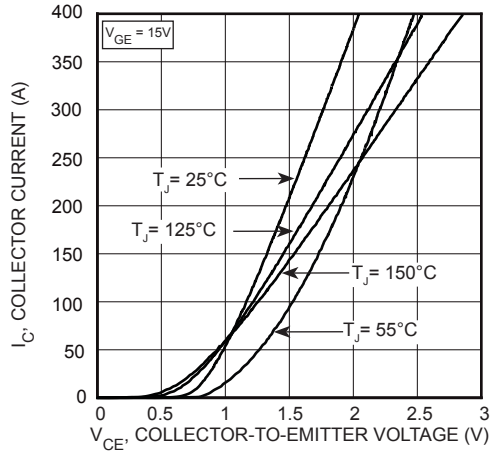

FIGURE 1, Output Characteristics ($T_J = 25^\circ\text{C}$)

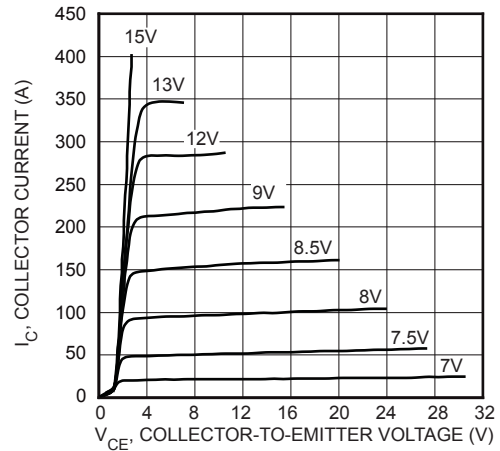

FIGURE 2, Output Characteristics ($T_J = 25^\circ\text{C}$)

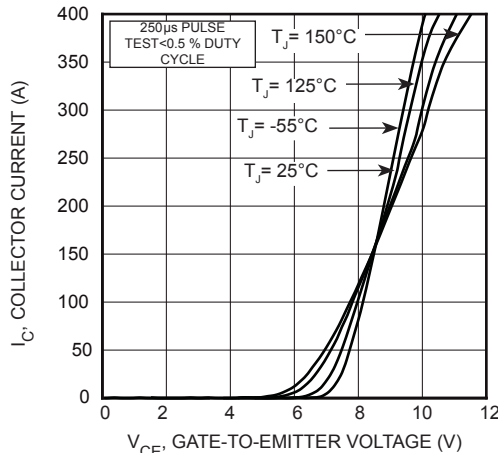

FIGURE 3, Transfer Characteristics

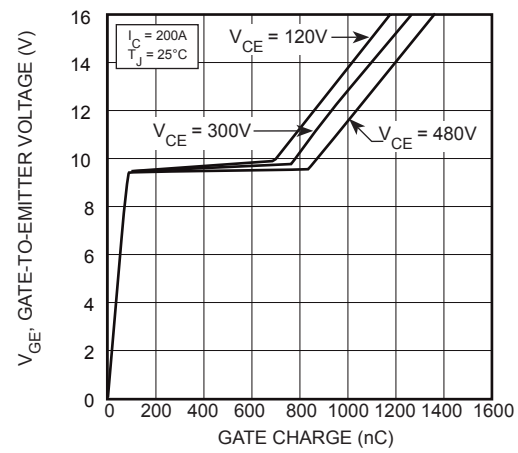

FIGURE 4, Gate charge

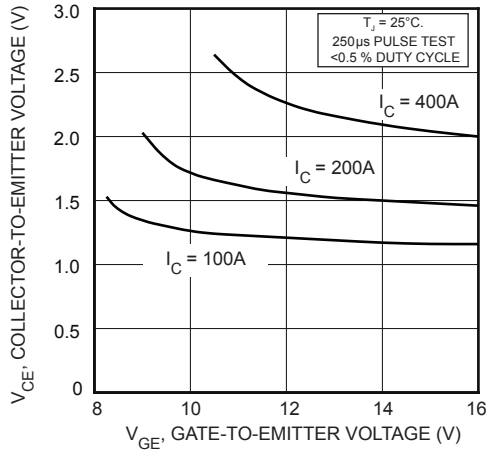

FIGURE 5, On State Voltage vs Gate-to-Emitter Voltage

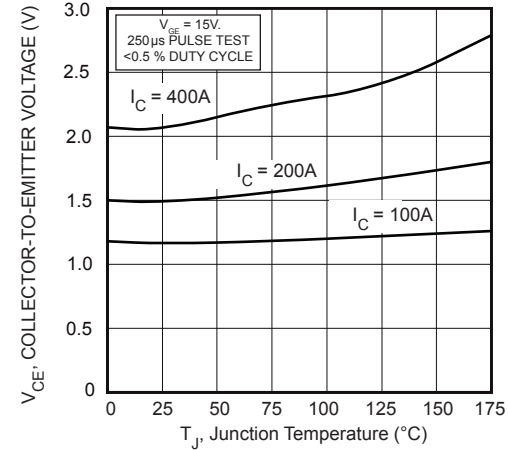

FIGURE 6, On State Voltage vs Junction Temperature

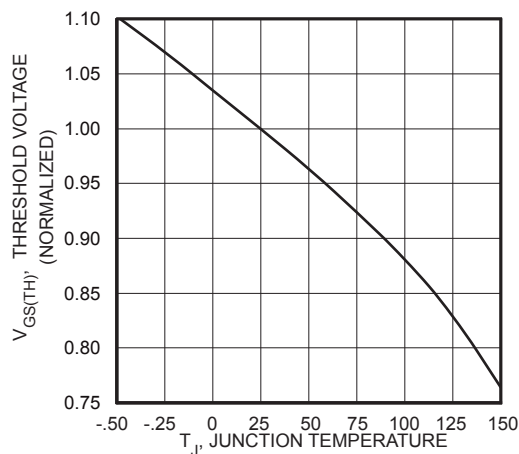

FIGURE 7, Threshold Voltage vs Junction Temperature

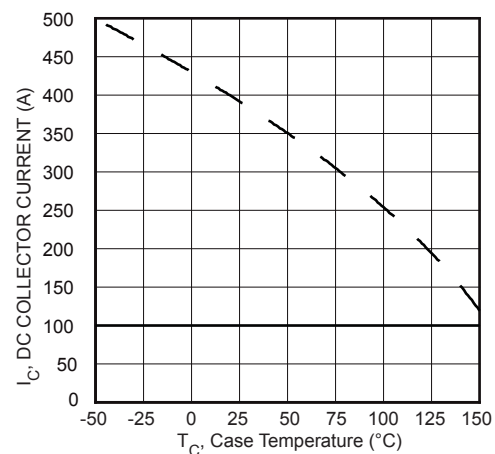

FIGURE 8, DC Collector Current vs Case Temperature

Typical Performance Curves

APT200GN60B2G

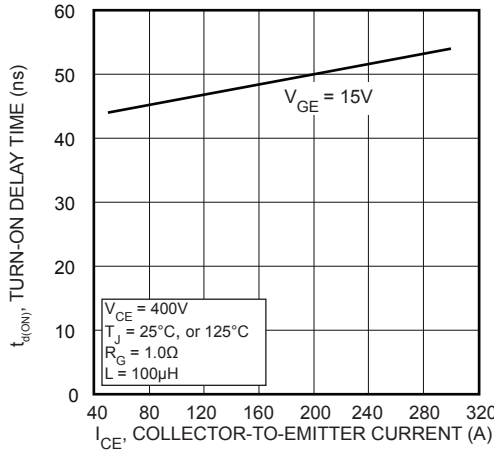

FIGURE 9, Turn-On Delay Time vs Collector Current

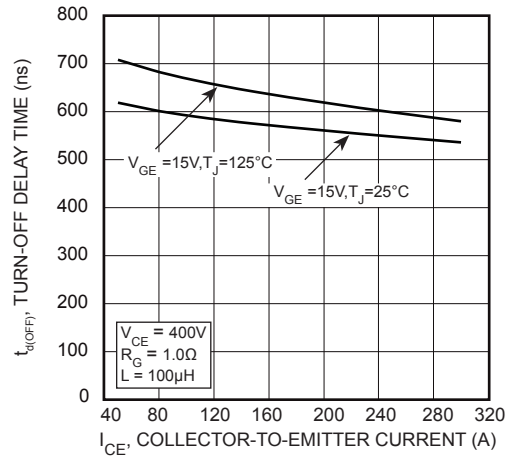

FIGURE 10, Turn-Off Delay Time vs Collector Current

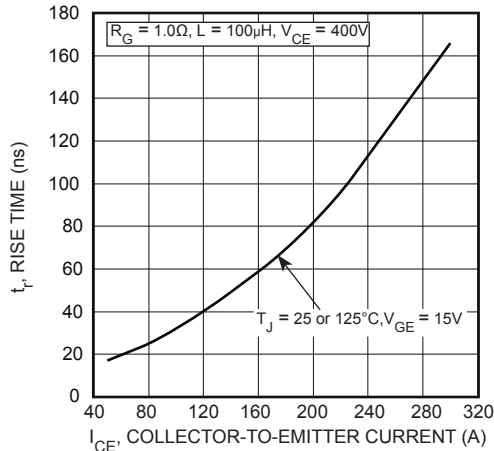

FIGURE 11, Current Rise Time vs Collector Current

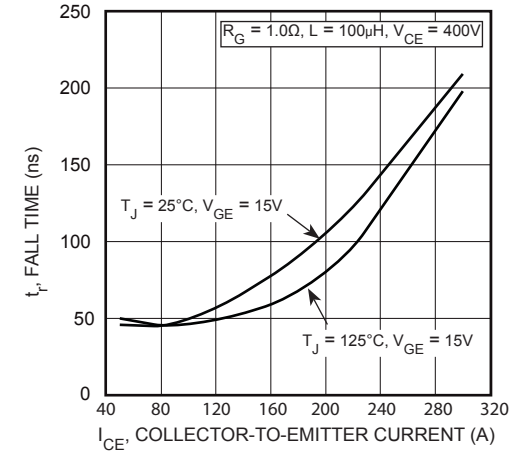

FIGURE 12, Current Fall Time vs Collector Current

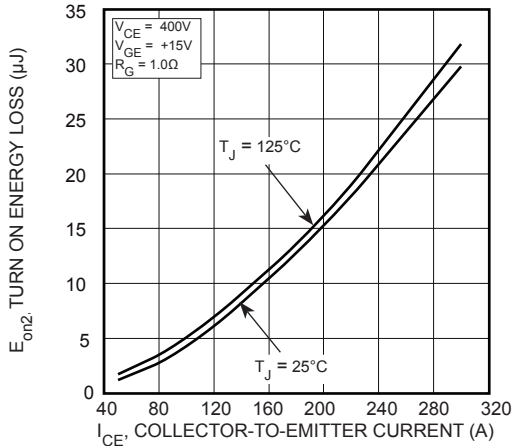

FIGURE 13, Turn-On Energy Loss vs Collector Current

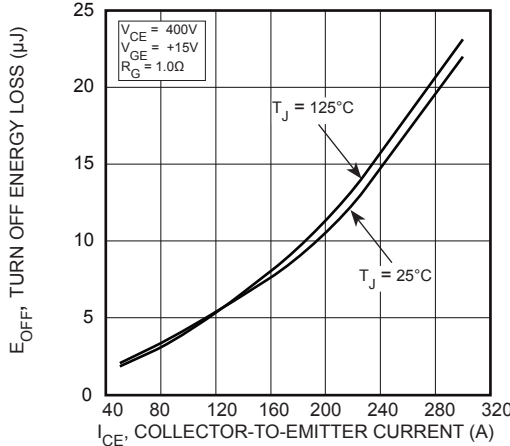

FIGURE 14, Turn-Off Energy Loss vs Collector Current

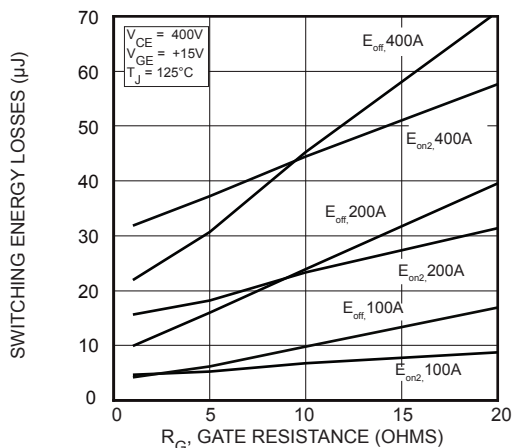

FIGURE 15, Switching Energy Losses vs Gate Resistance

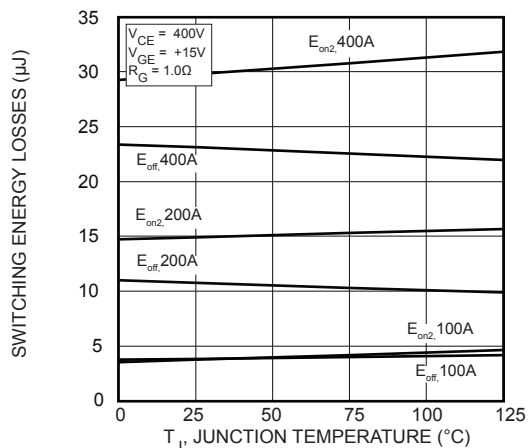

FIGURE 16, Switching Energy Losses vs Junction Temperature

Typical Performance Curves

APT200GN60B2G

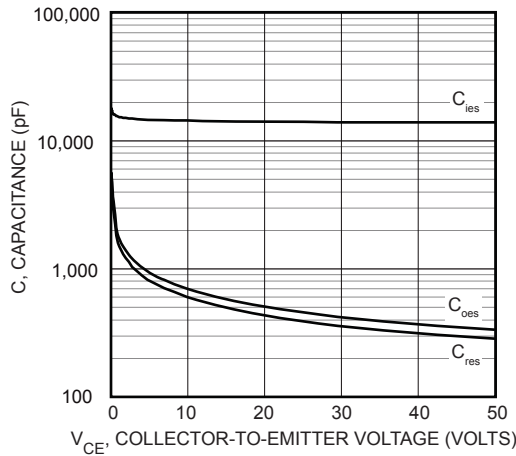

FIGURE 17, Capacitance vs Collector-To-Emitter Voltage

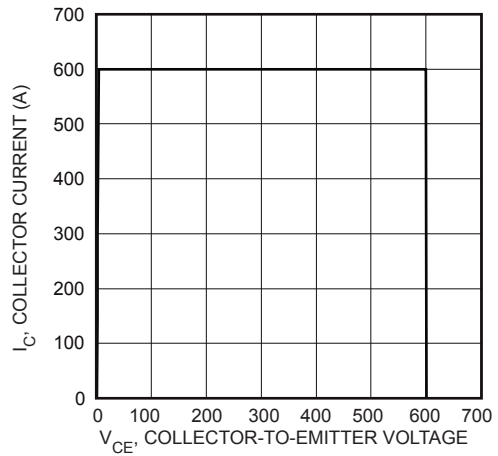

FIGURE 18, Minimum Switching Safe Operating Area

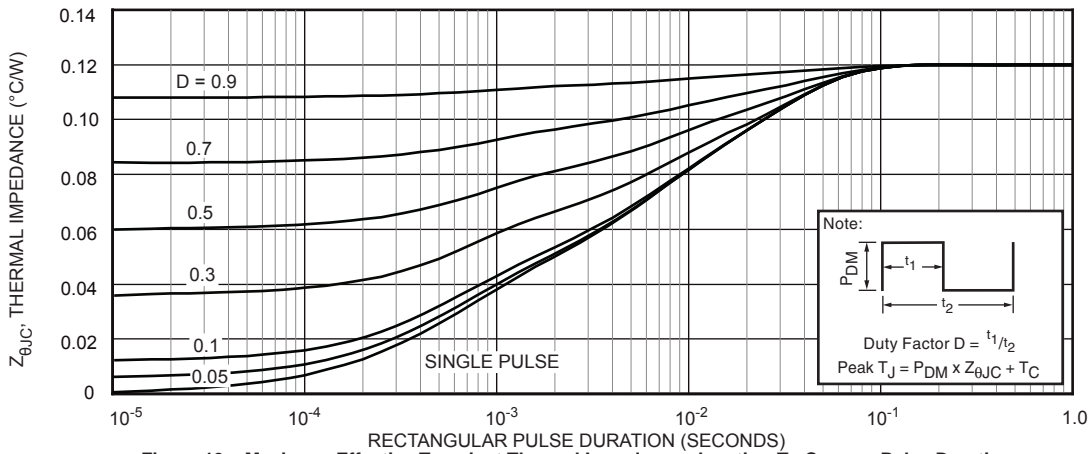

Figure 19a, Maximum Effective Transient Thermal Impedance, Junction-To-Case vs Pulse Duration

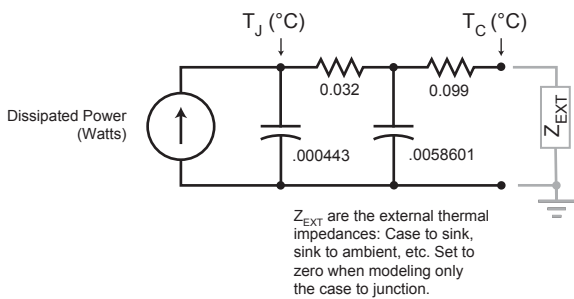

FIGURE 19b, TRANSIENT THERMAL IMPEDANCE MODEL

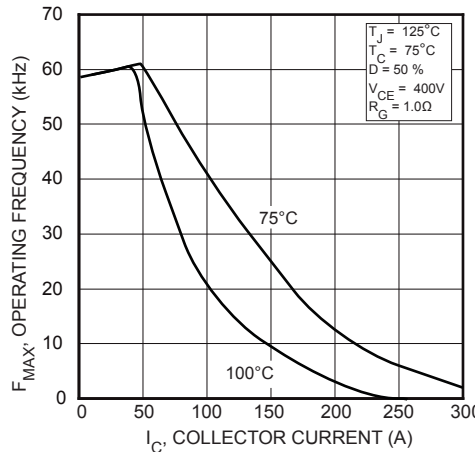

Figure 20, Operating Frequency vs Collector Current

$$f_{max} = \min(f_{max1}, f_{max2})$$

$$f_{max1} = \frac{0.05}{t_{d(on)} + t_r + t_{d(off)} + t_f}$$

$$f_{max2} = \frac{P_{diss} - P_{cond}}{E_{on2} + E_{off}}$$

$$P_{diss} = \frac{T_J - T_C}{R_{\theta JC}}$$

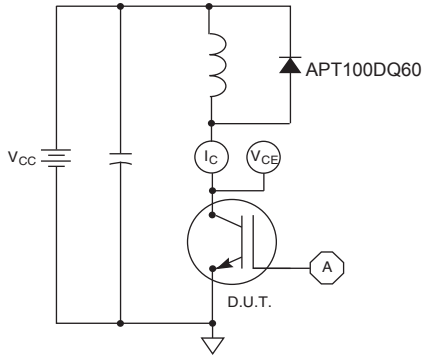

Figure 21, Inductive Switching Test Circuit

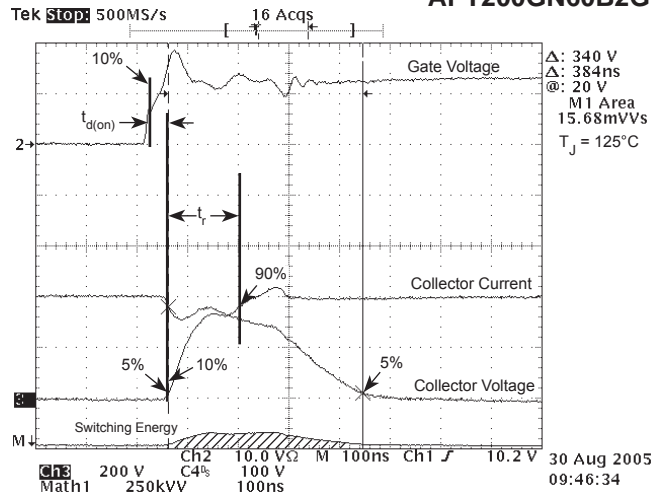

Figure 22, Turn-on Switching Waveforms and Definitions

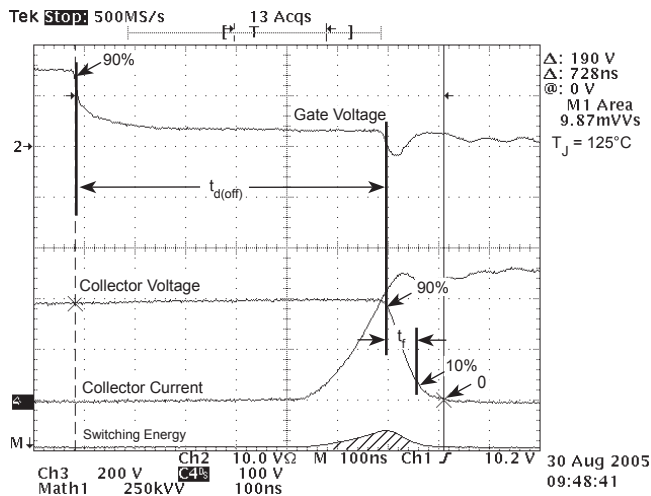
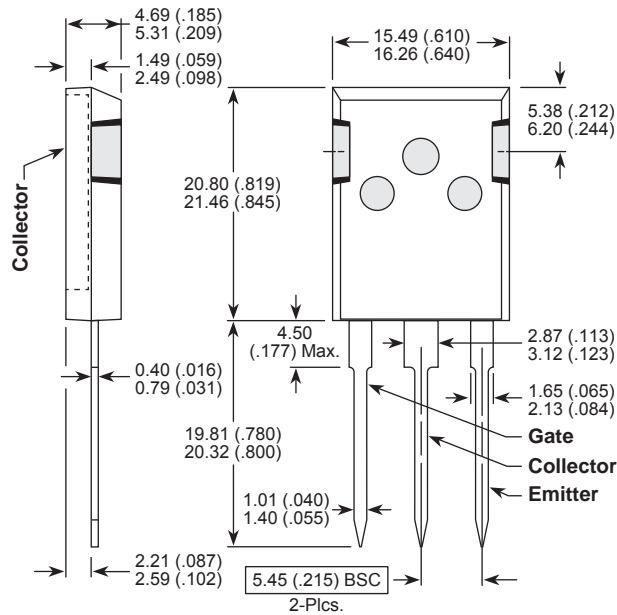

Figure 23, Turn-off Switching Waveforms and Definitions

T-MAX® Package Outline



Dimensions in Millimeters and (Inches)