

50Ω

500 to 1200 MHz



Case Style: GC957

The Big Deal

- Industry Leading High IP3, 46 dBm typ.
- Output Power at 1 dB Compression, +23 dBm
- Wideband, 500 to 1200 MHz

Product Overview

The ZX60-H122+ (RoHS compliant) uses Mini-Circuits' high dynamic MMIC technology and optimization circuits to provide industry leading linearity over a focused frequency range. Housed in a rugged, cost effective unibody chassis, this amplifier supports a wide variety of applications requiring moderate power output, low distortion and 50 ohm matched input/output ports.

Key Features

Feature	Advantages
Extreme High IP3 vs. Current 46.2 dBm typical at 900 MHz versus DC Power consumption of 145mA	The ZX60-H122+ offers industry leading IP3 performance relative to power consumption. The combination of the design and E-PHEMT provides enhanced linearity as evidence in the IP3. This feature makes this amplifier ideal for use in: <ul style="list-style-type: none"> • driver amplifiers for complex waveform upconverter paths • drivers in linearized transmit systems • secondary amplifiers in ultra high dynamic range receivers
Optimized Frequency Range	Covering primary wireless communication bands: cellular and LTE
Low Noise Figure, 2.5 dB typ.	A unique feature of the ZX60-H122+ is the combination of low noise figure performance with the high dynamic range, differentiating this amplifier from the competition.
Unconditionally Stable	Capable to operate to a wide range of source and load impedances.
Very Small Size, 0.75" x 0.75"	The unique unibody size and construction enable the ZX60-H122+ to be used in extremely compact connectorized applications.

Notes

A. Performance and quality attributes and conditions not expressly stated in this specification document are intended to be excluded and do not form a part of this specification document.

B. Electrical specifications and performance data contained in this specification document are based on Mini-Circuit's applicable established test performance criteria and measurement instructions.

C. The parts covered by this specification document are subject to Mini-Circuits standard limited warranty and terms and conditions (collectively, "Standard Terms"); Purchasers of this part are entitled to the rights and benefits contained therein. For a full statement of the Standard Terms and the exclusive rights and remedies thereunder, please visit Mini-Circuits' website at www.minicircuits.com/MCLStore/terms.jsp

Ultra High IP3 Wideband Amplifier

ZX60-H122+

50Ω 500 to 1200 MHz

Features

- Ultra High IP3, +46.2 dBm typ. at 0.9 GHz
- Gain, 14.9 dB typ. at 0.9 GHz
- High Pout, P1dB, +22.8 dBm typ. at 0.9 GHz
- Low noise figure, 2.5 dB typ. at 0.9 GHz

Applications

- LTE
- Buffer amplifier
- Test equipment
- High dynamic range lab driver amps



Case Style: GC957
Connectors Model
SMA ZX60-H122-S+

+RoHS Compliant

The +Suffix identifies RoHS Compliance. See our web site for RoHS Compliance methodologies and qualifications

Electrical Specifications at 25°C and 5.5V unless noted

Parameter	Condition (GHz)	Min.	Typ.	Max.	Units
Frequency Range		0.5		1.2	GHz
Gain	0.5		15.6		dB
	0.7		15.3		
	0.9	13.4	14.9	16.4	
	1.2		14.2		
Input Return Loss	0.5		18.4		dB
	0.7		16.9		
	0.9		14.4		
	1.2		11.2		
Output Return Loss	0.5		16.6		dB
	0.7		13.6		
	0.9		11.4		
	1.2		8.9		
Output IP3	0.5		41.9		dBm
	0.7		45.2		
	0.9	41.0	46.2		
	1.2		40.6		
Output Power @ 1 dB compression	0.5		22.3		dBm
	0.7		22.4		
	0.9		22.8		
	1.2		23.0		
Noise Figure	0.5		2.3		dB
	0.7		2.4		
	0.9		2.5		
	1.2		2.5		
Directivity (Isolation-Gain)	0.5 - 1.2		6		dB
DC Voltage		5.5	—	7.0	V
DC Current		110	145	180	mA

Notes

- A. Performance and quality attributes and conditions not expressly stated in this specification document are intended to be excluded and do not form a part of this specification document.
 B. Electrical specifications and performance data contained in this specification document are based on Mini-Circuit's applicable established test performance criteria and measurement instructions.
 C. The parts covered by this specification document are subject to Mini-Circuits standard limited warranty and terms and conditions (collectively, "Standard Terms"); Purchasers of this part are entitled to the rights and benefits contained therein. For a full statement of the Standard Terms and the exclusive rights and remedies thereunder, please visit Mini-Circuits' website at www.minicircuits.com/MCLStore/terms.jsp



Maximum Ratings

Parameter	Ratings
Operating Temperature	-40°C to 85°C Case
Storage Temperature	-55°C to 100°C
DC Voltage	7 V
Input RF Power (no damage)	24 dBm
Power Consumption	1.25 W

Permanent damage may occur if any of these limits are exceeded.

Outline Drawing

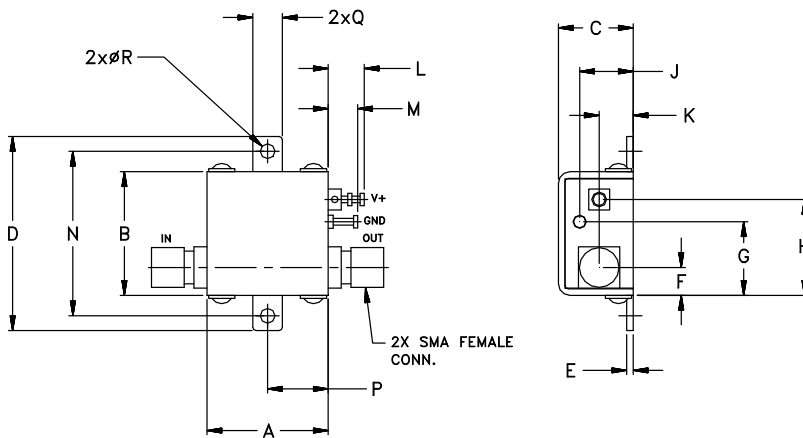

! NOTE: When soldering the DC connections, caution must be used to avoid overheating the DC terminal. See Application Note. [AN-40-010](#).

Outline Dimensions (inch mm)

A	B	C	D	E	F	G	H	J	K	L	M	N	P	Q	R	wt
.74	.75	.46	1.18	.04	.17	.45	.59	.33	.21	.22	.18	1.00	.37	.18	.106	grams
18.80	19.05	11.68	29.97	1.02	4.32	11.43	14.99	8.38	5.33	5.59	4.57	25.40	9.40	4.57	2.69	23.0

Notes

- Performance and quality attributes and conditions not expressly stated in this specification document are intended to be excluded and do not form a part of this specification document.
- Electrical specifications and performance data contained in this specification document are based on Mini-Circuit's applicable established test performance criteria and measurement instructions.
- The parts covered by this specification document are subject to Mini-Circuits standard limited warranty and terms and conditions (collectively, "Standard Terms"); Purchasers of this part are entitled to the rights and benefits contained therein. For a full statement of the Standard Terms and the exclusive rights and remedies thereunder, please visit Mini-Circuits' website at www.minicircuits.com/MCLStore/terms.jsp



FREQUENCY (MHz)	GAIN (dB)	DIRECTIVITY (dB)	VSWR (:1)		POUT at 1dB COMPR. (dBm)	NOISE FIGURE (dB)	OUTPUT IP3 (dBm)
			IN	OUT			
500.00	15.58	5.44	1.21	1.34	22.3	2.3	41.9
550.00	15.53	5.45	1.22	1.37	22.0	2.3	41.3
600.00	15.46	5.53	1.23	1.41	22.1	2.4	42.2
650.00	15.39	5.64	1.25	1.46	22.4	2.4	44.2
700.00	15.31	5.74	1.28	1.50	22.4	2.4	45.2
725.00	15.26	5.82	1.29	1.52	22.6	2.4	46.1
750.00	15.20	5.89	1.31	1.54	22.7	2.4	46.5
800.00	15.09	6.03	1.34	1.58	22.8	2.4	46.7
850.00	14.99	6.16	1.38	1.63	22.8	2.5	46.7
900.00	14.91	6.22	1.42	1.68	22.8	2.5	46.2
950.00	14.83	6.31	1.45	1.74	23.2	2.5	42.7
1000.00	14.72	6.43	1.49	1.80	23.3	2.5	41.4
1050.00	14.62	6.54	1.53	1.86	23.3	2.5	42.4
1100.00	14.49	6.70	1.58	1.92	23.3	2.5	41.6
1150.00	14.36	6.85	1.63	1.98	23.1	2.5	40.3
1200.00	14.22	7.02	1.68	2.06	23.0	2.5	40.6

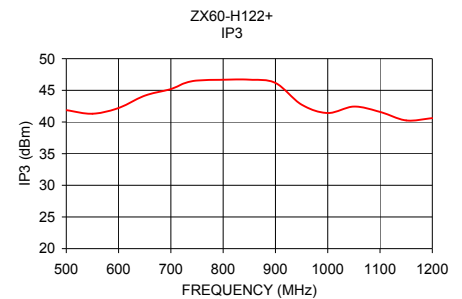
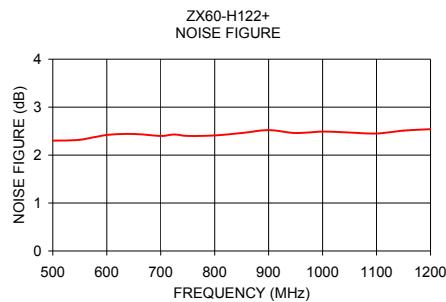
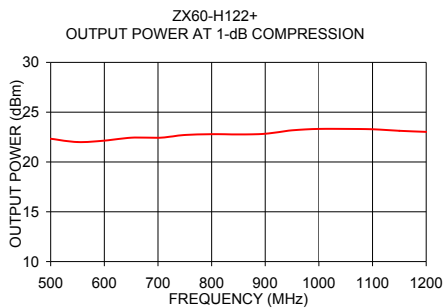
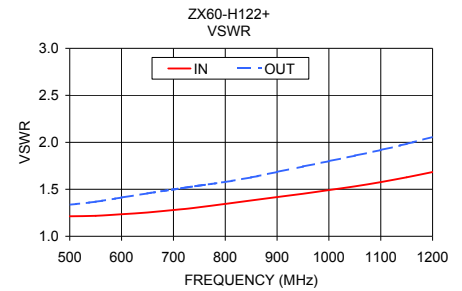
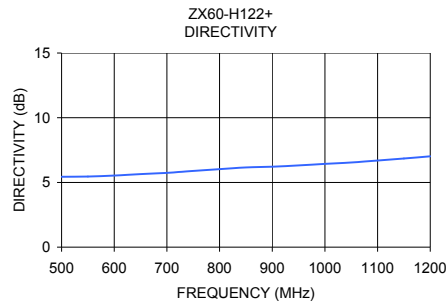
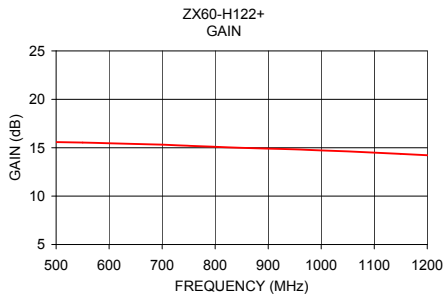

Notes

- A. Performance and quality attributes and conditions not expressly stated in this specification document are intended to be excluded and do not form a part of this specification document.
- B. Electrical specifications and performance data contained in this specification document are based on Mini-Circuits' applicable established test performance criteria and measurement instructions.
- C. The parts covered by this specification document are subject to Mini-Circuits standard limited warranty and terms and conditions (collectively, "Standard Terms"); Purchasers of this part are entitled to the rights and benefits contained therein. For a full statement of the Standard Terms and the exclusive rights and remedies thereunder, please visit Mini-Circuits' website at www.minicircuits.com/MCLStore/terms.jsp

