

# Connectorized Amplifier

## ZX60-6013E+

50Ω 20 MHz to 6 GHz

### Features

- Wide Bandwidth, 20 MHz to 6 GHz
- Low Noise Figure, 3.3 dB Typ.
- Protected by US Patent 6,790,049

### Applications

- Buffer Amplifier
- Cellular
- PCS
- Lab
- Instrumentation
- Test Equipment



CASE STYLE: GC957

Connectors	Model
SMA	ZX60-6013E-S+

#### +RoHS Compliant

The +Suffix identifies RoHS Compliance. See our web site for RoHS Compliance methodologies and qualifications

### Electrical Specifications at T<sub>AMB</sub> = 25°C

MODEL NO.	FREQ. (GHz) f <sub>L</sub> - f <sub>U</sub>	DC VOLTAGE @ Pin V+ (V)	GAIN over frequency in GHz Typ (dB)								MAXIMUM POWER (dBm) Output (1 dB Comp.) Typ. f <sub>L</sub> f <sub>U</sub>		DYNAMIC RANGE NF (dB) (dBm) Typ. IP3 (dBm) Typ.		VSWR (:1) Typ. In Out f <sub>L</sub> -3 3-f <sub>U</sub> f <sub>L</sub> -3 3-f <sub>U</sub> GHz GHz GHz GHz				ACTIVE DIRECTIVITY (dB) Isolation-Gain Typ.		DC OPERATING CURRENT @ Pin V+ (mA) Typ. Max.	
			0.1	1.0	2.0	3.0	4.0	5.0	6.0	Min.at 2 GHz	3.3	28.7	1.4	1.6	1.2	1.2	3-9	39	50			
			16.2	15.9	15.2	14.3	13.4	12.7	12.1	13.0	13.4	5.8	3.3	28.7	1.4	1.6	1.2	1.2	3-9	39	50	
ZX60-6013E+	0.02-6	12.0	16.2	15.9	15.2	14.3	13.4	12.7	12.1	13.0	13.4	5.8	3.3	28.7	1.4	1.6	1.2	1.2	3-9	39	50	

### Maximum Ratings

Operating Temperature	-45°C to 80°C case
Storage Temperature	-55°C to 100°C
DC Voltage	12.5V
Input Power(no Damage)	15dBm
Power	650mW

Permanent damage may occur if any of these limits are exceeded.



NOTE: When soldering the DC connections, caution must be used to avoid overheating the DC terminals. See Application Note [AN-40-10](#).

### Outline Drawing

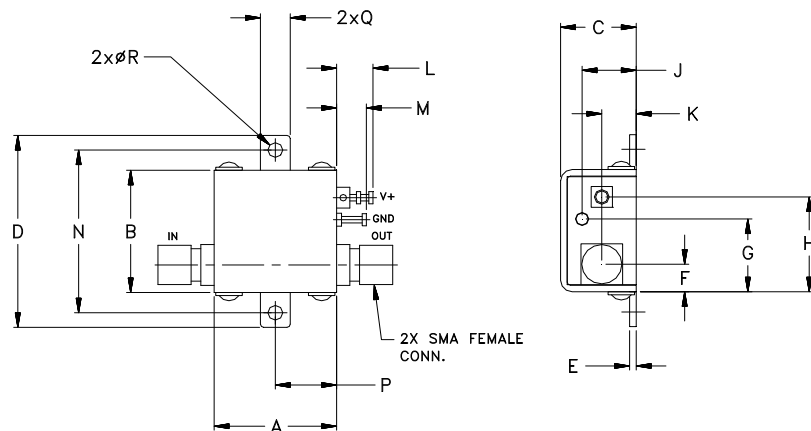

### Outline Dimensions (inch/mm)

A	B	C	D	E	F	G	H	J	K	L	M	N	P	Q	R	WT.
.74	.75	.46	1.18	.04	.17	.45	.59	.33	.21	.22	.18	1.00	.37	.18	.106	GRAM
18.80	19.05	11.68	29.97	1.02	4.32	11.43	14.99	8.38	5.33	5.59	4.57	25.40	9.40	4.57	2.69	23.0

#### Notes

- Performance and quality attributes and conditions not expressly stated in this specification document are intended to be excluded and do not form a part of this specification document.
- Electrical specifications and performance data contained in this specification document are based on Mini-Circuit's applicable established test performance criteria and measurement instructions.
- The parts covered by this specification document are subject to Mini-Circuits standard limited warranty and terms and conditions (collectively, "Standard Terms"); Purchasers of this part are entitled to the rights and benefits contained therein. For a full statement of the Standard Terms and the exclusive rights and remedies thereunder, please visit Mini-Circuits' website at [www.minicircuits.com/MCLStore/terms.jsp](http://www.minicircuits.com/MCLStore/terms.jsp)



[www.minicircuits.com](http://www.minicircuits.com) P.O. Box 350166, Brooklyn, NY 11235-0003 (718) 934-4500 sales@minicircuits.com

# Typical Performance Data & Curves at 25°C

# ZX60-6013E+

FREQUENCY (MHz)	GAIN (dB)	DIRECTIVITY (dB)	VSWR IN (:1)	VSWR OUT (:1)	POWER OUT @1dB COMPRESSION (dBm)	IP3 (dBm)	NF (dB)
20	16.09	3.60	1.24	1.03	13.24	29.97	3.33
50	16.28	3.33	1.21	1.08	13.28	29.96	3.27
100	16.31	3.24	1.20	1.10	13.35	29.95	3.20
500	16.20	3.40	1.22	1.11	13.61	29.73	3.26
1000	15.94	3.73	1.27	1.12	13.50	29.20	3.16
1500	15.60	4.12	1.38	1.14	13.22	28.42	3.27
2000	15.22	4.54	1.48	1.18	12.87	27.42	3.35
2500	14.76	5.59	1.57	1.21	12.45	26.23	3.20
3000	14.24	6.08	1.59	1.22	11.90	24.91	3.11
3220	14.11	6.22	1.57	1.25	11.60	24.28	3.32
3500	13.85	6.78	1.54	1.22	11.16	23.48	3.42
3670	13.72	6.91	1.55	1.22	10.86	22.97	3.36
3850	13.52	7.28	1.53	1.23	10.51	22.43	3.25
4000	13.37	7.13	1.51	1.22	10.21	21.98	3.21
4200	13.15	7.35	1.69	1.15	9.78	21.37	3.10
4500	13.05	7.95	1.68	1.13	9.10	20.45	3.04
5000	12.62	8.79	1.60	1.05	7.93	18.92	3.16
5500	12.33	8.81	1.51	1.07	6.81	17.44	3.19
5750	12.18	9.27	1.45	1.12	6.30	16.72	3.22
6000	12.06	9.18	1.39	1.19	5.81	16.04	3.21

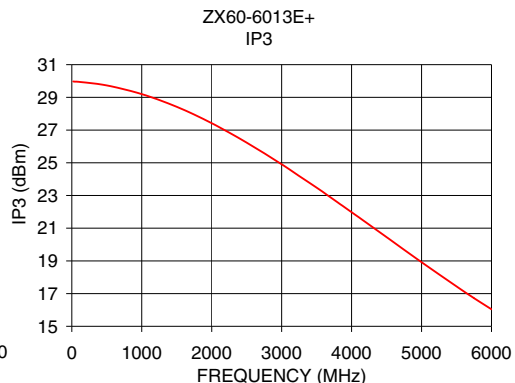
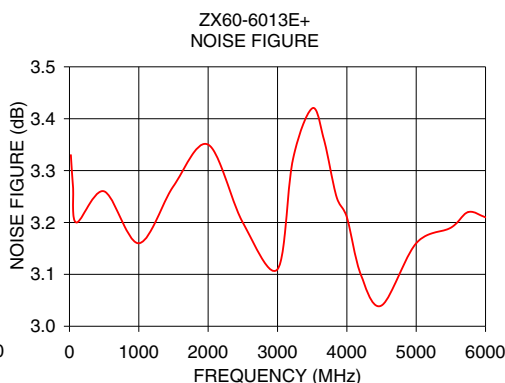
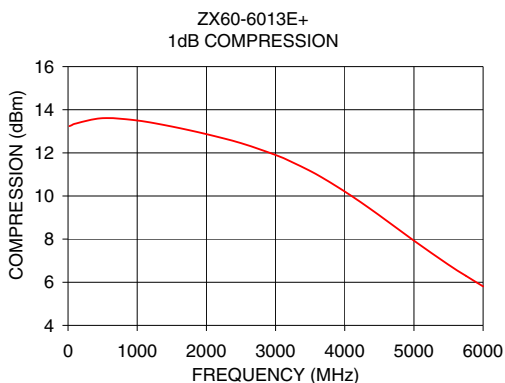
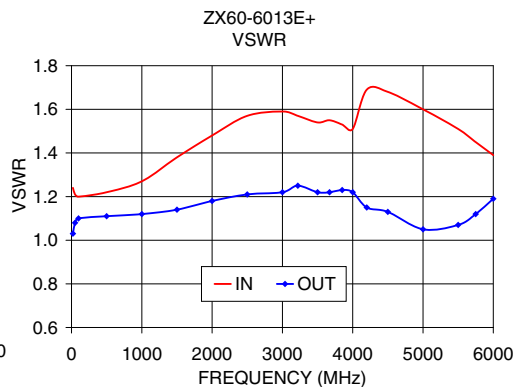
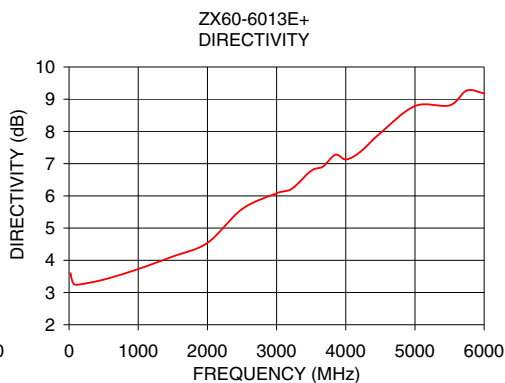
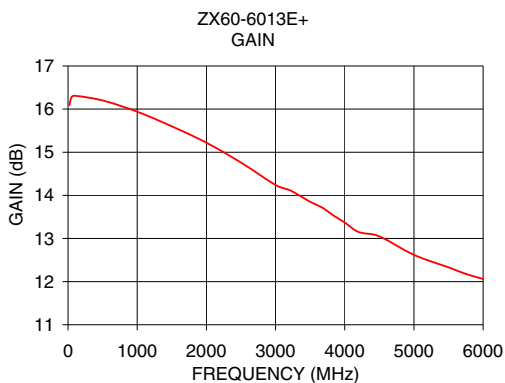

**Notes**

- A. Performance and quality attributes and conditions not expressly stated in this specification document are intended to be excluded and do not form a part of this specification document.
- B. Electrical specifications and performance data contained in this specification document are based on Mini-Circuit's applicable established test performance criteria and measurement instructions.
- C. The parts covered by this specification document are subject to Mini-Circuits standard limited warranty and terms and conditions (collectively, "Standard Terms"); Purchasers of this part are entitled to the rights and benefits contained therein. For a full statement of the Standard Terms and the exclusive rights and remedies thereunder, please visit Mini-Circuits' website at [www.minicircuits.com/MCLStore/terms.jsp](http://www.minicircuits.com/MCLStore/terms.jsp)

