

P-channel 30 V, 0.048 Ω typ., 5 A STripFET™ H6 DeepGATE™ Power MOSFET in an SO-8 package

Datasheet - preliminary data

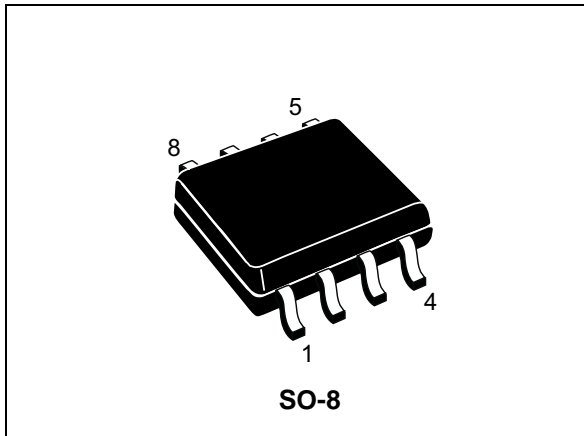
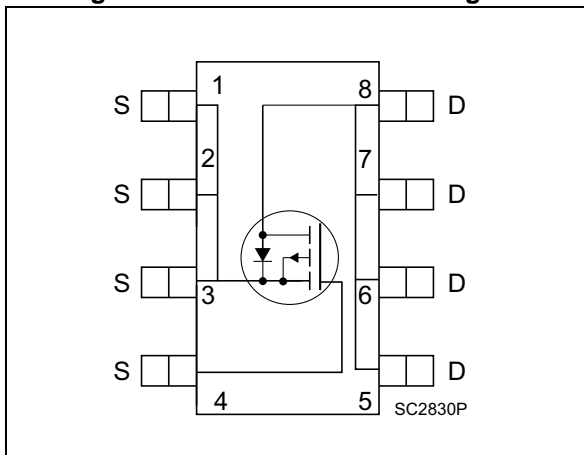

Figure 1. Internal schematic diagram



Features

Order code	V _{DS}	R _{DS(on)} max	I _D
STS5P3LLH6	30 V	0.056 Ω at 10 V	5 A

- Very low on-resistance R_{DS(on)}
- Very low gate charge
- High avalanche ruggedness
- Low gate drive power loss

Applications

- Switching applications

Description

This device is a P-channel Power MOSFET developed using the STripFET™ H6 technology with a new trench gate structure. The resulting Power MOSFET exhibits very low R_{DS(on)} in all packages.

Table 1. Device summary

Order code	Marking	Package	Packaging
STS5P3LLH6	5K3L	SO-8	Tape and reel

Note: For the P-channel MOSFET actual polarity of voltages and current has to be reversed.

Contents

1	Electrical ratings	3
2	Electrical characteristics	4
	2.1 Electrical characteristics (curves)	6
3	Test circuits	8
4	Package mechanical data	9
5	Packaging mechanical data	12
6	Revision history	14

1 Electrical ratings

Table 2. Absolute maximum ratings

Symbol	Parameter	Value	Unit
V_{DS}	Drain-source voltage	30	V
V_{GS}	Gate-source voltage	± 20	V
I_D	Drain current (continuous) at $T_{amb} = 25\text{ }^\circ\text{C}$	5	A
I_D	Drain current (continuous) at $T_{amb} = 100\text{ }^\circ\text{C}$	3.2	A
$I_{DM}^{(1)}$	Drain current (pulsed)	20	A
P_{TOT}	Total dissipation at $T_{amb} = 25\text{ }^\circ\text{C}$	2.7	W
T_J	Operating junction temperature	150	$^\circ\text{C}$
T_{stg}	Storage temperature	-55 to 150	$^\circ\text{C}$

1. Pulse width limited by safe operating area

Table 3. Thermal data

Symbol	Parameter	Value	Unit
$R_{thj-amb}^{(1)}$	Thermal resistance junction-amb	47	$^\circ\text{C/W}$

1. When mounted on 1 inch² FR-4 board, 2 oz. Cu., $t \leq 10\text{ sec}$

Note: For the P-channel Power MOSFET the actual polarity of the voltages and the current must be reversed.

2 Electrical characteristics

($T_{CASE} = 25\text{ °C}$ unless otherwise specified)

Table 4. On/off states

Symbol	Parameter	Test conditions	Min	Typ	Max	Unit
$V_{(BR)DSS}$	Drain-source breakdown voltage	$V_{GS} = 0\text{ V}, I_D = 250\text{ }\mu\text{A}$	30			V
I_{DSS}	Zero gate voltage drain current	$V_{GS} = 0\text{ V}, V_{DS} = 30\text{ V},$			1	μA
		$V_{GS} = 0\text{ V}, V_{DS} = 30\text{ V},$ $T_J = 125\text{ °C}$			10	
I_{GSS}	Gate body leakage current	$V_{DS} = 0, V_{GS} = \pm 20\text{ V}$			100	nA
$V_{GS(th)}$	Gate threshold voltage	$V_{DS} = V_{GS}, I_D = 250\text{ }\mu\text{A}$	1		2.5	V
$R_{DS(on)}$	Static drain-source on-resistance	$V_{GS} = 10\text{ V}, I_D = 2.5\text{ A}$		0.048	0.056	Ω
		$V_{GS} = 4.5\text{ V}, I_D = 2.5\text{ A}$		0.075	0.09	

Table 5. Dynamic

Symbol	Parameter	Test conditions	Min	Typ	Max	Unit
C_{iss}	Input capacitance	$V_{DS} = 25\text{ V}, f = 1\text{ MHz}$ $V_{GS} = 0$	-	639	-	μF
C_{oss}	Output capacitance		-	79	-	
C_{rss}	Reverse transfer capacitance		-	52	-	
Q_g	Total gate charge	$V_{DD} = 15\text{ V}, I_D = 5\text{ A}$ $V_{GS} = 4.5\text{ V}$	-	6	-	nC
Q_{gs}	Gate-source charge		-	1.9	-	
Q_{gd}	Gate-drain charge		-	2.1	-	

Table 6. Switching times

Symbol	Parameter	Test conditions	Min	Typ	Max	Unit
$t_{d(on)}$	Turn-on delay time	$V_{DD} = 15\text{ V}, I_D = 5\text{ A},$ $R_G = 4.7\text{ }\Omega, V_{GS} = 10\text{ V}$	-	5.4	-	ns
t_r	Rise time		-	5	-	
$t_{d(off)}$	Turn-off delay time		-	19.2	-	
t_f	Fall time		-	3.4	-	

Table 7. Source drain diode

Symbol	Parameter	Test conditions	Min	Typ	Max	Unit
$V_{SD}^{(1)}$	Forward on voltage	$I_{SD} = 5 \text{ A}$, $V_{GS} = 0$	-		1.1	V
t_{rr}	Reverse recovery time	$I_{SD} = 5 \text{ A}$, $di/dt = 100 \text{ A}/\mu\text{s}$, $V_{DD} = 16 \text{ V}$, $T_J = 150 \text{ }^\circ\text{C}$	-	11.2		ns
Q_{rr}	Reverse recovery charge		-	3.5		nC
I_{RRM}	Reverse recovery current		-	0.6		A

1. Pulsed: pulse duration=300 μs , duty cycle 1.5%

Note: For the P-channel MOSFET the actual polarity of the voltages and the current must be reversed.

2.1 Electrical characteristics (curves)

Figure 2. Safe operating area

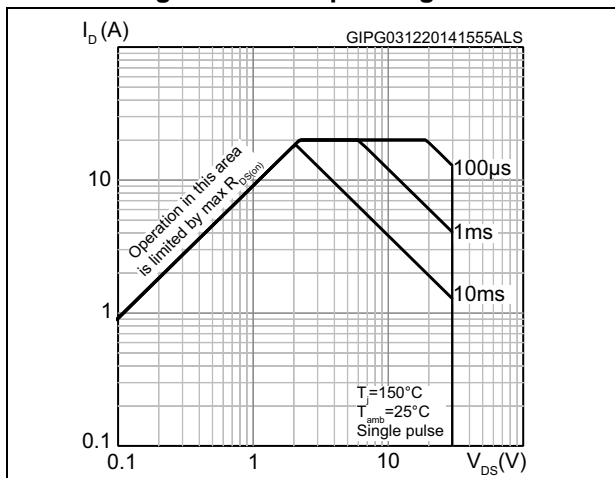

Figure 3. Thermal impedance

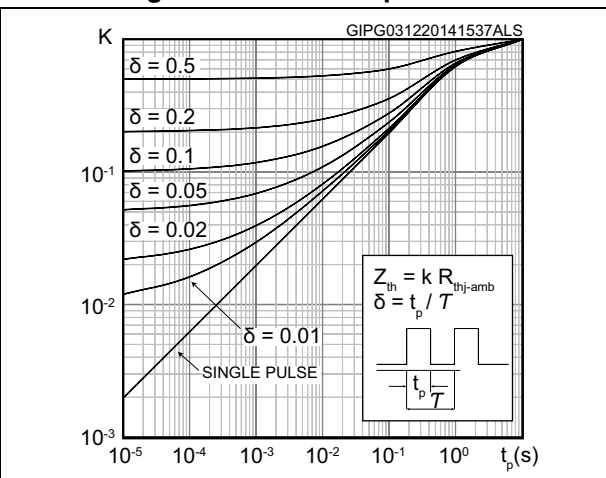

Figure 4. Output characteristics

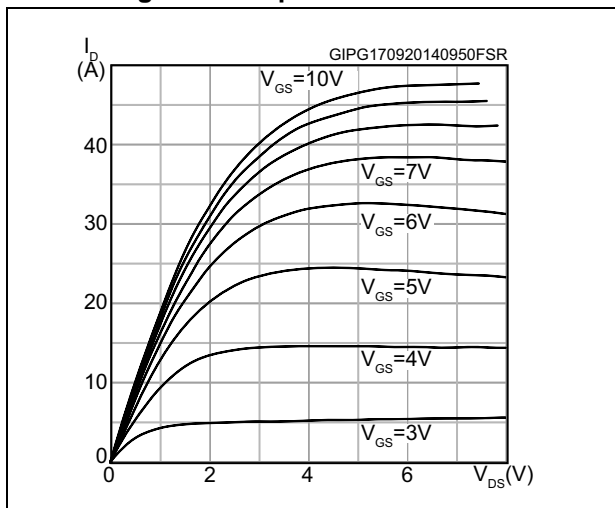

Figure 5. Transfer characteristics

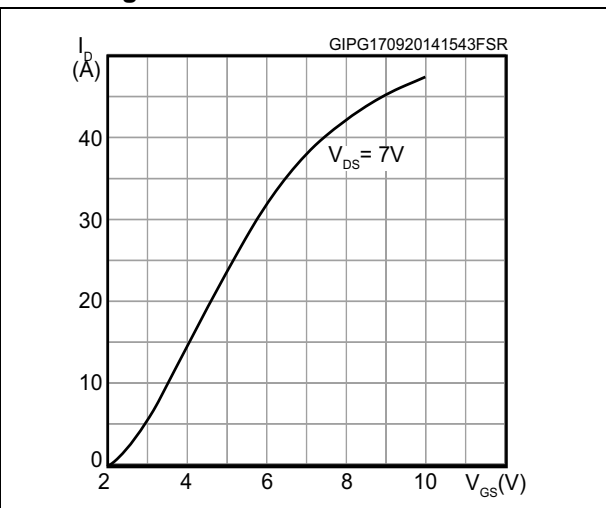

Figure 6. Gate charge vs gate-source voltage

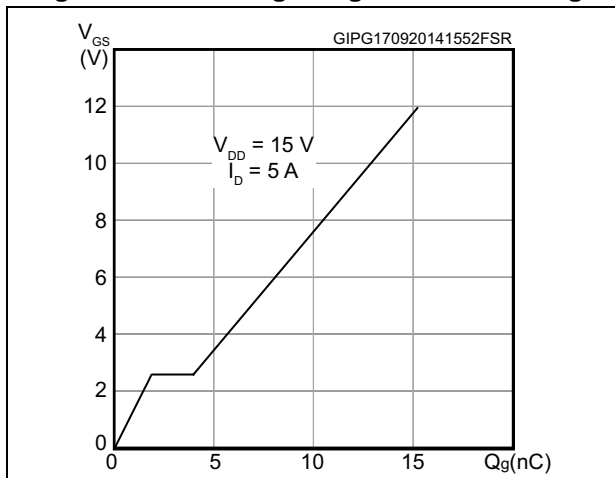

Figure 7. Static drain-source on-resistance

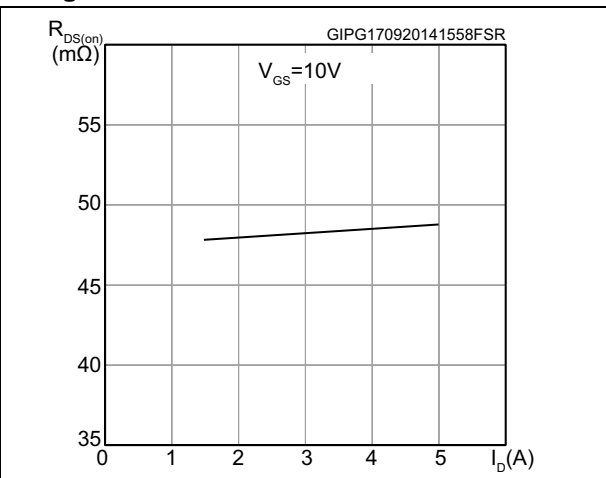

Figure 8. Normalized $V_{(BR)DSS}$ vs temperature

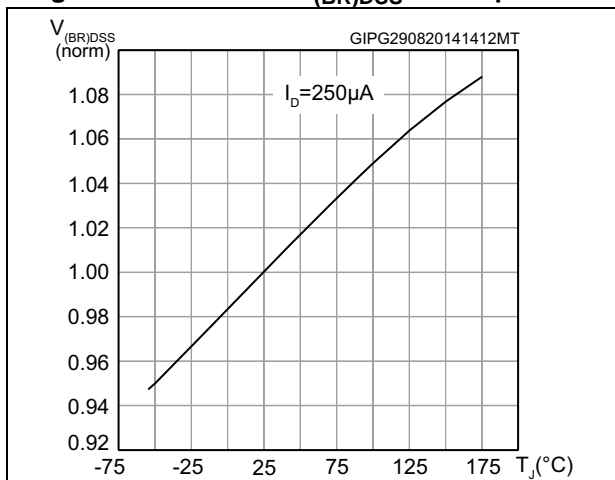

Figure 9. Capacitance variations

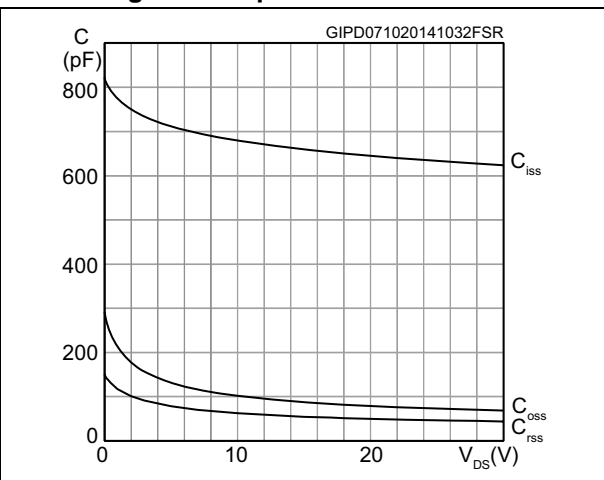

Figure 10. Normalized gate threshold voltage vs. temperature

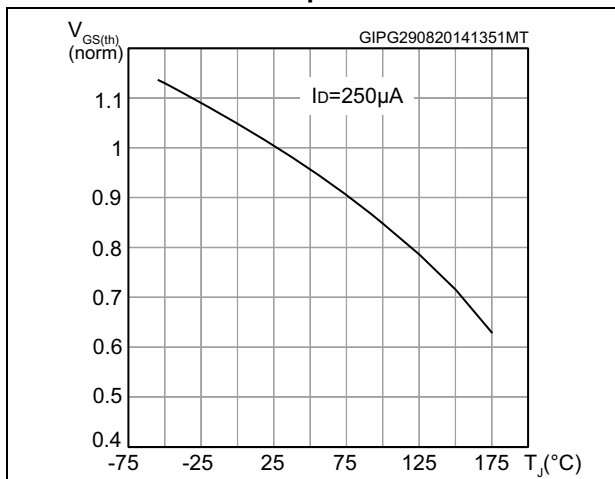

Figure 11. Normalized on-resistance vs. temperature

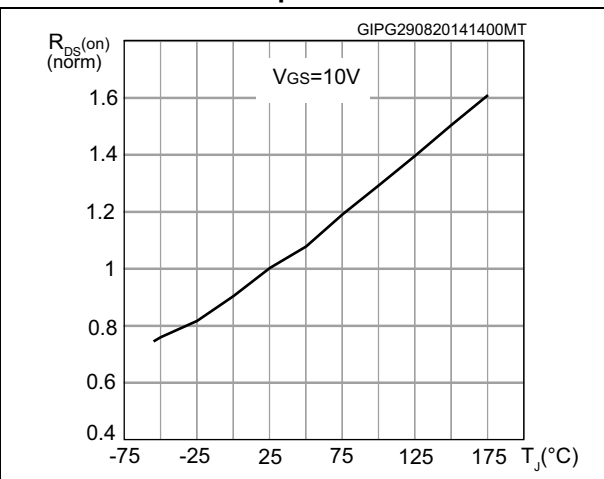
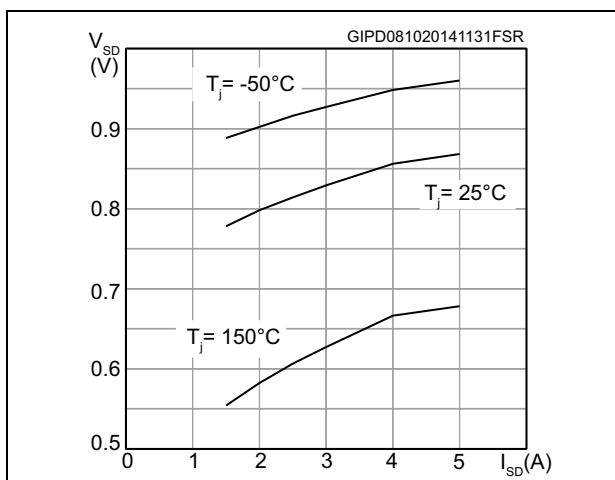

Figure 12. Source-drain diode forward characteristics



3 Test circuits

Figure 13. Switching times test circuit for resistive load

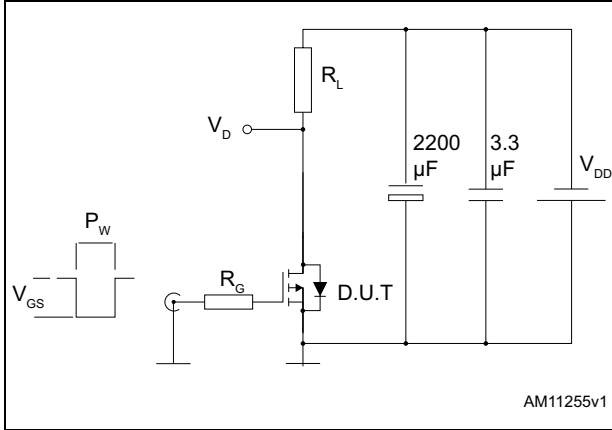

Figure 14. Gate charge test circuit

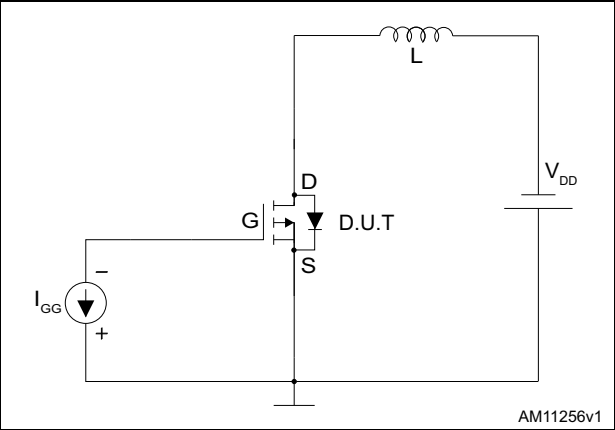
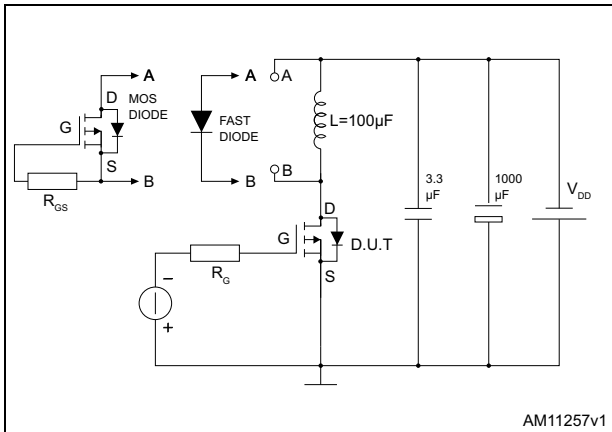

Figure 15. Test circuit for inductive load switching and diode recovery times



4 Package mechanical data

In order to meet environmental requirements, ST offers these devices in different grades of ECOPACK® packages, depending on their level of environmental compliance. ECOPACK® specifications, grade definitions and product status are available at: www.st.com. ECOPACK® is an ST trademark.

Figure 16. SO-8 drawing

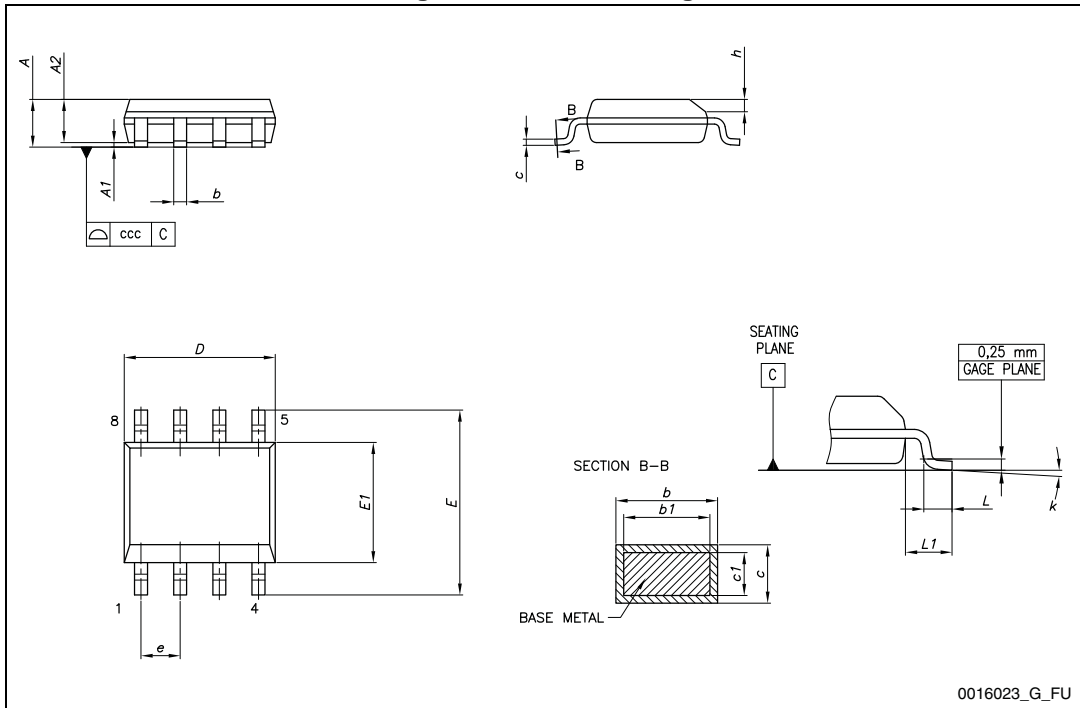
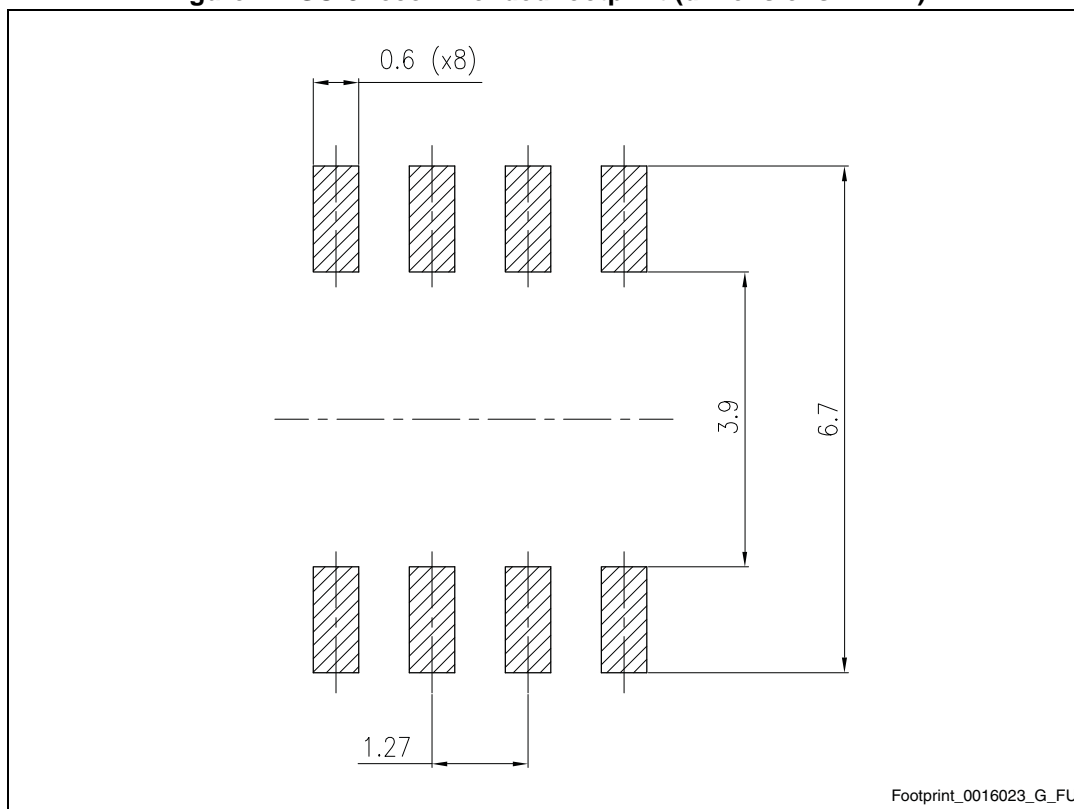

Table 8. SO-8 mechanical data

Dim.	mm		
	Min.	Typ.	Max.
A			1.75
A1	0.10		0.25
A2	1.25		
b	0.31		0.51
b1	0.28		0.48
c	0.10		0.25
c1	0.10		0.23
D	4.80	4.90	5.00
E	5.80	6.00	6.20
E1	3.80	3.90	4.00
e		1.27	
h	0.25		0.50
L	0.40		1.27
L1		1.04	
L2		0.25	
k	0°		8°
ccc			0.10

Figure 17. SO-8 recommended footprint (dimensions in mm)



5 Packaging mechanical data

Table 9. SO-8 tape and reel mechanical data

Dim	mm		
	Min	Typ	Max
A			330
C	12.8		13.2
D	20.2		
N	60		
T			22.4
Ao	8.1		8.5
Bo	5.5		5.9
Ko	2.1		2.3
Po	3.9		4.1
P	7.9		8.1

Figure 18. SO-8 tape and reel dimensions

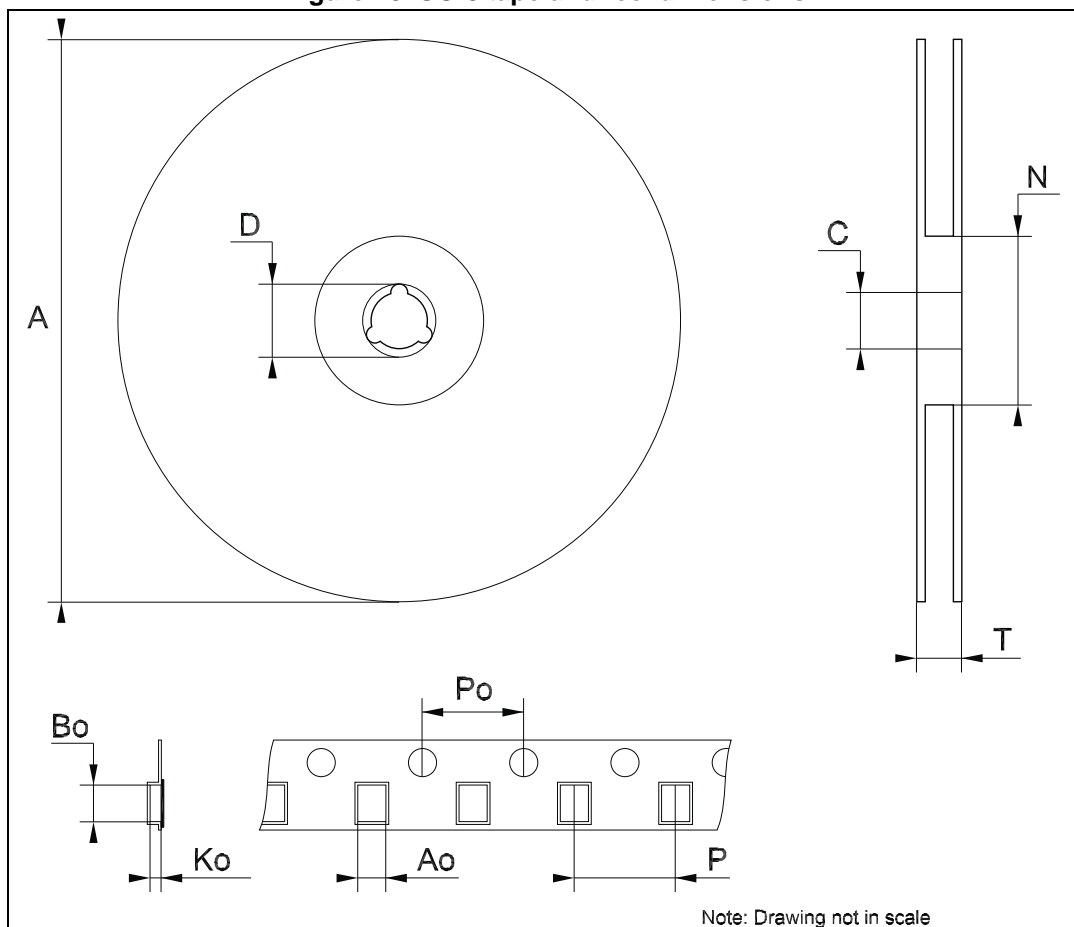

6 Revision history

Table 10. Revision history

Date	Revision	Changes
09-May-2013	1	First revision.
11-Dec-2014	2	Text edits throughout document On cover page: – changed title description – updated <i>Features</i> – updated <i>Description</i> In Table 4 , changed $R_{DS(on)}$ values In Table 5 , changed values and test conditions In Table 6 , changed values and test conditions In Table 7 , changed values and test conditions Added Section 2.1: Electrical characteristics (curves) Updated Section 3: Test circuits Updated Section 4: Package mechanical data

IMPORTANT NOTICE – PLEASE READ CAREFULLY

STMicroelectronics NV and its subsidiaries ("ST") reserve the right to make changes, corrections, enhancements, modifications, and improvements to ST products and/or to this document at any time without notice. Purchasers should obtain the latest relevant information on ST products before placing orders. ST products are sold pursuant to ST's terms and conditions of sale in place at the time of order acknowledgement.

Purchasers are solely responsible for the choice, selection, and use of ST products and ST assumes no liability for application assistance or the design of Purchasers' products.

No license, express or implied, to any intellectual property right is granted by ST herein.

Resale of ST products with provisions different from the information set forth herein shall void any warranty granted by ST for such product.

ST and the ST logo are trademarks of ST. All other product or service names are the property of their respective owners.

Information in this document supersedes and replaces information previously supplied in any prior versions of this document.

© 2014 STMicroelectronics – All rights reserved