

Ultrafast Recovery Rectifier

MUR1650CT

FEATURES

- Ultrafast Recovery Time
- Low Forward Voltage
- Low Leakage Current
- 175°C Operating Junction Temperature
- High Temperature Glass Passivated Junction

MECHANICAL CHARACTERISTICS

- Case: Epoxy, Molded
- Finish: All External Surfaces Corrosion Resistant and Terminal Leads are Readily Solderable
- Lead Temperature for Soldering Purposes: 260°C Max. for 10 Seconds

APPLICATIONS

- Designed for use in switching power supplies, inverters and as free wheeling diodes.

ABSOLUTE MAXIMUM RATINGS(T_a=25°C)

SYMBOL	PARAMETER	VALUE	UNIT
V _{RRM} V _{RWM} V _R	Peak Repetitive Reverse Voltage Working Peak Reverse Voltage DC Blocking Voltage	500	V
I _{F(AV)}	Average Rectified Forward Current Per Leg (Rated V _R) Total Device	8 16	A
I _{FM}	Peak Repetitive Forward Current (Rated V _R , Square Wave,20kHz) Per Diode Leg	16	A
I _{FSM}	Nonrepetitive Peak Surge Current (Surge applied at rated load conditions half-wave, single phase, 60Hz)	100	A
T _J	Junction Temperature	-65~175	°C
T _{stg}	Storage Temperature Range	-65~175	°C

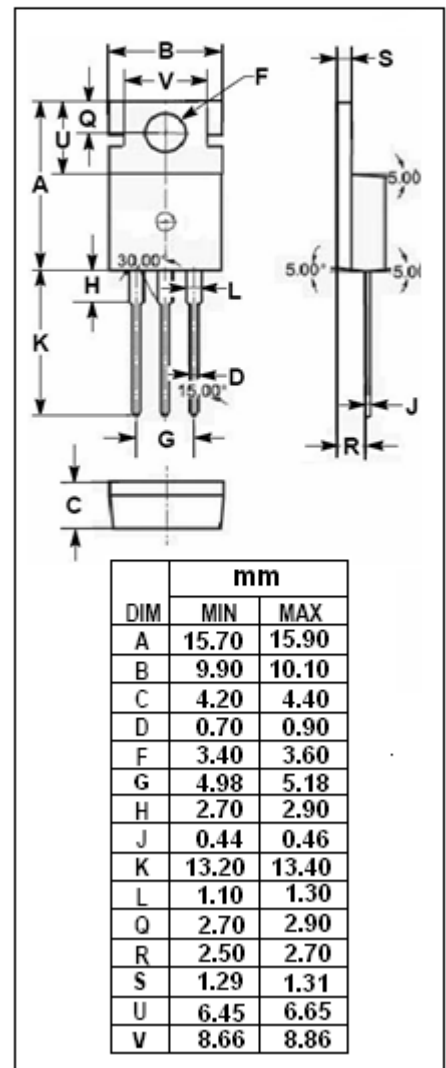
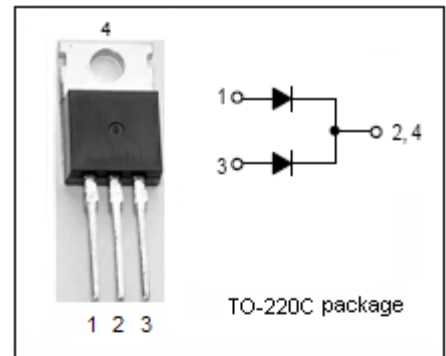

Ultrafast Recovery Rectifier

MUR1650CT

THERMAL CHARACTERISTICS

SYMBOL	PARAMETER	MAX	UNIT
$R_{th\ j-c}$	Thermal Resistance, Junction to Case	2.0	$^{\circ}C/W$

ELECTRICAL CHARACTERISTICS($T_a=25^{\circ}C$) (Pulse Test: Pulse Width=300 μ s, Duty Cycle \leq 2%)

SYMBOL	PARAMETER	CONDITIONS	MAX	UNIT
V_F	Maximum Instantaneous Forward Voltage	$I_F=8A$	1.68	V
I_R	Maximum Instantaneous Reverse Current	$V_{RRM}=500V$	3	μA
t_{rr}	Maximum Reverse Recovery Time	$I_F=0.5A, I_R=1A, I_{rr}=0.25A$	60	ns