

## SPECIFICATION

- Part No.** : **FXP543.A.07.A.001**
- Description** : Venti Circular 2.4/5.8GHz Flexible PCB Antenna  
Internal 3 x MIMO  
100mm 1.37 mini coax cable with IPEX MHFHT
- Features** : Dual Band WiFi MIMO x 3  
Frequency 2.4~2.5GHz, 5.15~5.85GHz  
45% efficiency and 1.5 to 5 dBi peak gain  
Diameter : 37mm, Thickness : 0.15mm  
Port 1, 2, 3 – 100mm Ø1.37 mini coaxial cable with IPEX MHFHT connector (U.FL comp)  
3M adhesive for easy mounting  
RoHS compliant

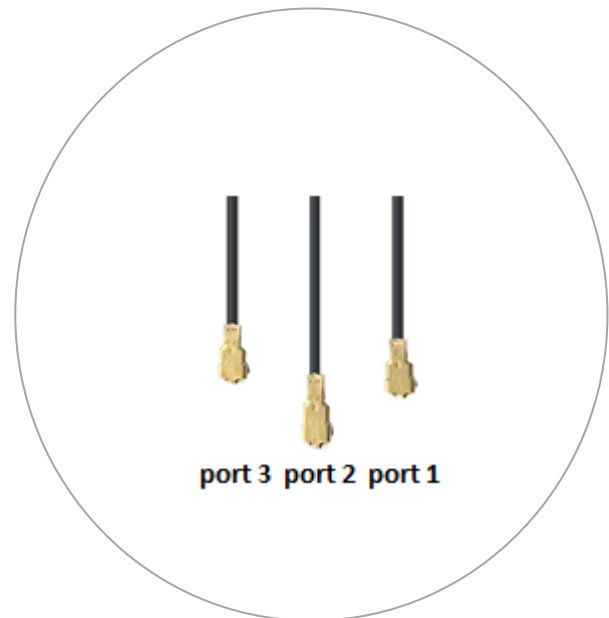

## 1. Introduction

The unique FXP543 Venti Circular antenna is the smallest 3-in-1 MIMO, internal flexible monopole type antenna for WiFi 2.4/5.8GHz in the market. Featuring a thickness of only 0.15mm, the FXP543 is an ideal solution for gateways, routers, smart city applications such as WiFi hot spots, smart lighting control, video surveillance and traffic monitoring.

The FXP543 has over 45% efficiency in both the 2.4GHz and 5GHz bands. It has been designed on a flexible material with a circular form-factor and cable connection for an easy installation. Great care has been taken to have high isolation (at least 10dB) between the three elements to ensure optimal MIMO system throughput.

The antenna comes with double-sided 3M adhesive for easy and robust "peel and stick" mounting. Three cables terminate with IPEX (u.fl) connectors for easy installation.

\*If needed in order to comply with peak gain restrictions with certain wireless modules, the antenna peak gain can be reduced by simply using longer cable, or when tested in the actual device environment.

Many module manufacturers specify peak gain requirements for any antennas that is to be connected to that module. Upon testing of any of our antenna with your device and a selection of appropriate layout, integration technique, or cable, Taoglas can make sure any of our antennas peak gain will be below the peak gain requirements. Taoglas can then issue a specification and/or report for this selected WiFi antennas in your device that will clearly show it complying with the peak gain requirements, so you can be assured you are meeting regulatory requirements for that module.

## 2. Specification

ELECTRICAL *						
	Port 1		Port 2		Port 3	
Frequency(MHz)	2400-2500	5150-5850	2400-2500	5150-5850	2400-2500	5150-5850
Efficiency (%)	47.02	44.25	61.30	47.21	51.13	45.02
Peak Gain (dBi)	2.96	5.16	2.24	3.40	1.80	3.76
Average Gain (dBi)	-3.28	-3.56	-2.13	-3.28	-3.30	-3.38
Return Loss (dB)	< -10	<-9	<-10	<-8	< -8	<-9
Impedance	50 ohms					
Polarization	Linear					
Radiation Property	Omni-Directional					
Max Input Power	5W					
MECHANICAL						
Dimension (mm)	Antenna Diameter=37 Thickness=0.24 with release liner Thickness=0.15 without release liner					
Cable	3 * 1.37 coaxial cable					
Cable Length	100mm					
Connector	IPEX MHFHT					
Weight (g)	2.4					
ENVIRONMENTAL						
Operation Temperature	-40°C to 85°C					
Humidity	Non-condensing 65°C 95% RH					

\* Electrical characteristics are measured on 2mm thick ABS board.

### 3. Antenna Characteristics

#### 3.1. Return Loss

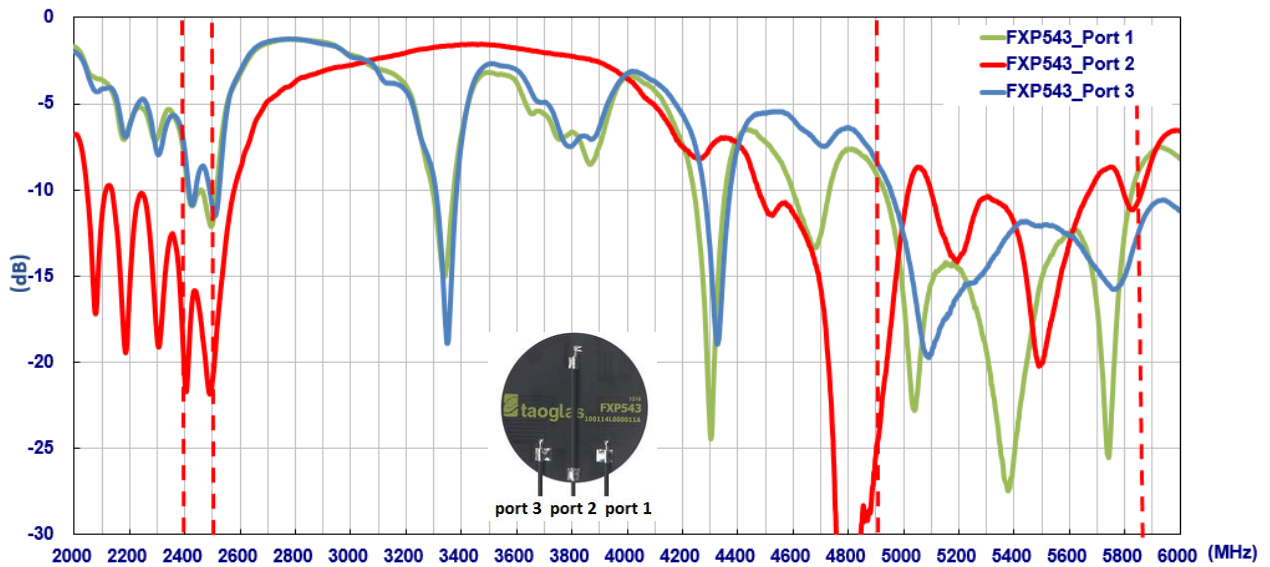

#### 3.2. Isolation

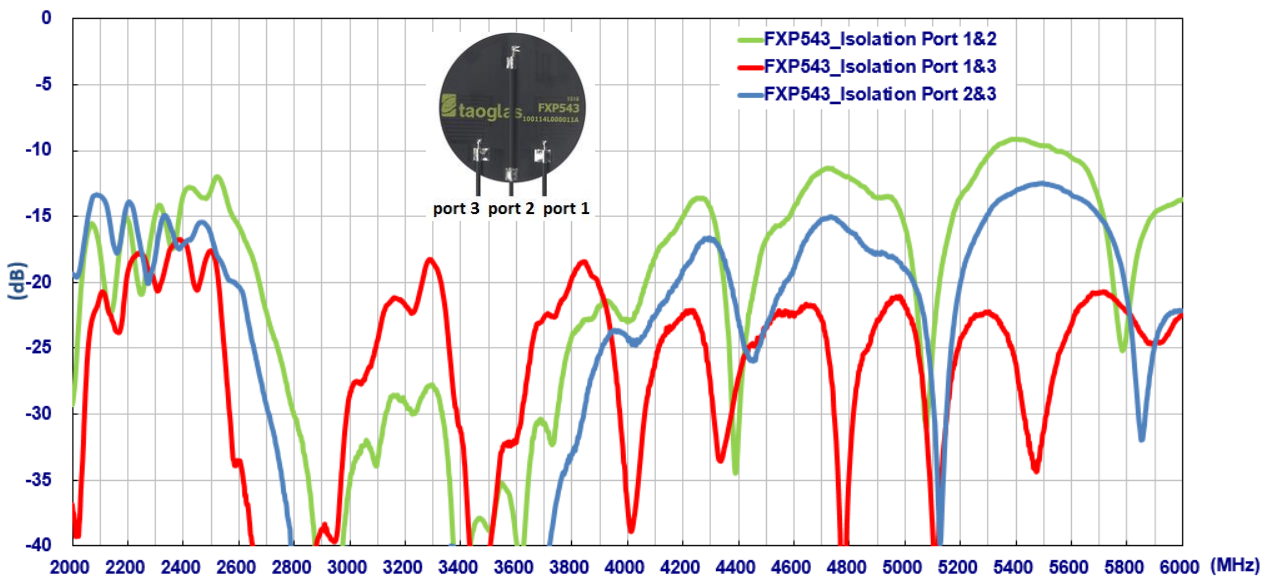

### 3.3. Efficiency

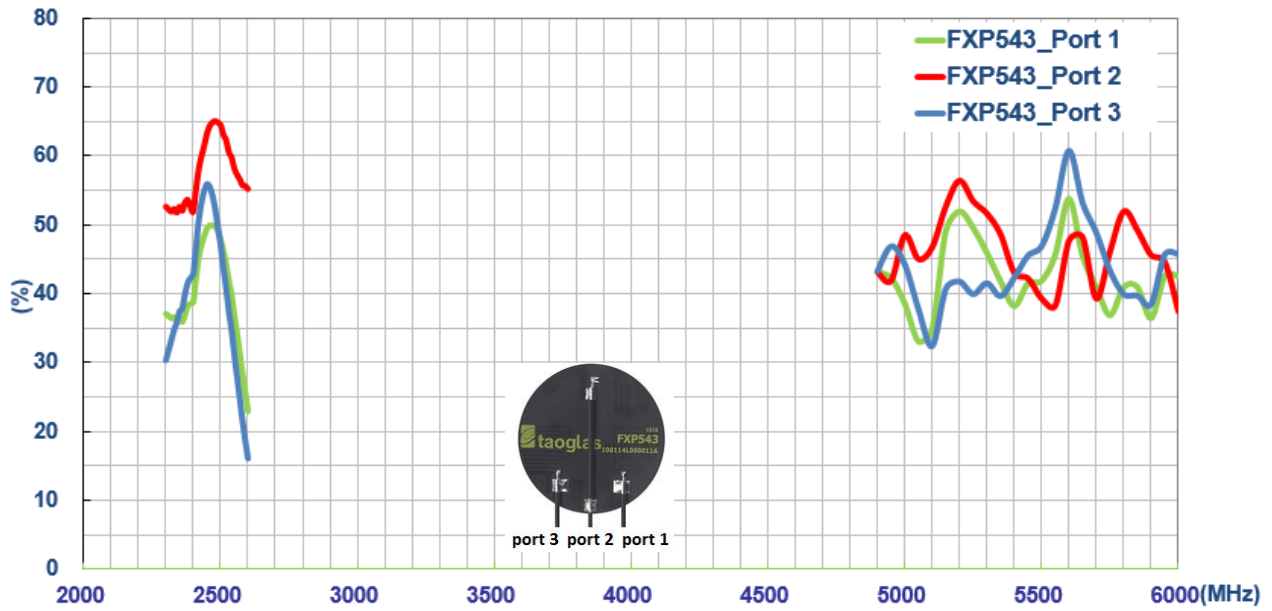

### 3.4. Average Gain

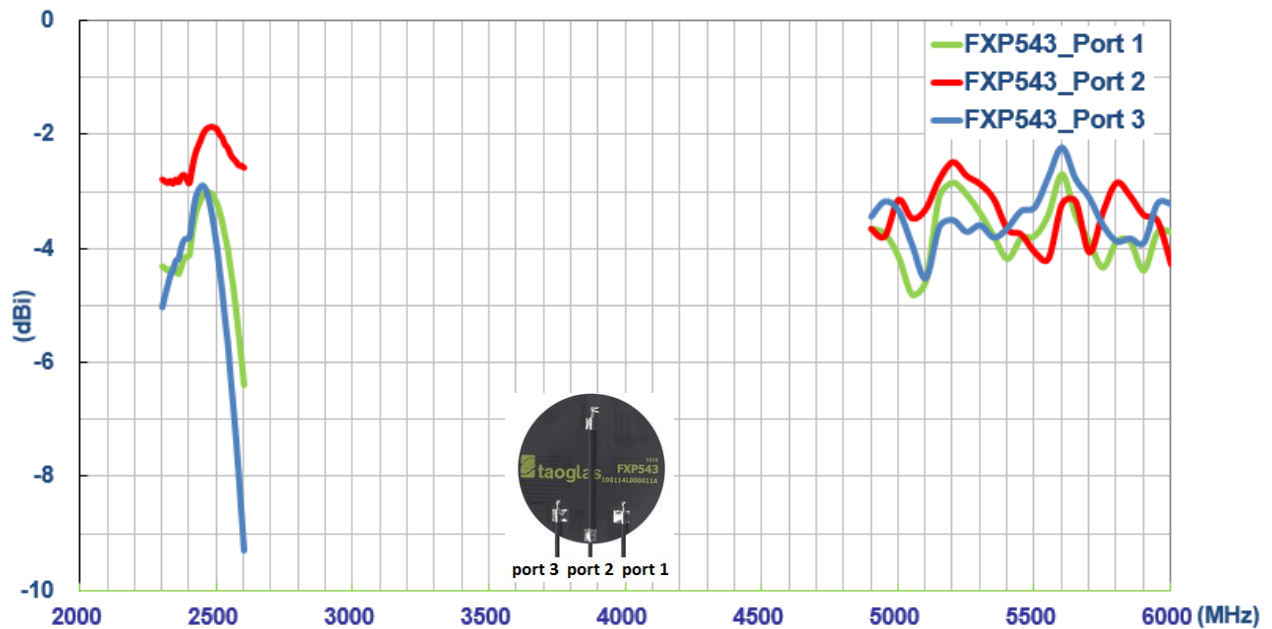

### 3.5. Peak Gain

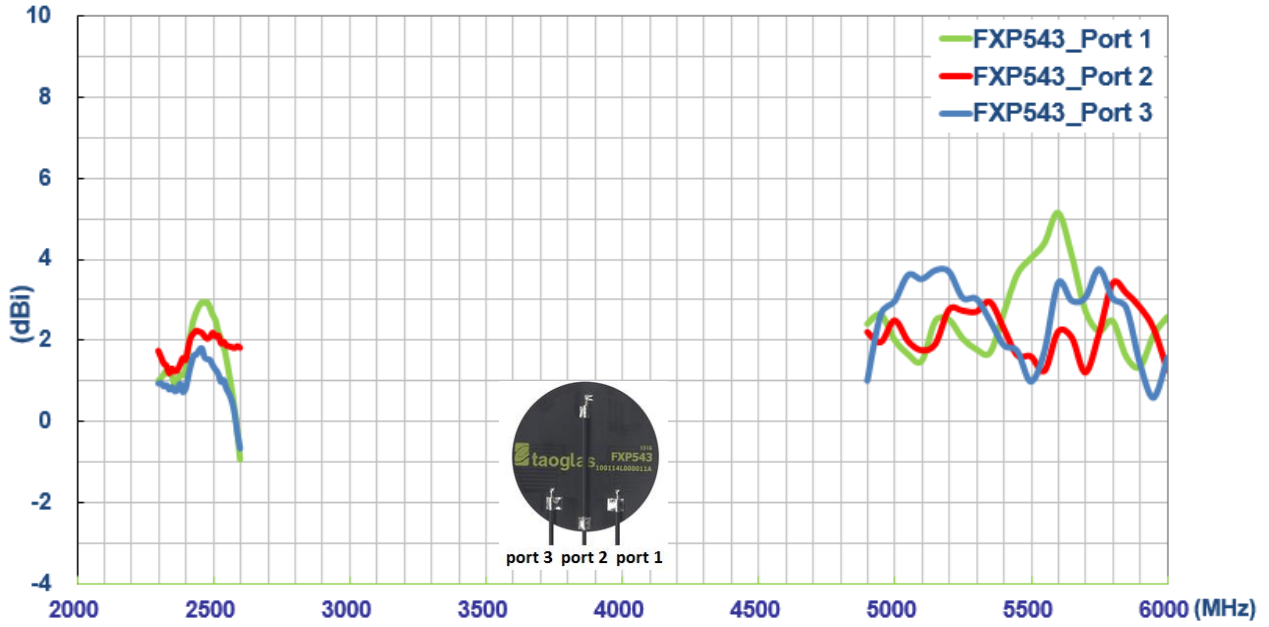

## 4. Antenna Radiation Pattern

### 4.1. Measurement Setup

The FXP543 antenna is tested in a CTIA certified ETS-Lindgren Anechoic Chamber. The test setup is shown below.

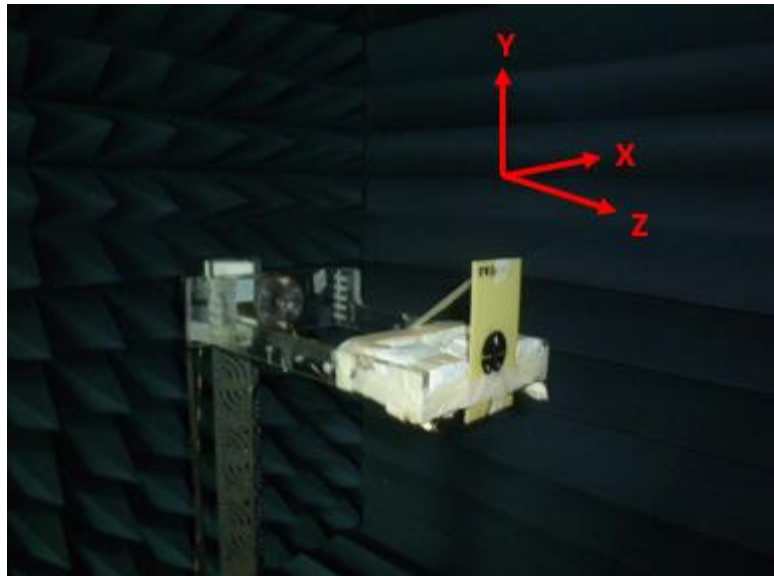

## 4.2. 2D Radiation Pattern

- 2400MHz

XY Plane

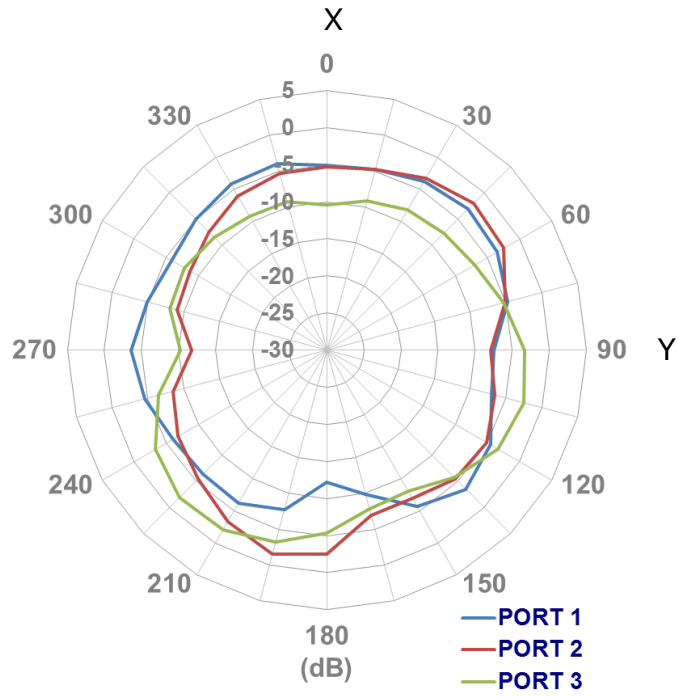

XZ Plane

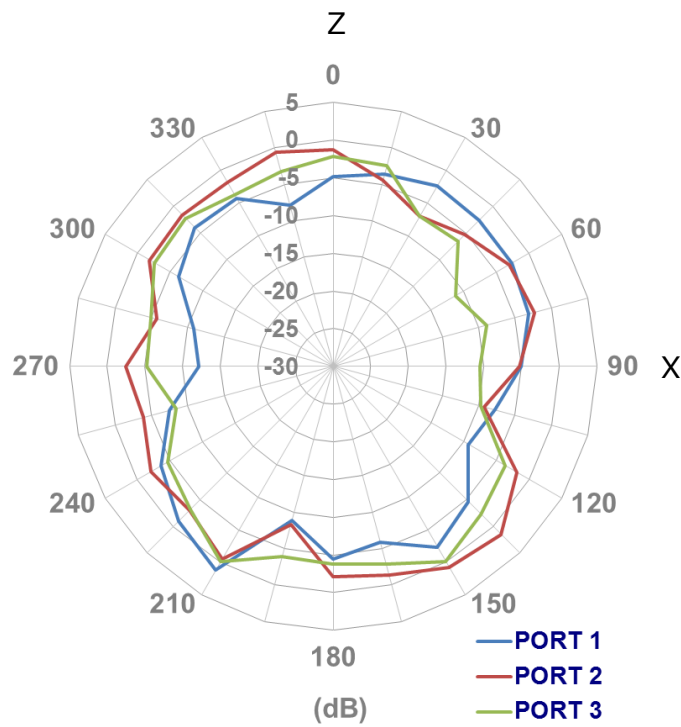



YZ Plane

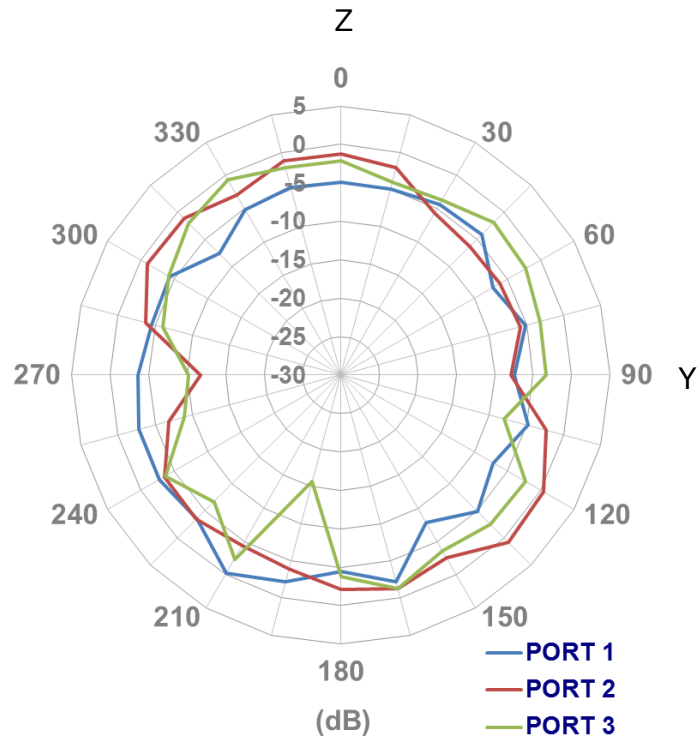

- 2450MHz

XY Plane

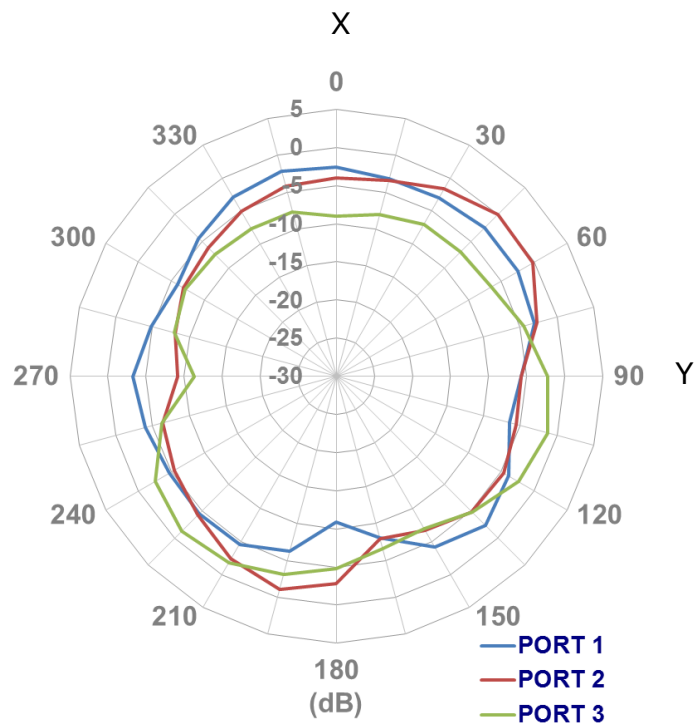

XZ Plane

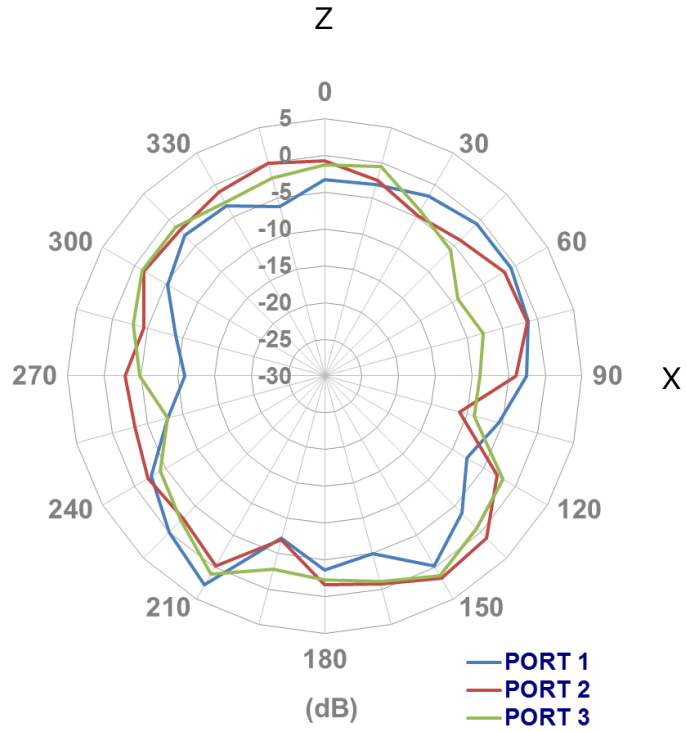

YZ Plane

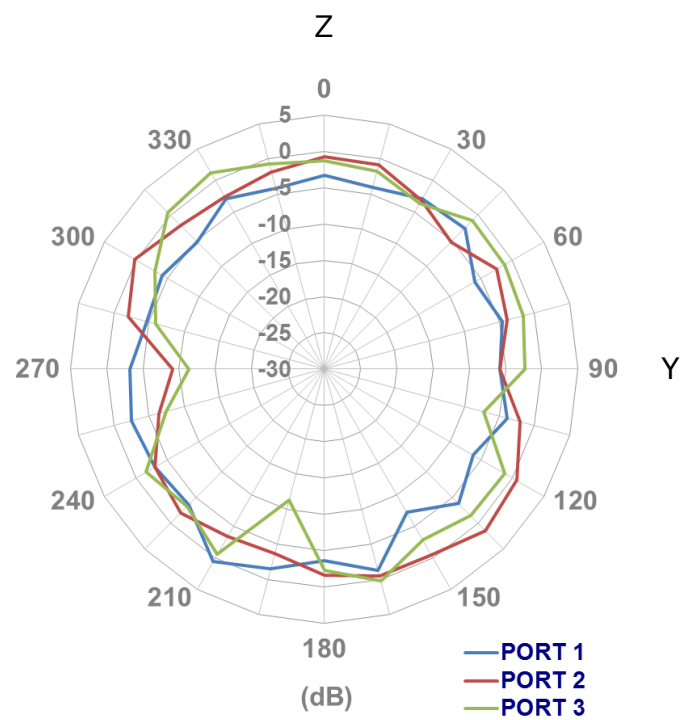

- **2500MHz**

XY Plane

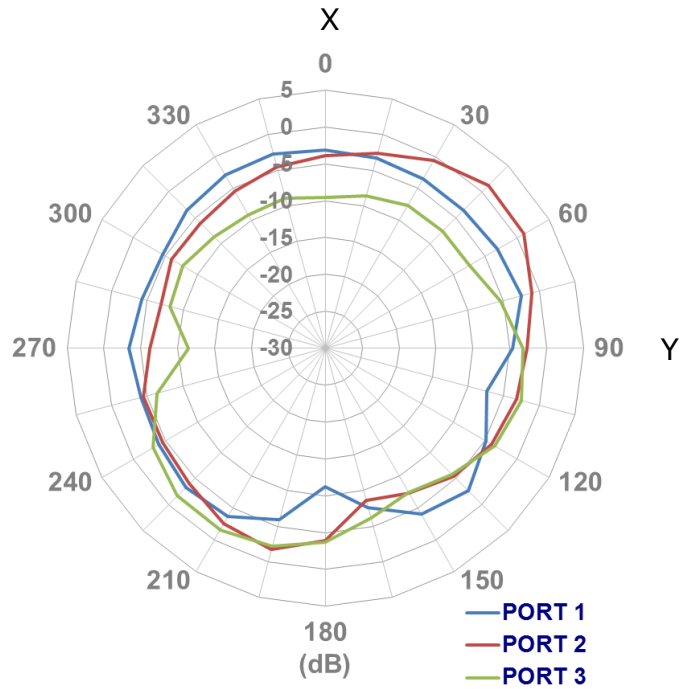

XZ Plane

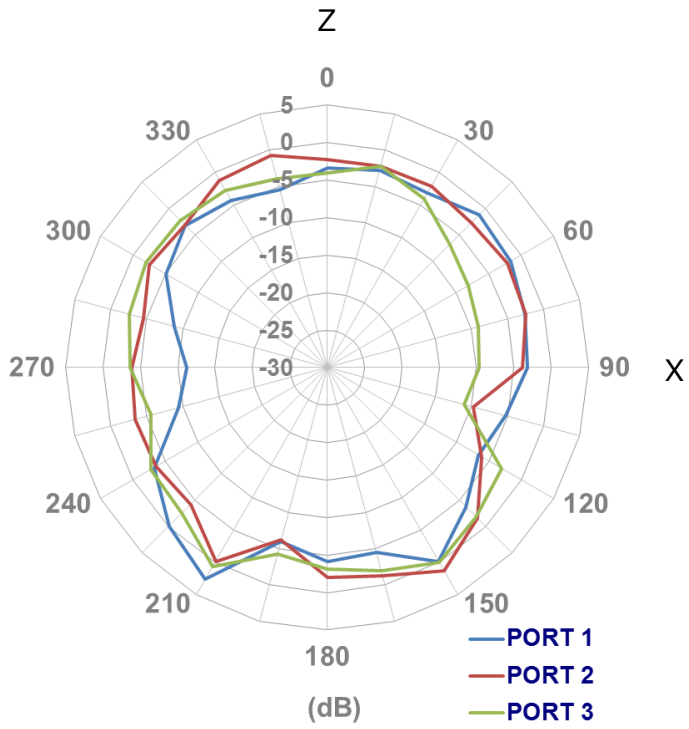

YZ Plane

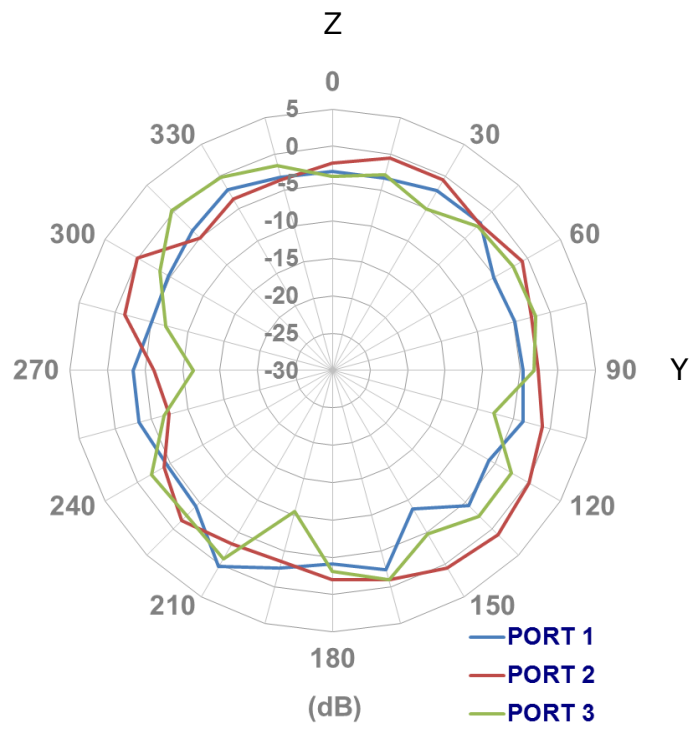

- 5150MHz

XY Plane

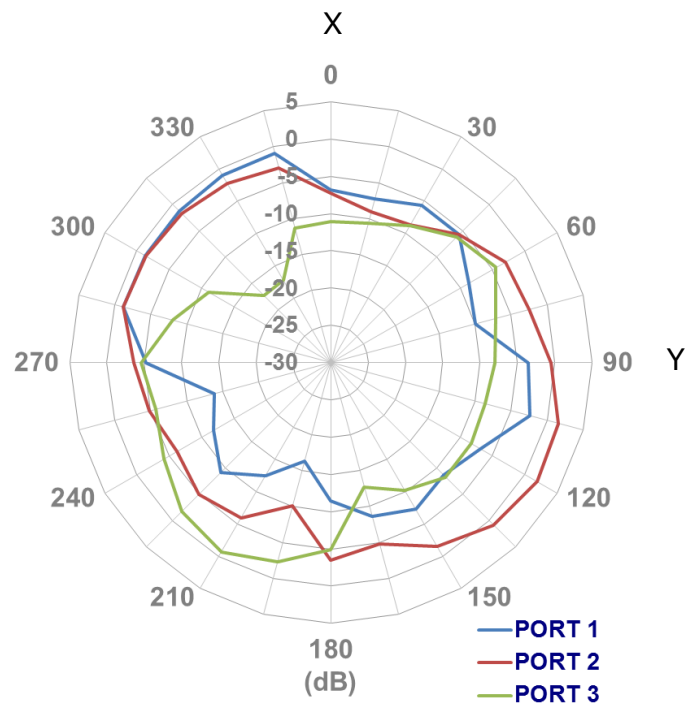

XZ Plane

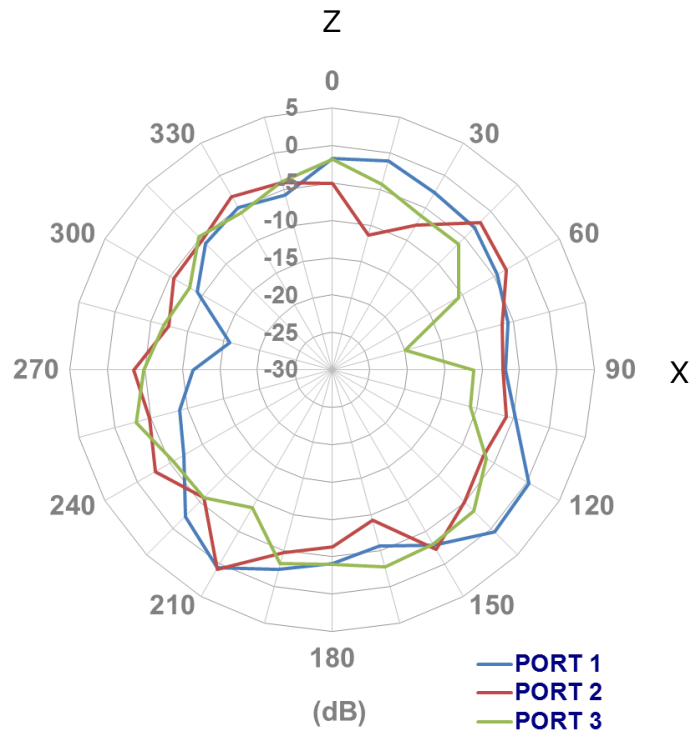

YZ Plane

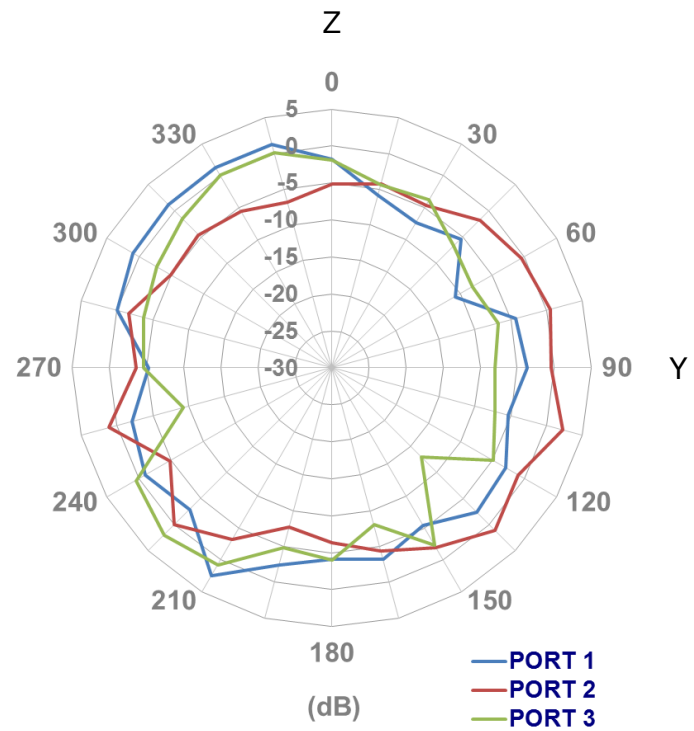

- **5500MHz**  
XY Plane

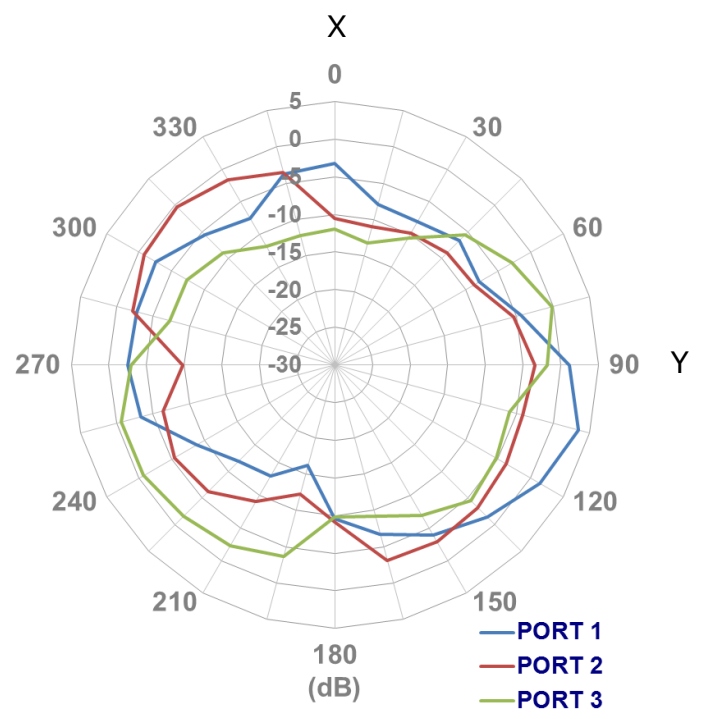

XZ Plane

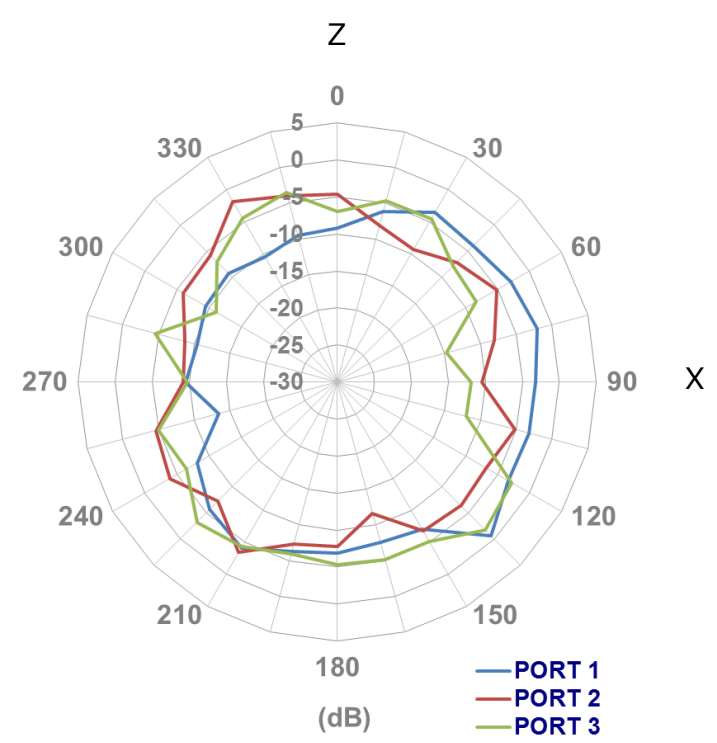

YZ Plane

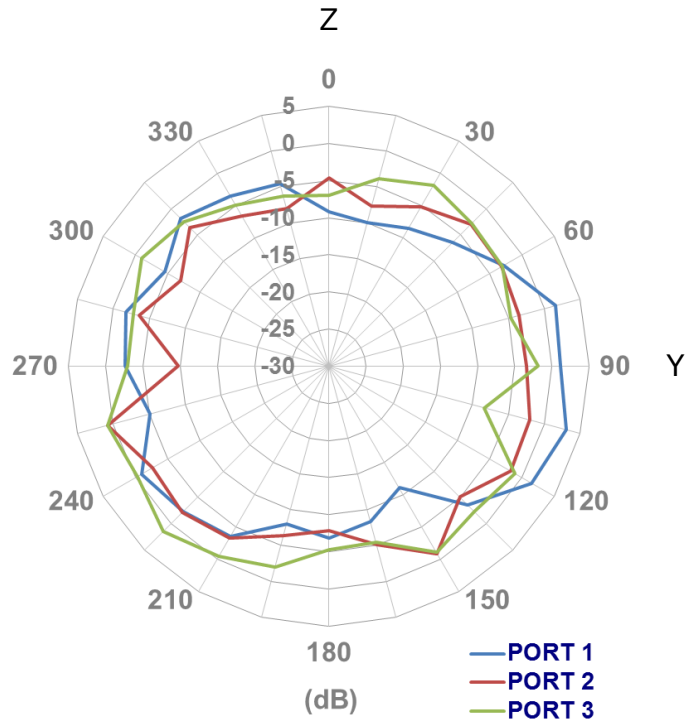

- 5850MHz  
XY Plane

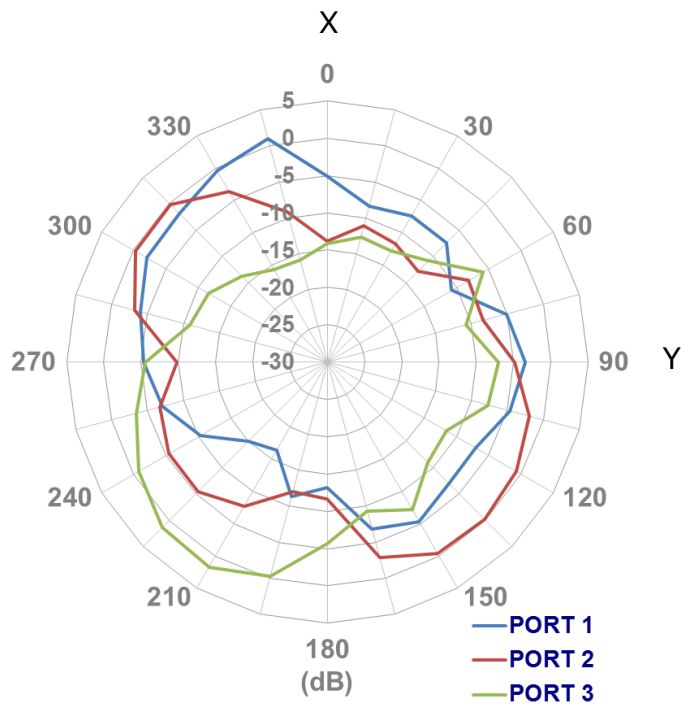

XZ Plane

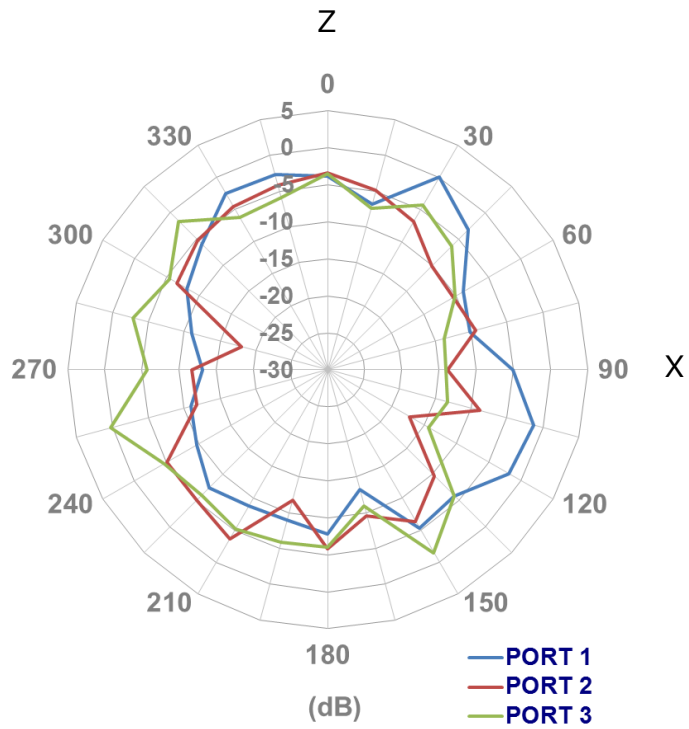

YZ Plane

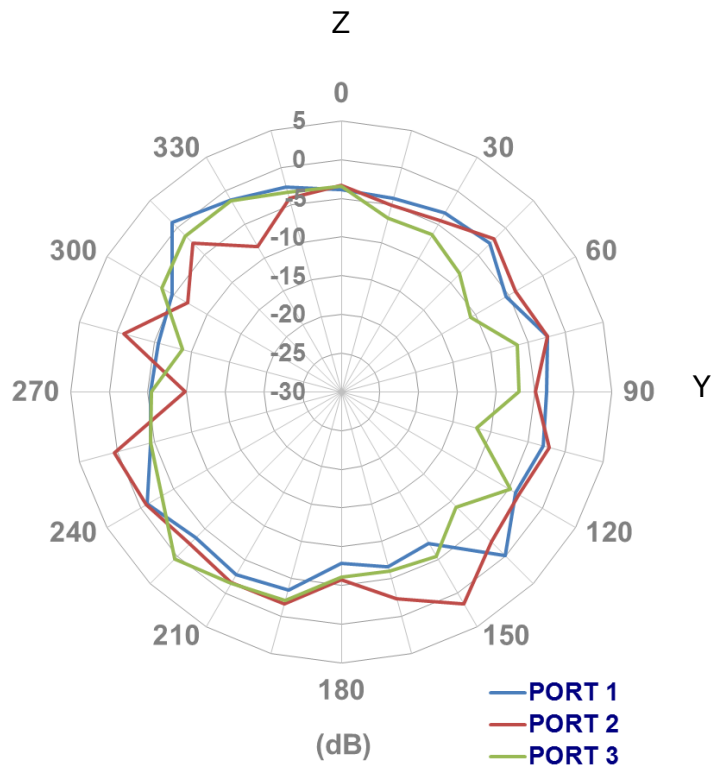



### 4.3. 3D Radiation Pattern

Port 1 @2450MHz

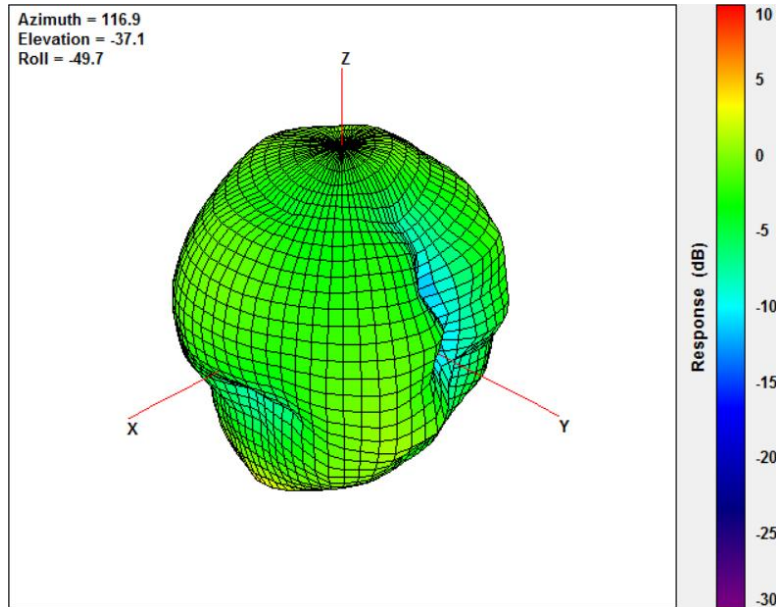

Port 1 @5550MHz

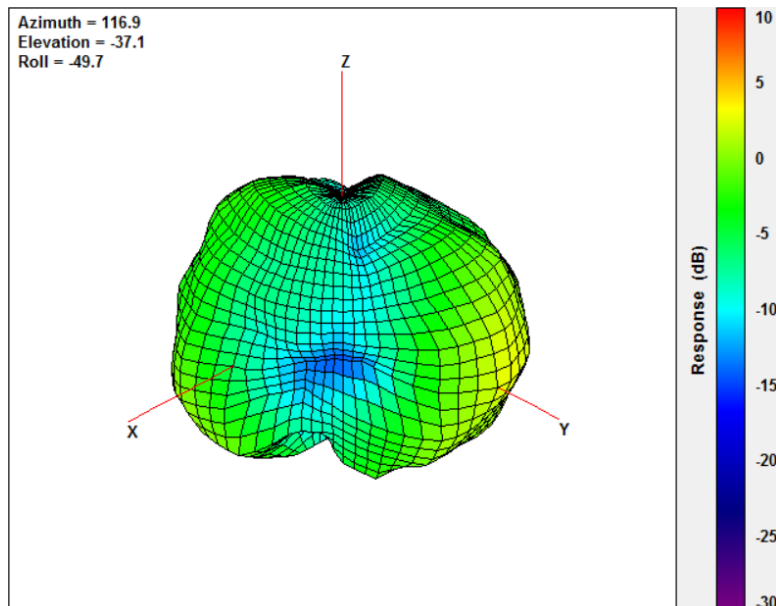

Port 2 @2450MHz

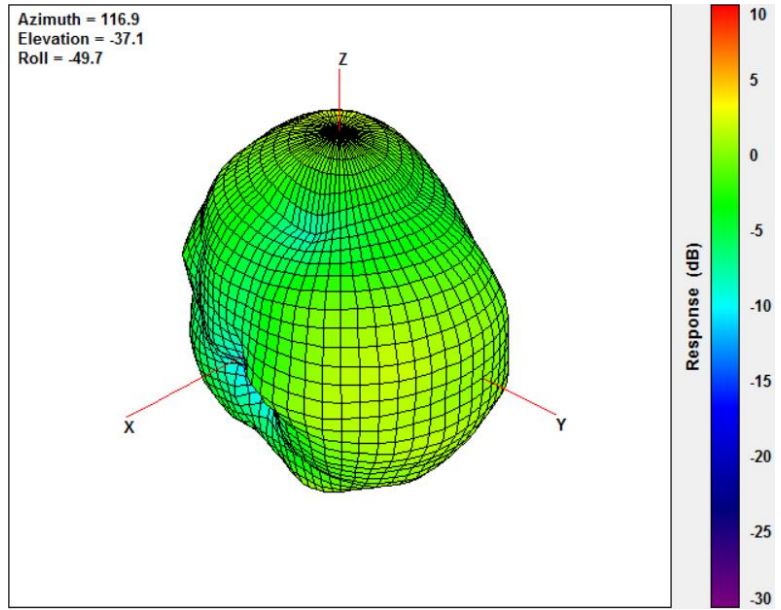

Port 2 @5550MHz

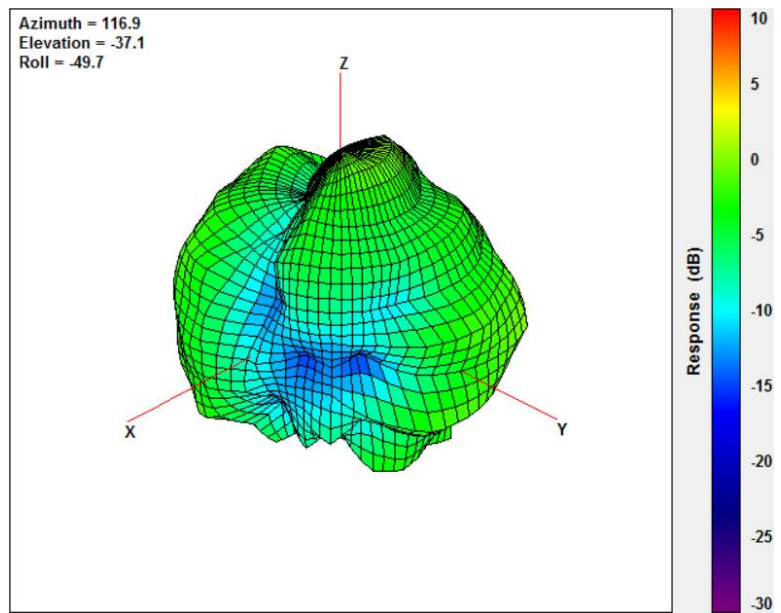

Port 3 @2450MHz

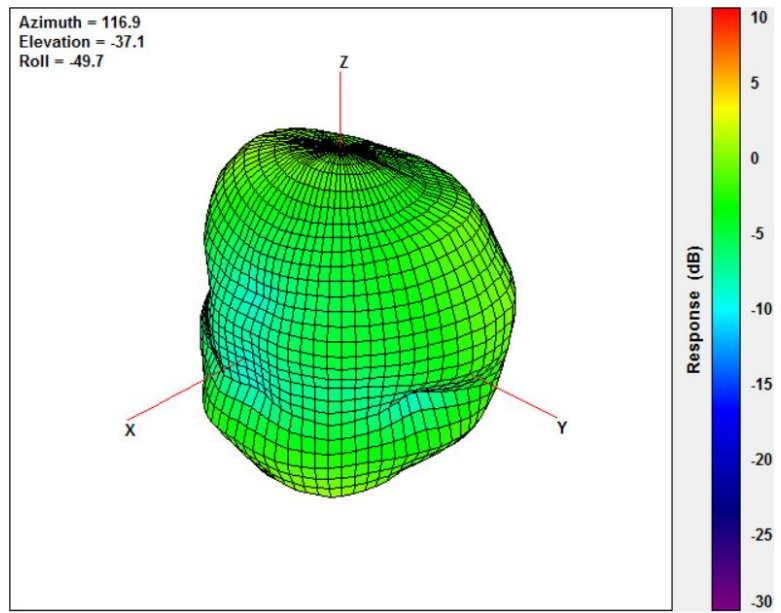

Port 3 @5550MHz

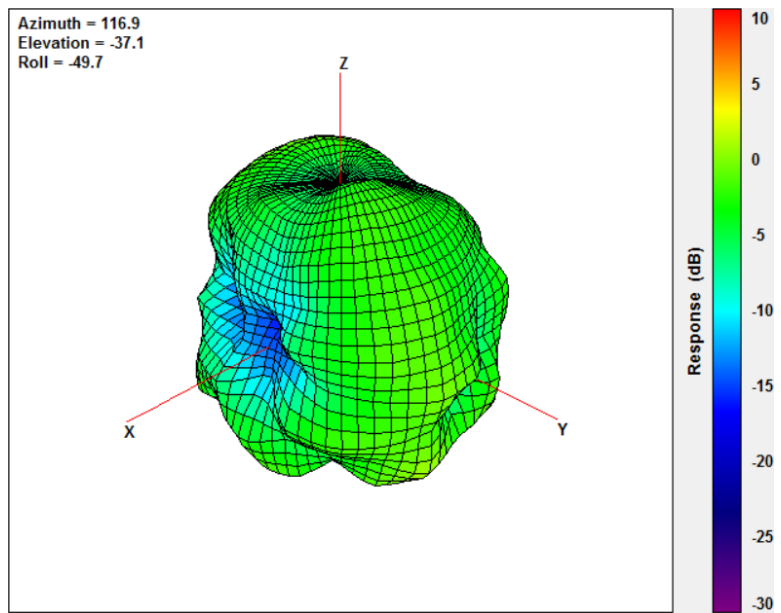



# 5. Mechanical Drawing

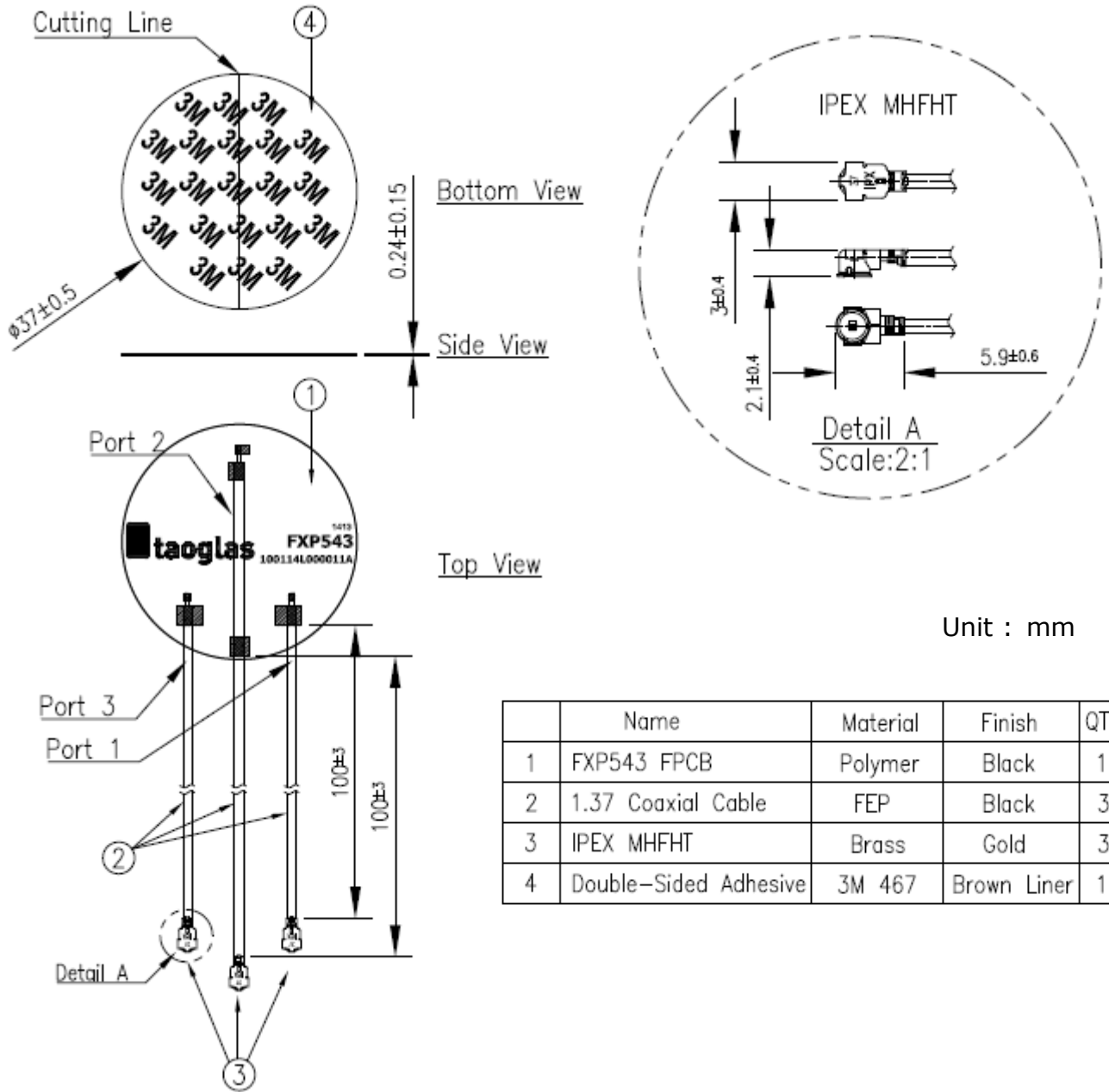

## 6. Packaging

### FXP543.A.07.A.001

#### Packaging Specifications

50 pcs FXP543.A.07.A.001 per PE bag  
 PE Bag Dimensions - 275 x 160mm  
 Weight - 130g

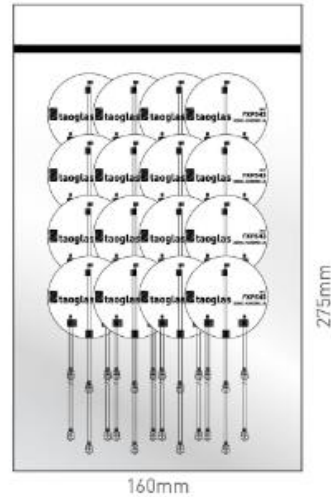

100 PE bags per carton  
 5000 pcs FXP543.A.07.A.001 per carton  
 Carton Dimensions - 320\*250\*230 mm  
 Weight - 13Kg

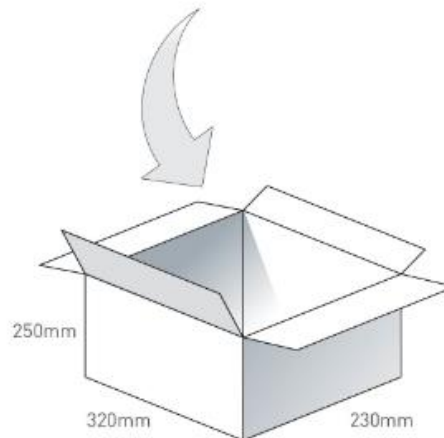

Pallet Dimensions 1100\*1100\*1070mm  
 48 Cartons per Pallet  
 12 Cartons per layer  
 4 Layers

