

## DETAILS

<b>Product Number</b>	F14304_FLORENCE-1R-Z90
<b>Family</b>	Florence
<b>Type</b>	Lens
<b>Color</b>	clear
<b>Diameter</b>	19,5 x 286 mm
<b>Height</b>	7 mm
<b>Style</b>	rectang
<b>Optic Material</b>	PMMA
<b>Holder Material</b>	
<b>Fastening</b>	clips
<b>Status</b>	production ready
<b>ROHS Compliant</b>	Yes
<b>Date Updated</b>	26/01/2017



## OPTICAL PROPERTIES

LED	Viewing Angle	Light Beam	Efficiency	cd/lm	Connector
L0-280024-xxx-C0800-L267	88+106 deg	WWW-class	92 %	0.400	-
XH-B/G	97+117 deg	WWW-class	90 %	0.350	-
LUXEON 3535 2D	92+110 deg	WWW-class	93 %	0.390	-
LUXEON 3030 2D	88+108 deg	WWW-class	92 %	0.420	-
LUXEON 3014	91+109 deg	WWW-class	94 %	0.420	-
LUXEON 3535L	92+109 deg	WWW-class	94 %	0.410	-
LUXEON 3020	89+108 deg	WWW-class	94 %	0.430	-
MP-2016	89+108 deg	WWW-class	93 %	0.420	-
NF2x757D	90+110 deg	WWW-class	93 %	0.400	-
NF2x757G	90+108 deg	WWW-class	92 %	0.400	-
Duris S5 (2 chip)	90+113 deg	WWW-class	94 %	0.400	-
Duris E 2835	sim: 94+106	WWW-class	sim: 93 %	sim: 0.390	-
Fortimo LED Line 1ft 1100lm xx0 1R xV2	90+110 deg	WWW-class	94 %	0.410	-
Fortimo LED Line 1ft 1100lm xx0 1R xV2	MUL deg	WWW-class	-	-	-
Fortimo LED Line 1ft 1100lm xx0 1R xV2	MUL deg	WWW-class	-	-	-
LM302A	90+108 deg	WWW-class	93 %	0.410	-
LM561B	91+109 deg	WWW-class	93 %	0.390	-
LM301A	89+109 deg	WWW-class	94 %	0.430	-
LT-S282N	91+109 deg	WWW-class	94 %	0.420	-
LM561C	90+110 deg	WWW-class	94 %	0.420	-
LM28xB Series	91+111 deg	WWW-class	94 %	0.420	-
SEOUL 3030	90+109 deg	WWW-class	92 %	0.410	-
SunLike 3030	103+86 deg	WWW-class	94 %	0.430	-
CALGD0414-M8W1	89+115 deg	WWW-class	93 %	0.380	-
CALGD0814-M17W1	90+114 deg	WWW-class	93 %	0.380	-



**PRODUCT DATASHEET**  
**Florence series**  
last update 26/1/2017

**OPTICAL PROPERTIES**

LED	Viewing Angle	Light Beam	Effi- ciency	cd/lm	Connector
-----	------------------	---------------	-----------------	-------	-----------

H G F E D C B A

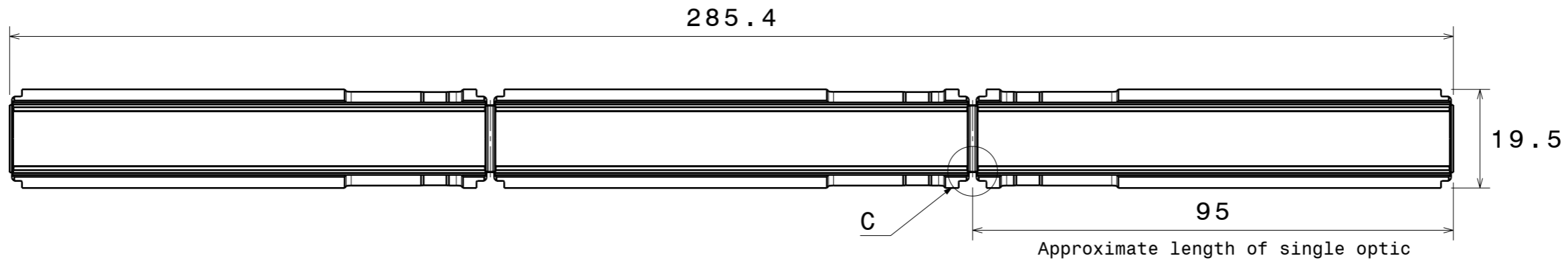

Bottom view

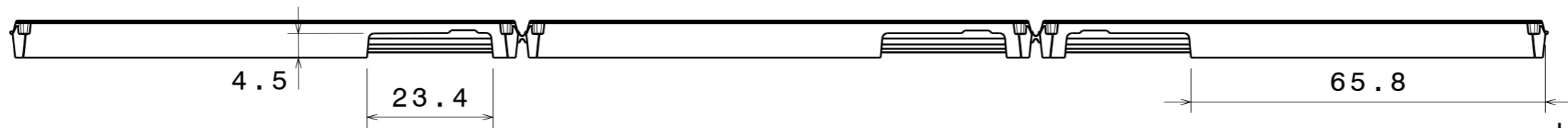

Left view

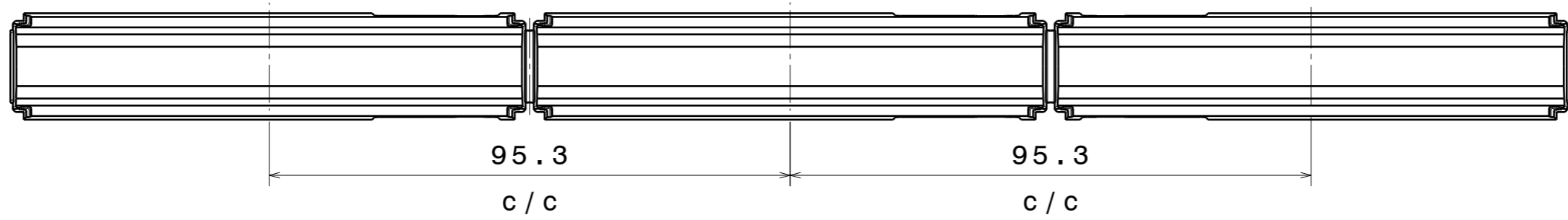

Top view

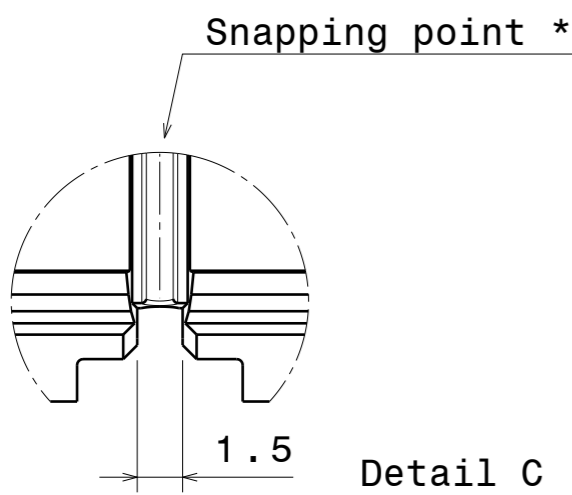

Detail C  
Scale 4:1

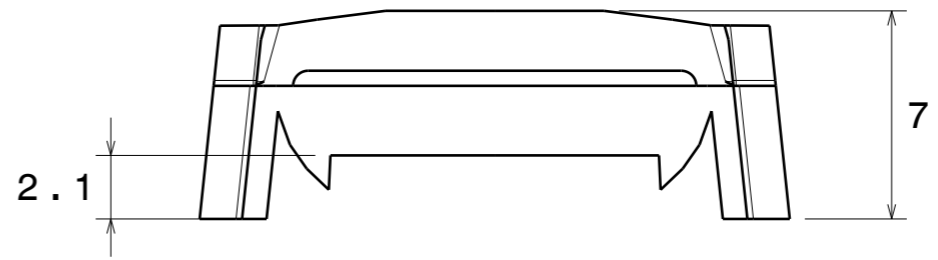

Front view  
Scale 4:1

\* Optics can be snapped along this line and used also as single parts.

Tolerances if not otherwise shown  
According to DIN ISO 2768-1  
Linear measures:  
Up to 30mm class M, otherwise class C.  
According to DIN ISO 2768-2  
Form and position: class L

**LEDiL** LediL Oy  
Salorankatu 10  
FIN 24240 SALO  
Finland

THIRD ANGLE PROJECTION:

DRAWING TITLE  
**Datasheet FLORENCE-1R**

This drawing is the property of LEDiL Oy. It may not be reproduced, copied or communicated without a written agreement with LEDiL Oy.

SIZE	PART NUMBER		
A3	-		

SCALE	1:1	WEIGHT	-	SHEET	1/1
-------	-----	--------	---	-------	-----

H G B A

Luminaire: Ledil F14304\_FLORENCE-1R-Z90\_(CeZos)

Lamps: 1 x CeZos\_(L0-280024-xxx-C0800-L267)\_1346.29lm@250mA\_CCT=3000K\_P=8.5017W\_I=0.25A

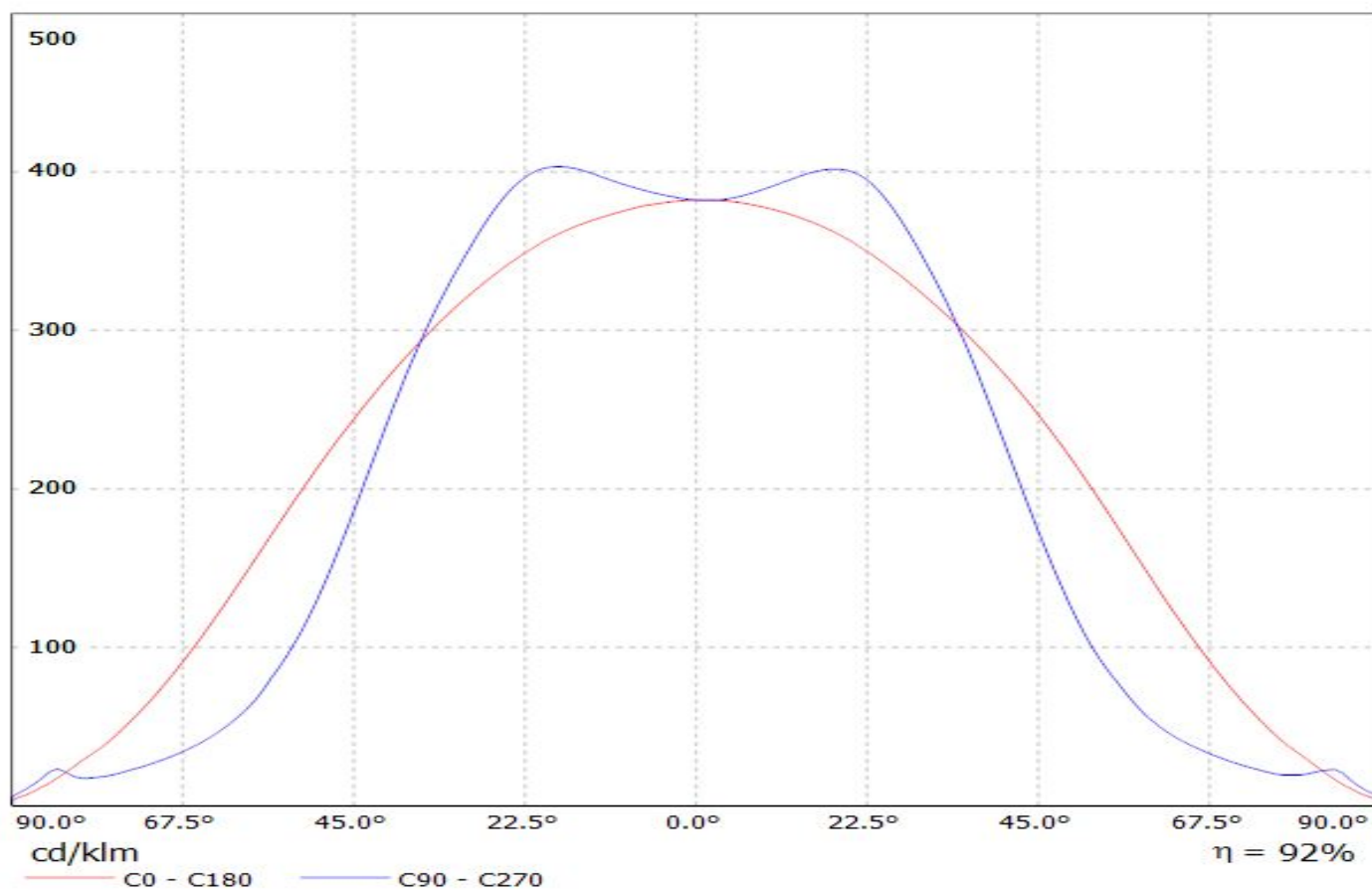

# Ledil F14304\_FLORENCE-1R-Z90\_(XH-B) / LDC (Linear)

Luminaire: Ledil F14304\_FLORENCE-1R-Z90\_(XH-B)

Lamps: 1 x Cree\_XH-B\_x22\_(XHBAAWT-0-7B4-J20-0H-0001)\_315.848lm@65mA\_P=2.11W\_I=65mA

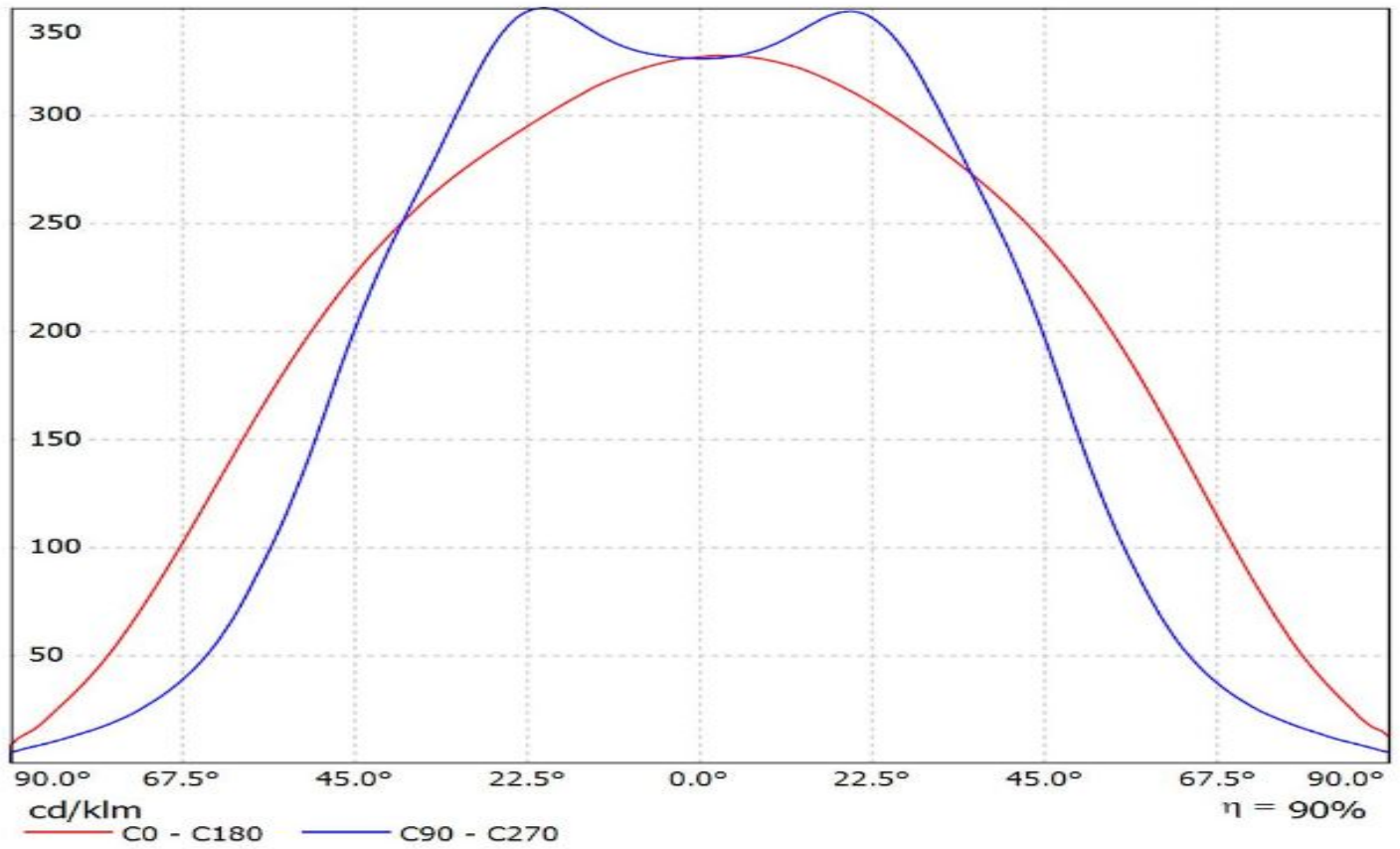

# Ledil F14304\_FLORENCE-1R-Z90\_(Luxeon\_3535\_2D) / LDC (Linear)

Luminaire: Ledil F14304\_FLORENCE-1R-Z90\_(Luxeon\_3535\_2D)

Lamps: 1 x Luxeon\_3535\_2D\_x22\_(MXC8\_4000K)\_910.245lm@100mA\_CCT=4000K\_P=6.32W\_I=0.1A

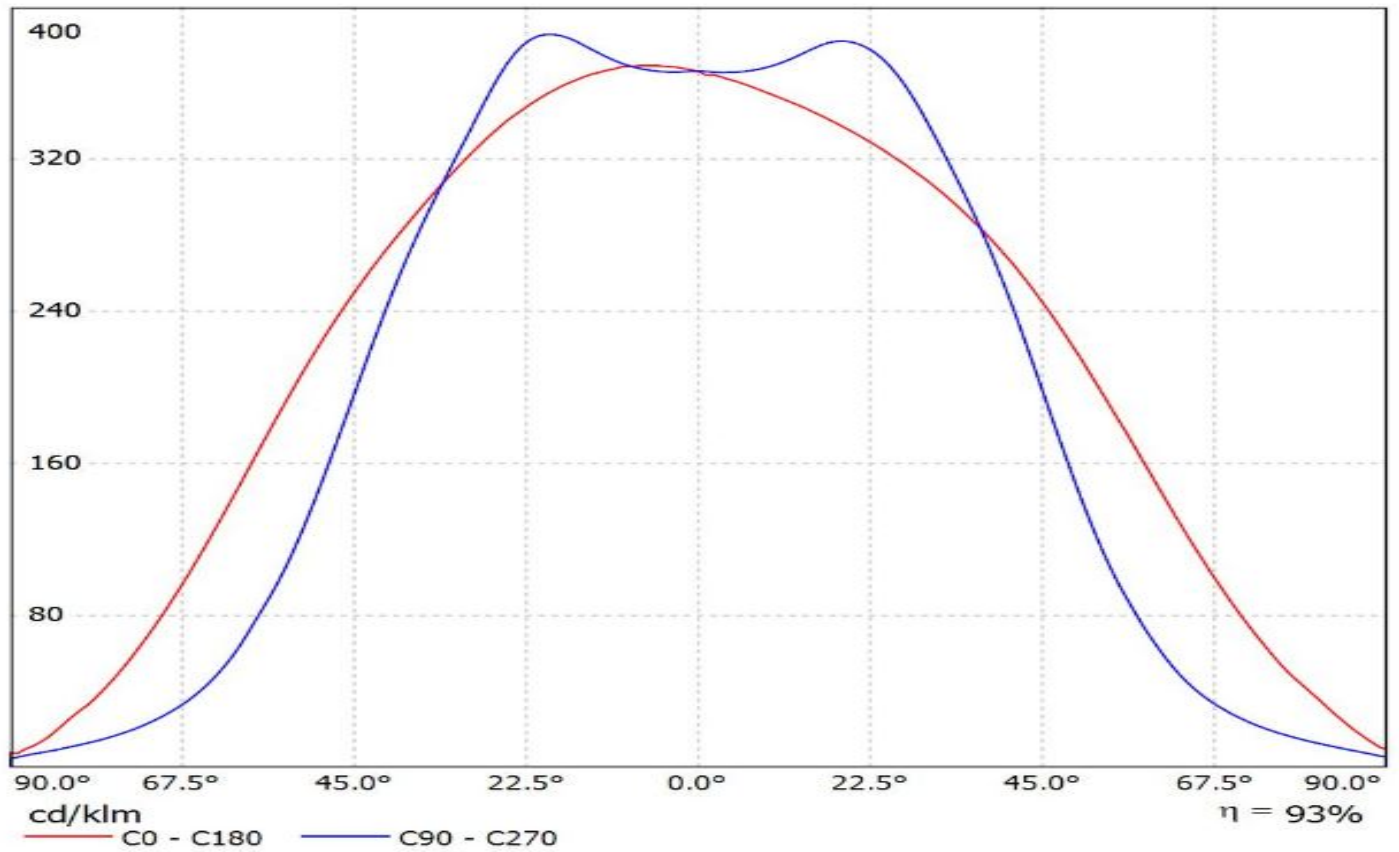

# Ledil F14304\_FLORENCE-1R-Z90\_(Luxeon\_3030\_2D) / LDC (Linear)

Luminaire: Ledil F14304\_FLORENCE-1R-Z90\_(Luxeon\_3030\_2D)  
Lamps: 1 x Luxeon\_3030\_2D\_x22\_(L130-4080003000W21)  
\_1601.44lm@200mA\_CCT=4000K\_P=12.8W\_I=0.2A

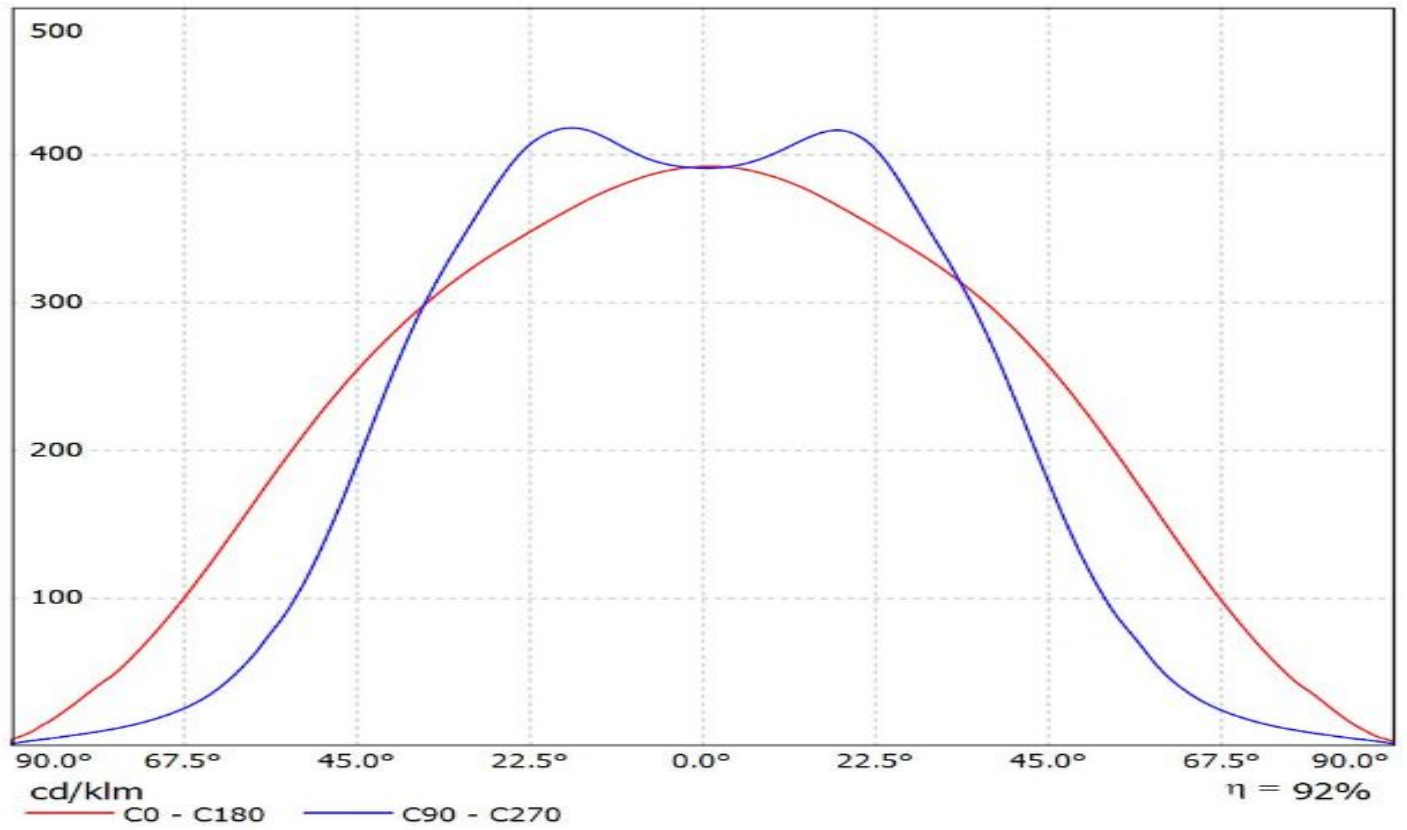

Luminaire: Ledil F14304\_FLORENCE-1R-Z90\_(3014\_x22)

Lamps: 1 x Luxeon\_3014\_x22\_(L130-5080)\_282.652lm@60mA\_P=1.9076W\_I=0.060mA

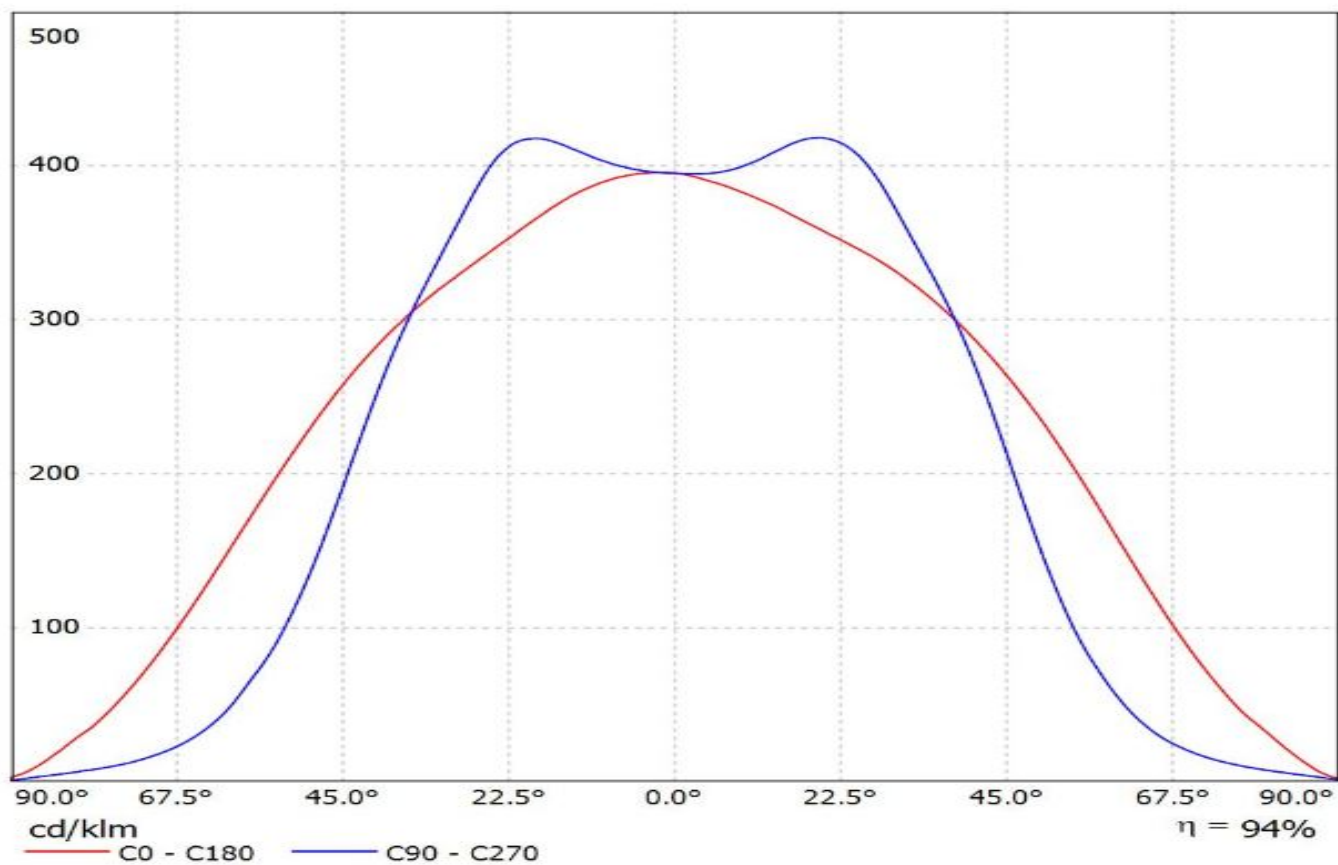



Luminaire: Ledil F14304\_FLORENCE-1R-Z90\_(3535L\_x22)

Lamps: 1 x Luxeon\_3535L\_x22\_(MXA8-PW50)\_507.681lm@100mA\_P=2.9953W\_I=0.100mA

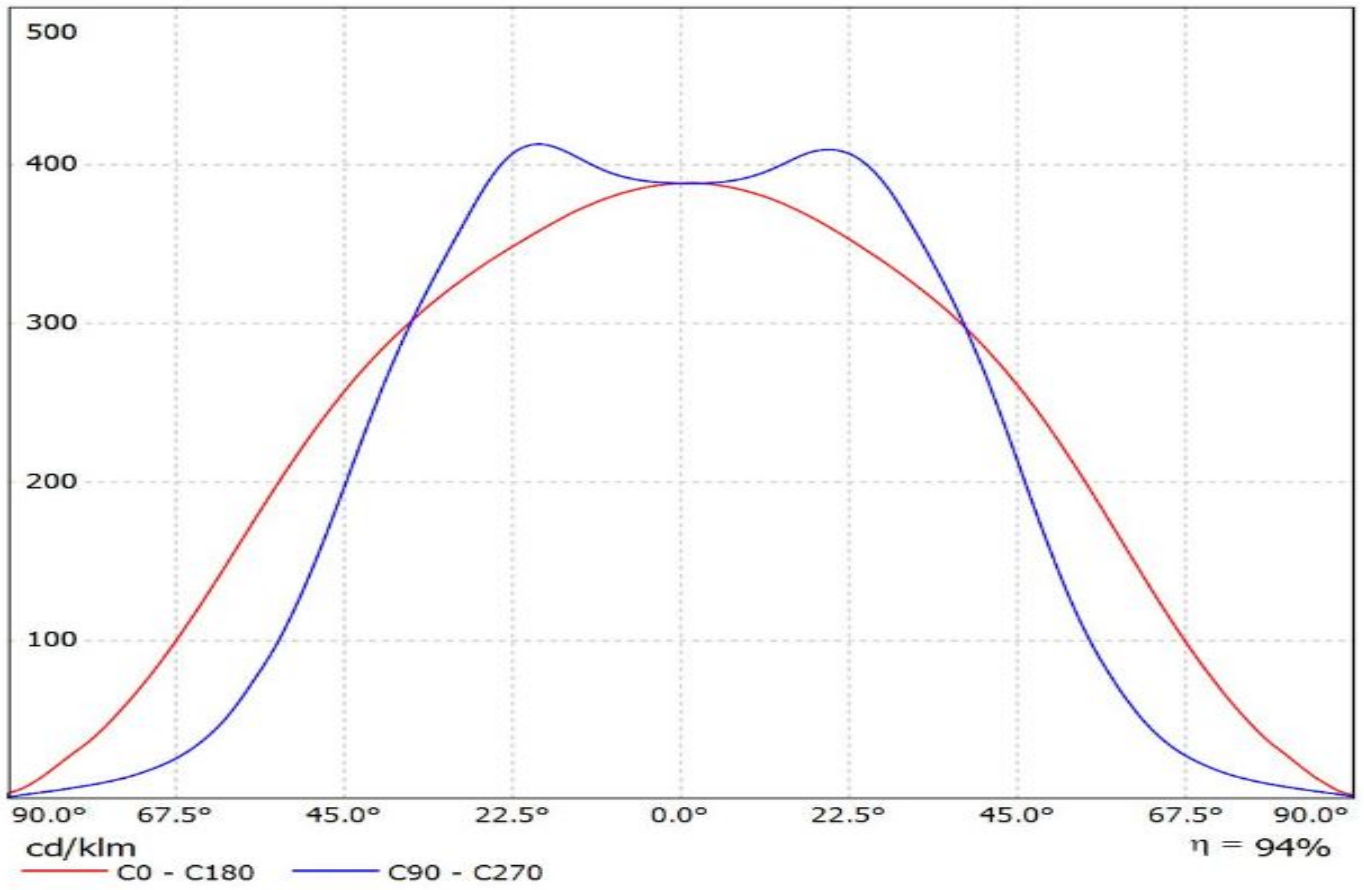

Luminaire: Ledil F14304\_FLORENCE-1R-Z90\_(3020)

Lamps: 1 x Luxeon\_3020\_x22\_(L130-2780)\_488.066lm@120mA\_P=3.7731W\_I=0.120mA

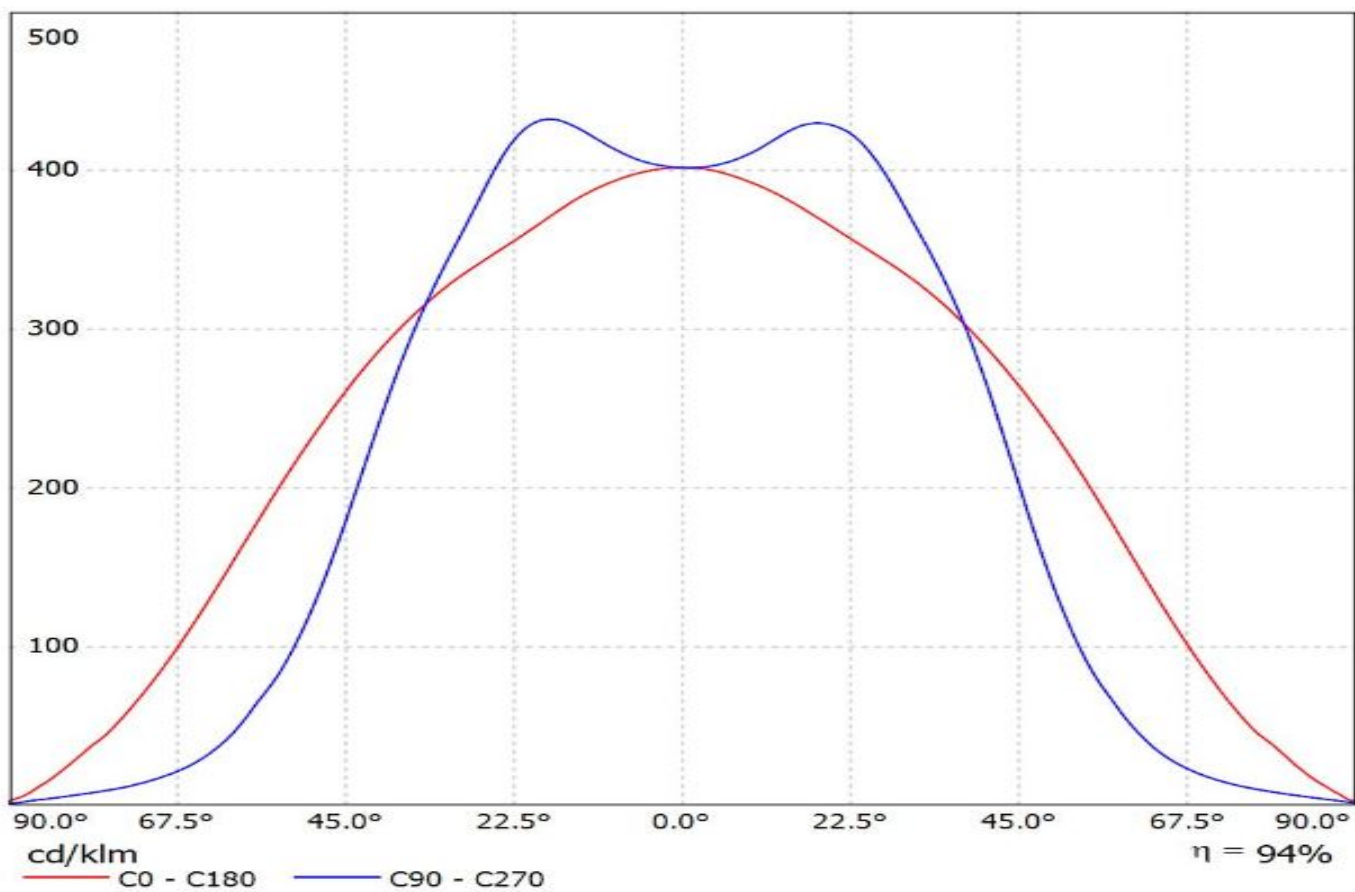

# Ledil F14304\_FLORENCE-1R-Z90\_(Luminus\_MP-2016) / LDC (Linear)

Luminaire: Ledil F14304\_FLORENCE-1R-Z90\_(Luminus\_MP-2016)

Lamps: 1 x Luminus\_MP-2016\_1x22\_(LUMMP-1100-30-80)\_471.904lm@120mA\_P=4W\_I=0.12A

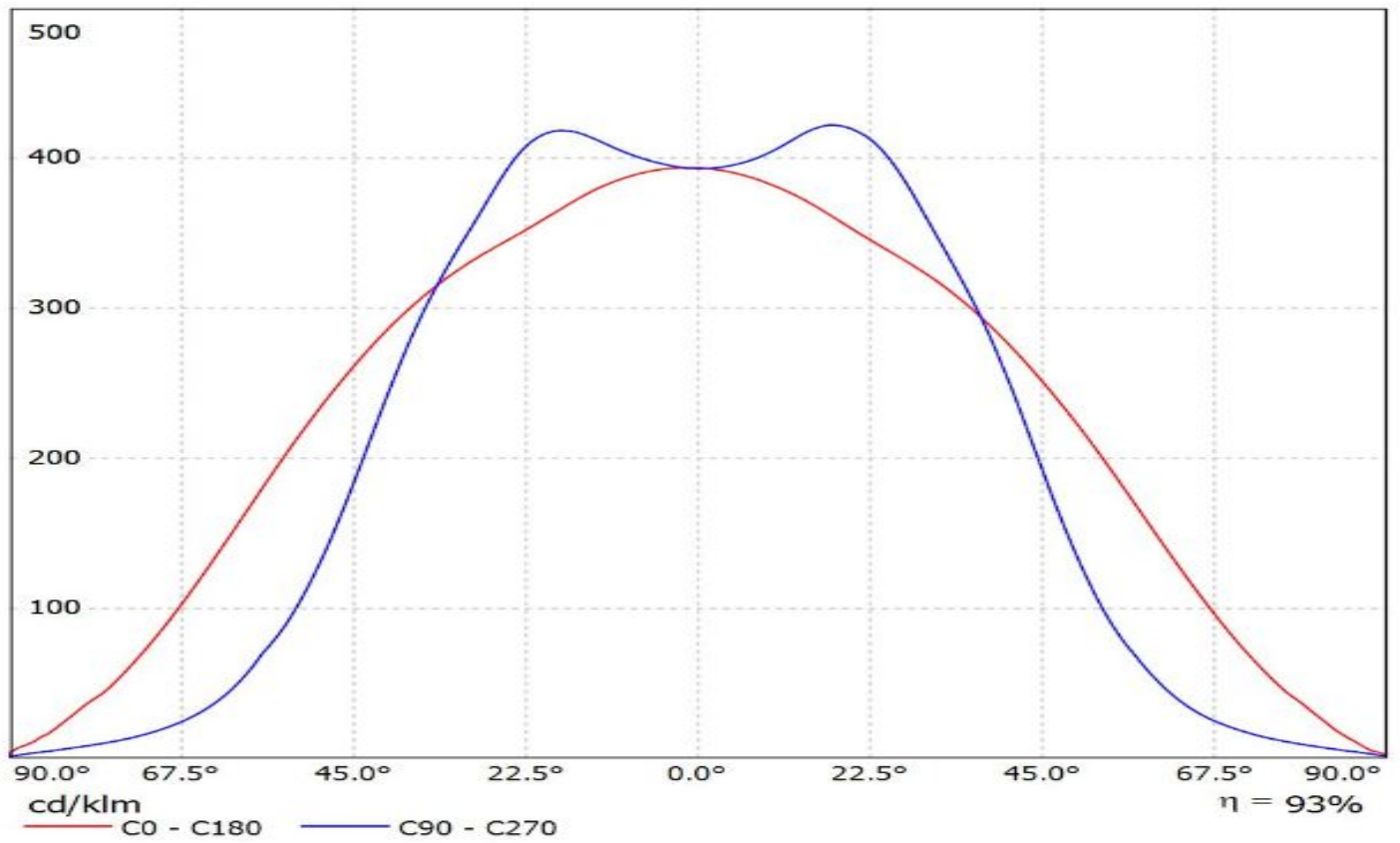

# Ledil F14304\_FLORENCE-1R-Z90\_(NF2x757D) / LDC (Linear)

Luminaire: Ledil F14304\_FLORENCE-1R-Z90\_(NF2x757D)

Lamps: 1 x Nichia\_NF2x757D\_2chip\_x22 (NF2W757DRT)\_2050.61lm@200mA\_P=12.95W\_I=0.2A

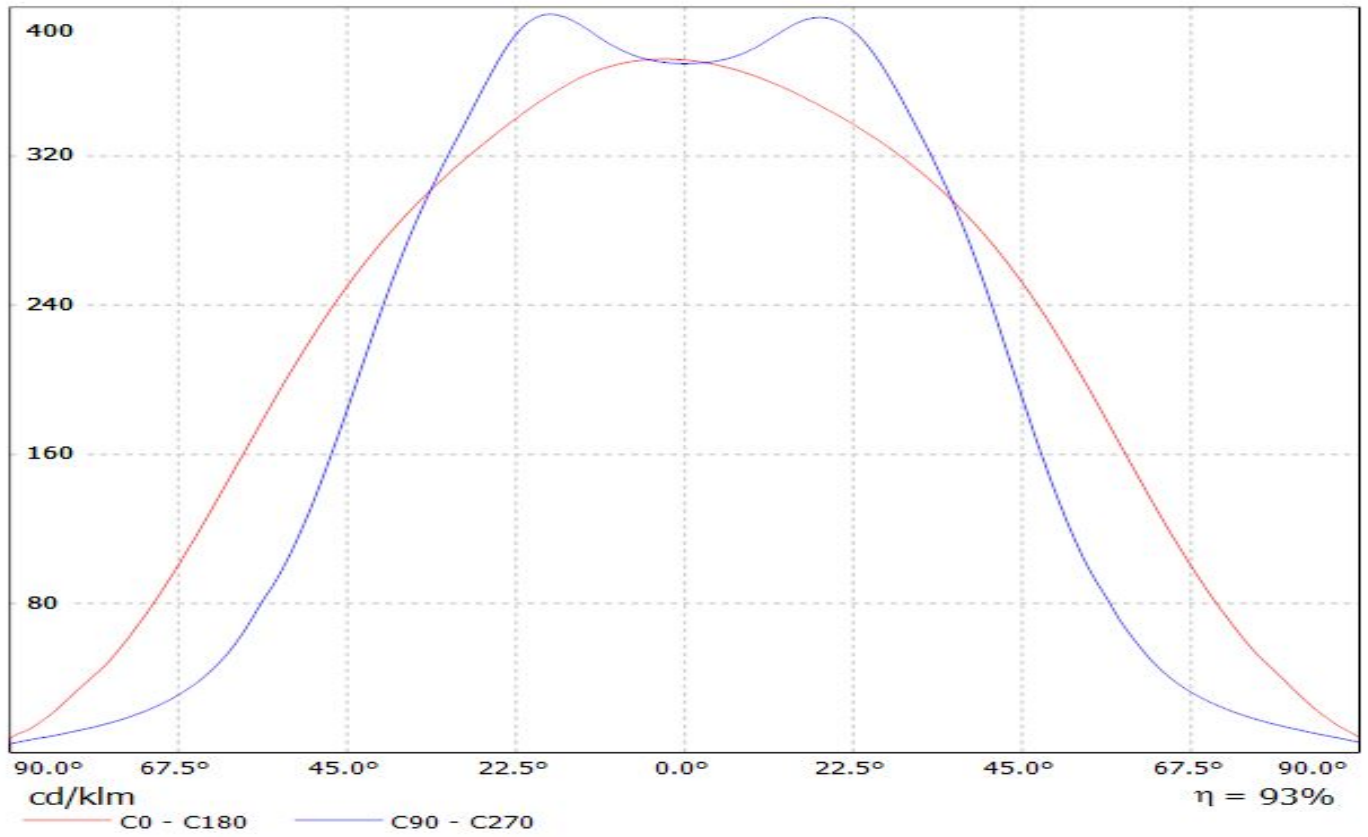

Luminaire: Ledil F14304\_FLORENCE-1R-Z90\_(NF2W757G)  
Lamps: 1 x NF2W757G\_377.885lm@65mA\_CCT=?K\_P=1.97W\_I=0.065A

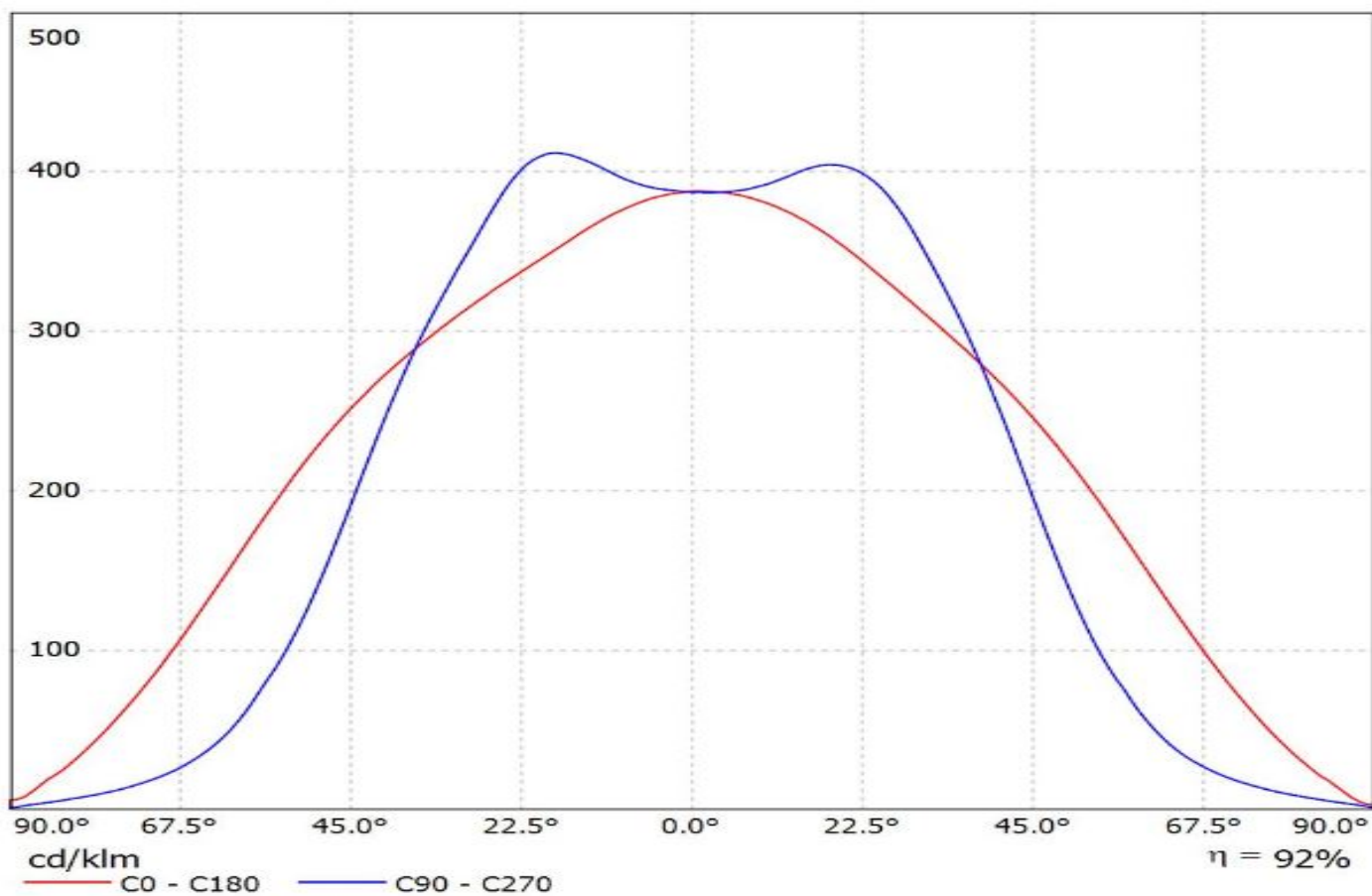

Luminaire: Ledil F14304\_FLORENCE-1R-Z90\_(Duris\_S5)

Lamps: 1 x Osram\_Duris\_S5\_(GW\_PSLRS1.ÉC-LQLS-5H7I-1)\_993.467lm@100mA\_P=8W\_I=0.1000A

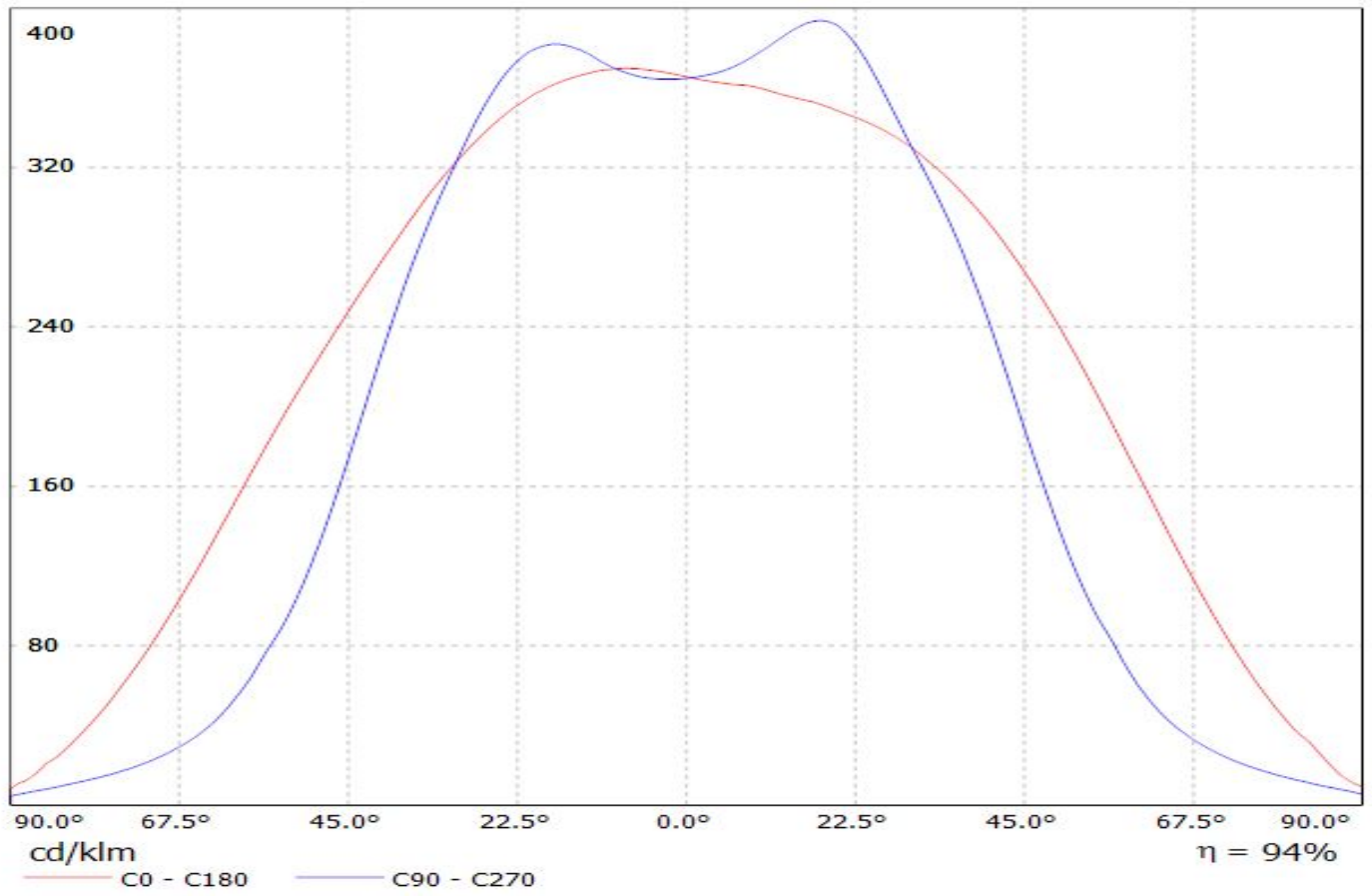

Luminaire: Ledil Oy F14304\_FLORENCE-1R-Z90\_(Duris\_E\_2835)\_SIMULATED  
Lamps: 1 x Osram Duris E 2835 - GW JTLRS1.EM

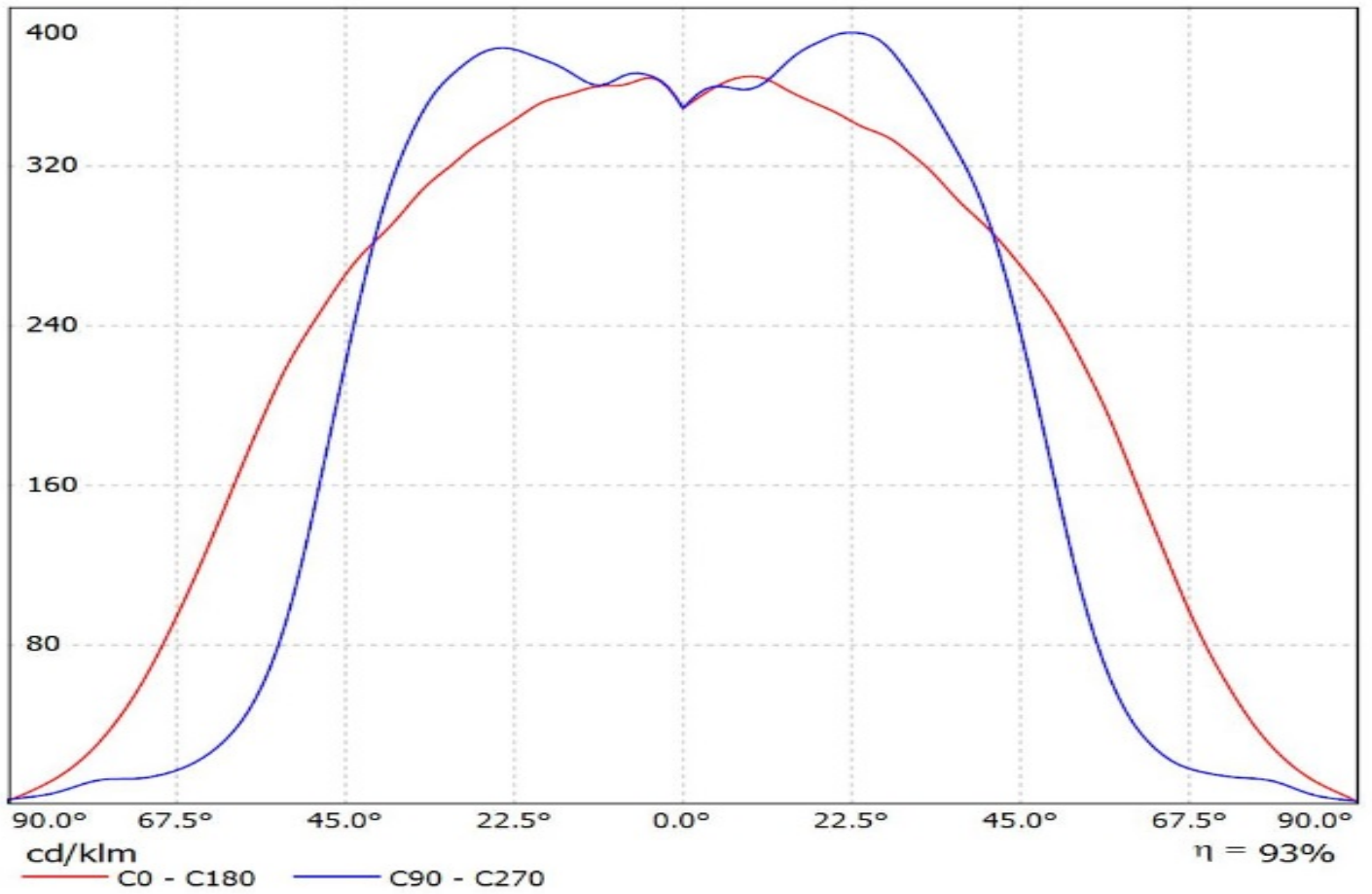

Luminaire: LEDiL Oy F14304\_FLORENCE-1R-Z90

Lamps: 1 x Fortimo LED Line 1ft 1100lm 1R\_1033.71lm@250mA\_P=8.41851W\_I=249.8mA

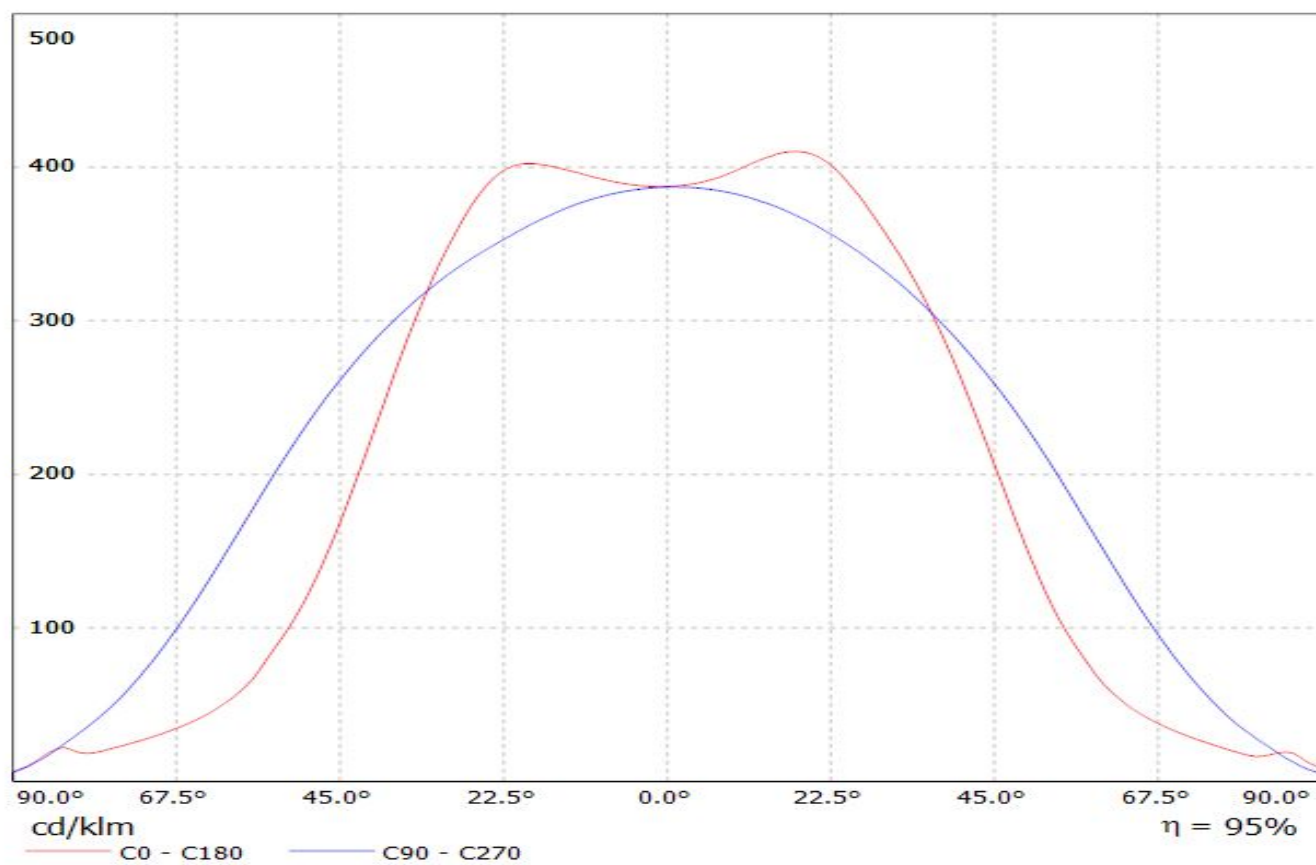



Luminaire: LEDiL Oy F14304\_FLORENCE-1R-Z90\_(LM302A)

Lamps: 1 x Samsung\_LM302A\_865.46lm@100mA\_P=6.64694W\_I=0.1001A

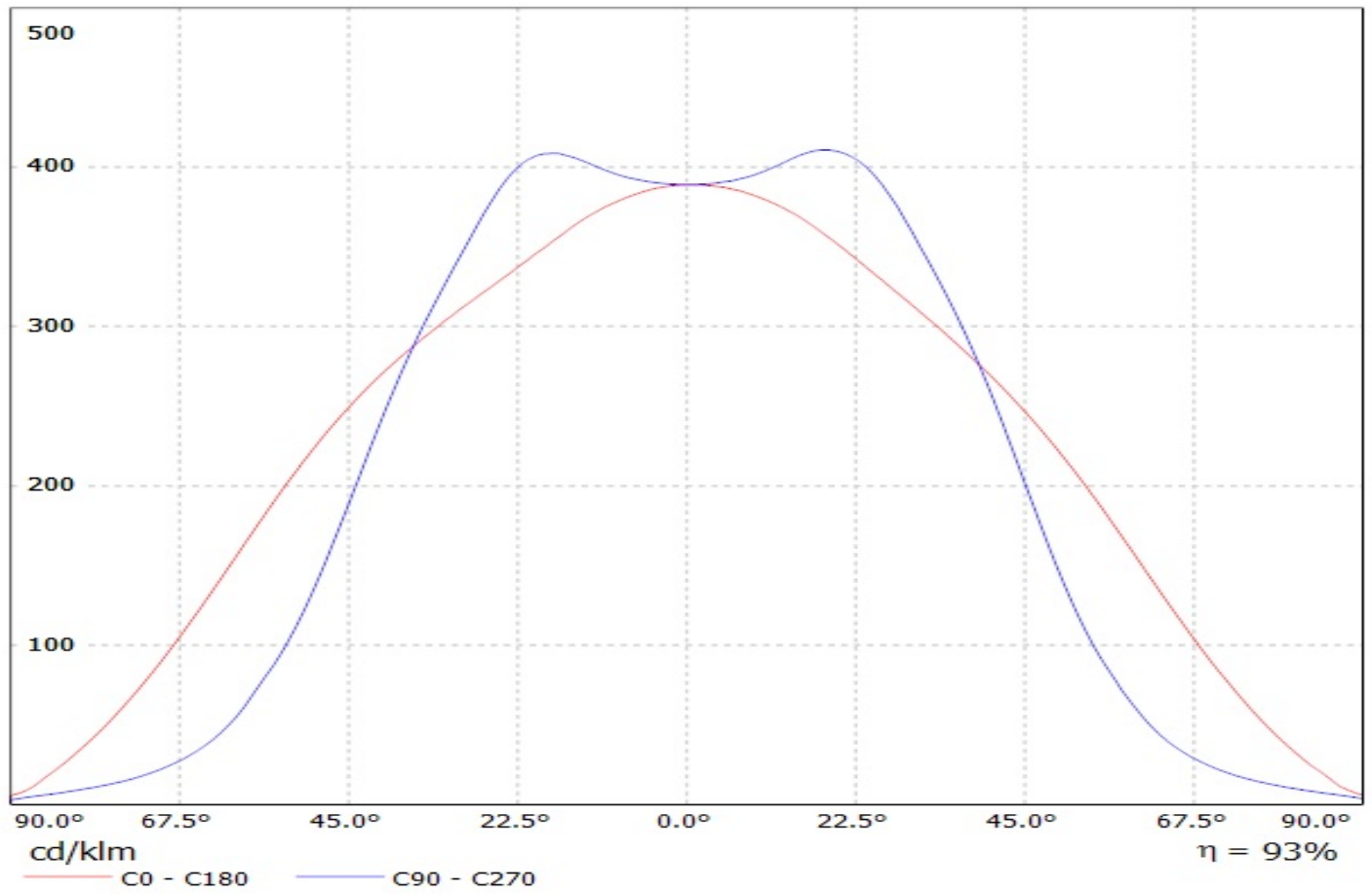

# Ledil F14304\_FLORENCE-1R-Z90\_(LM561B) / LDC (Linear)

Luminaire: Ledil F14304\_FLORENCE-1R-Z90\_(LM561B)

Lamps: 1 x Samsung\_LM561B\_x22\_348.84lm@65mA\_P=1.97W\_I=65mA

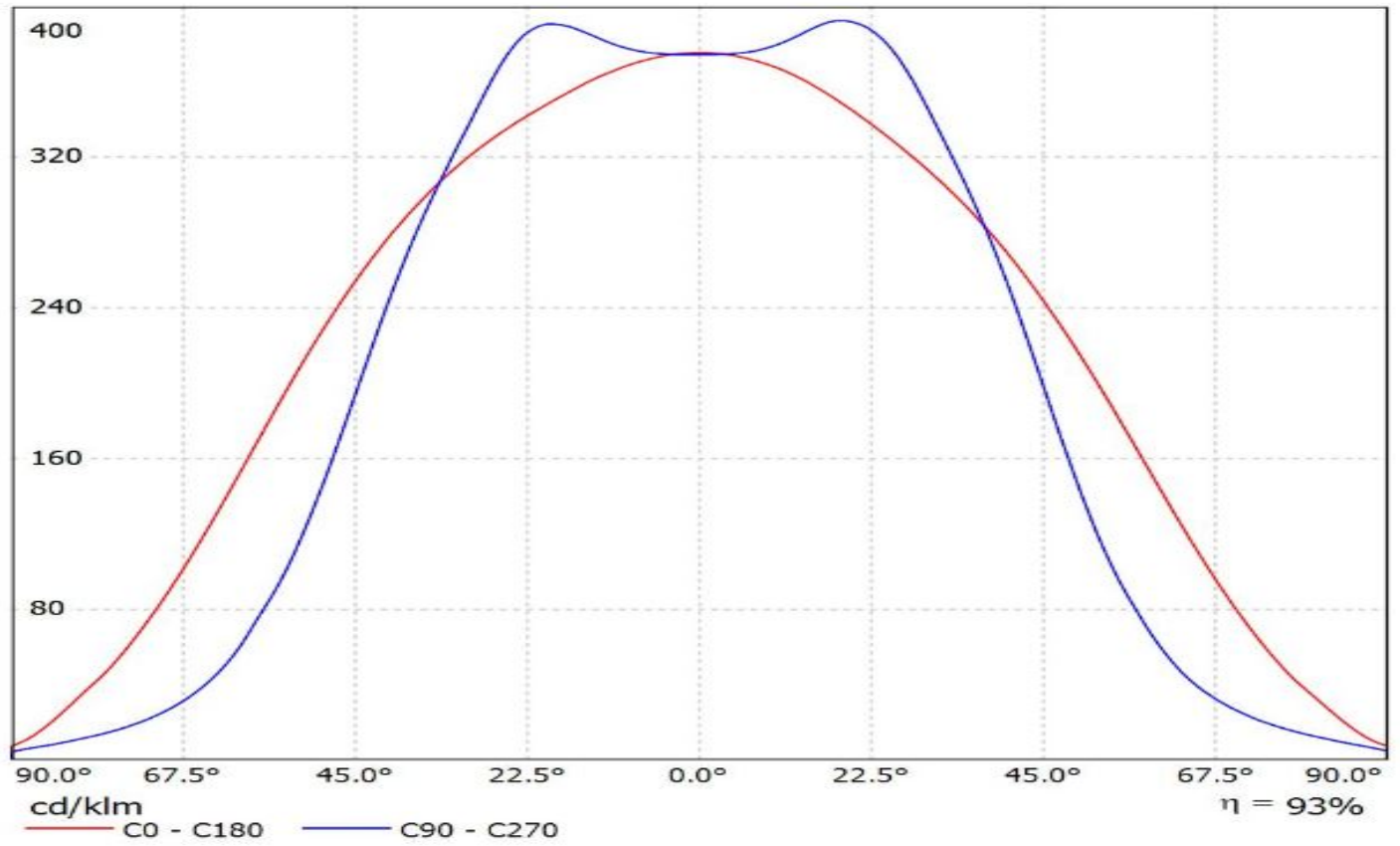

Luminaire: Ledil F14304\_FLORENCE-1R-Z90\_(LM301A)

Lamps: 1 x Samsung\_LM301A\_x11\_(SPMWHT328FD5WAT0S0)\_1087.4lm@250mA\_P=8.1922W\_I=0.25A

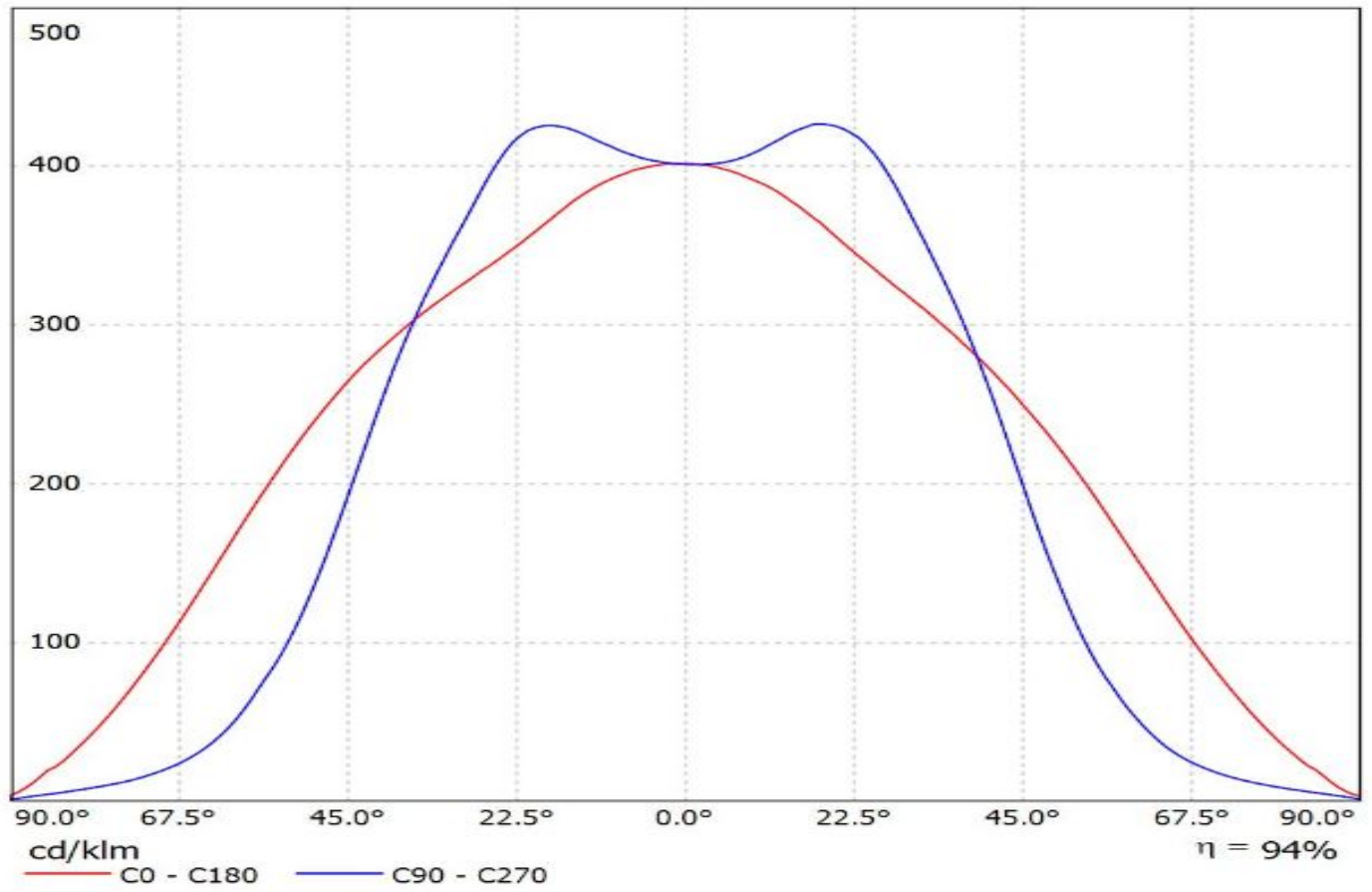

Luminaire: Ledil F14304\_FLORENCE-1R-Z90\_(LT-S282N)

Lamps: 1 x Samsung SI-B8T071280LD\_LM5618+\_1401.55lm@250mA\_P=9.185W\_I=0.25A

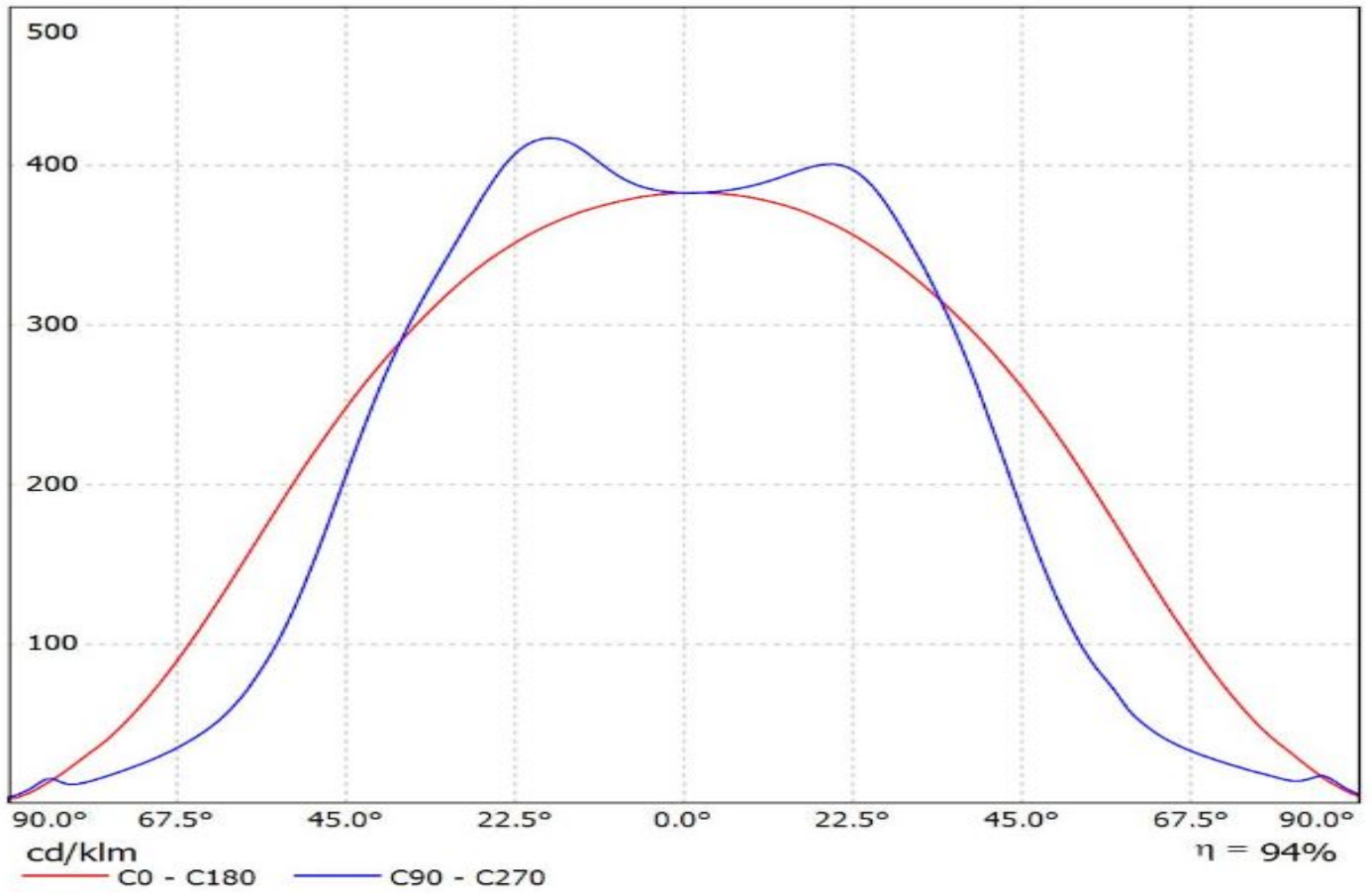

Luminaire: LEDiL Oy F14304\_FLORENCE-1R-Z90\_(LM561C)  
Lamps: 1 x Samsung\_LM561C\_688.201lm@130mA\_P=3.9390W\_I=0.130A

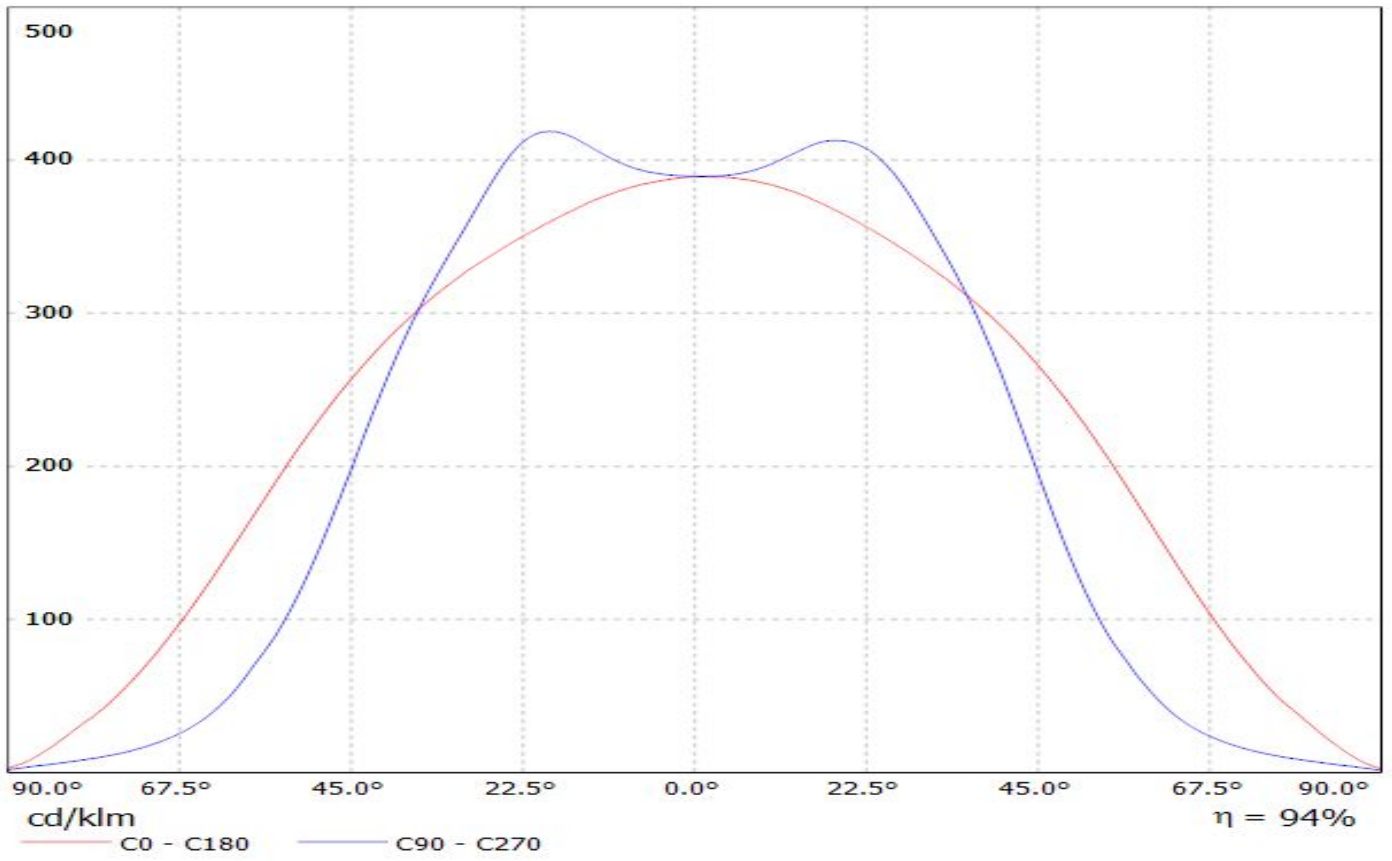

Luminaire: LEDiL Oy F14304\_FLORENCE-1R-Z90\_(LM281B)  
Lamps: 1 x Samsung\_LM281B\_1309.14lm@300mA\_P=10.244W\_I=0.300A

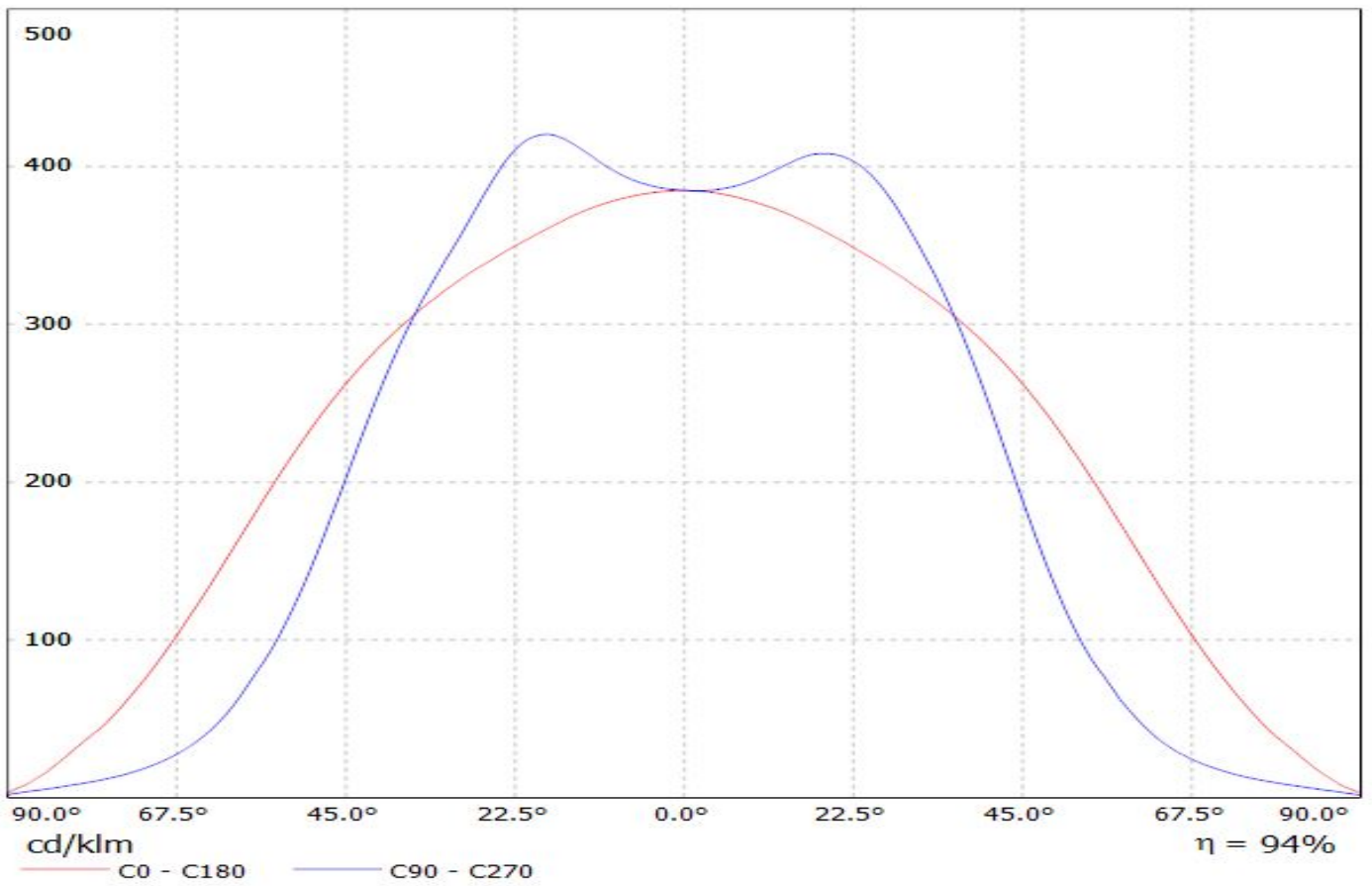

# Ledil F14304\_FLORENCE-1R-Z90\_(Seoul\_3030) / LDC (Linear)

Luminaire: Ledil F14304\_FLORENCE-1R-Z90\_(Seoul\_3030)

Lamps: 1 x Seoul\_3030\_x11\_(STW8C2SA)\_785.296lm@100mA\_P=6.5W\_I=0.1A

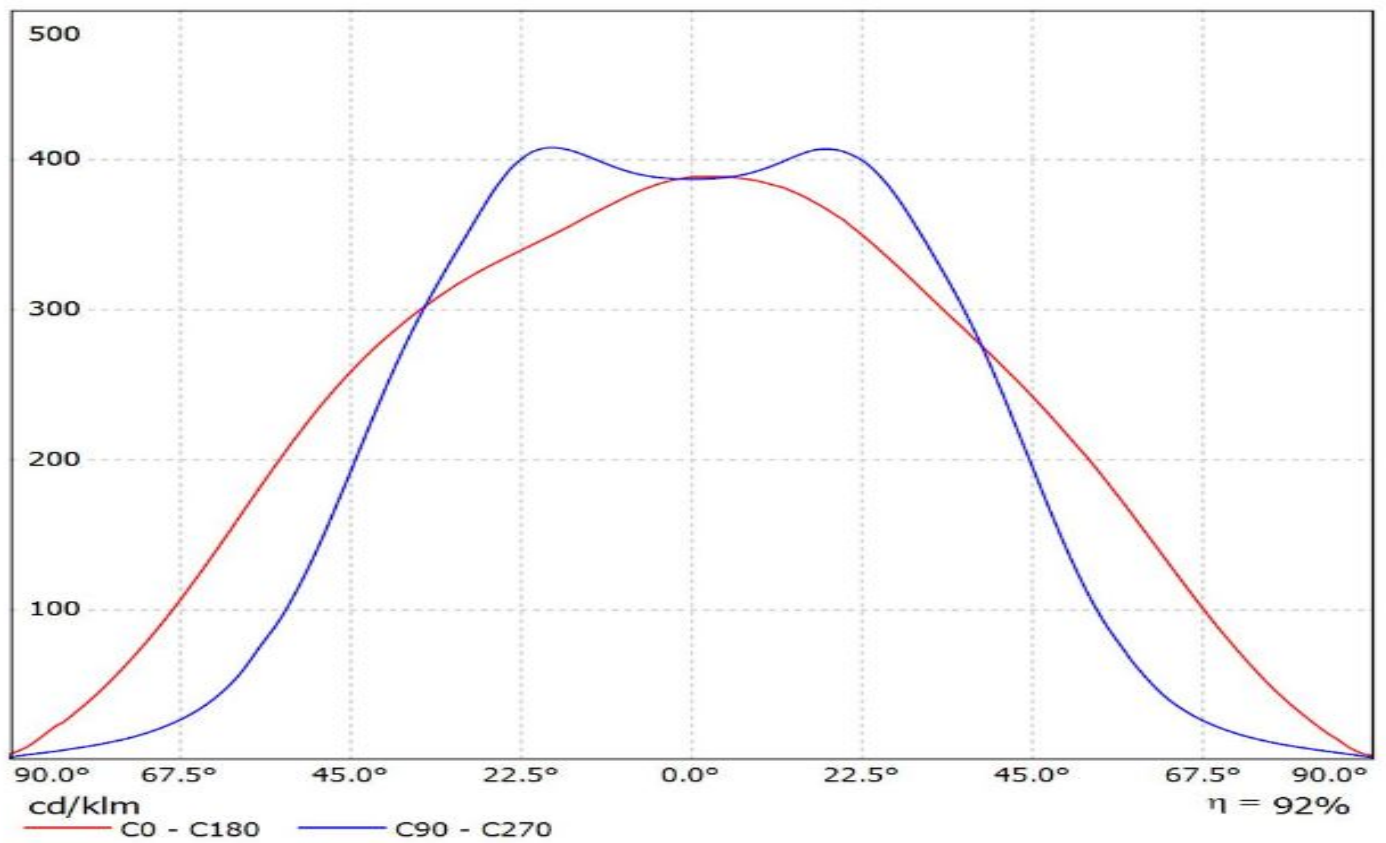

Luminaire: Ledil F14304\_FLORENCE-1R-Z90\_(SunLike\_3030)

Lamps: 1 x SEOUL\_SunLike\_3030\_(STW9C2PB-S)\_2\_240.649lm@0.65mA\_P=2.30531W\_U=35.538V

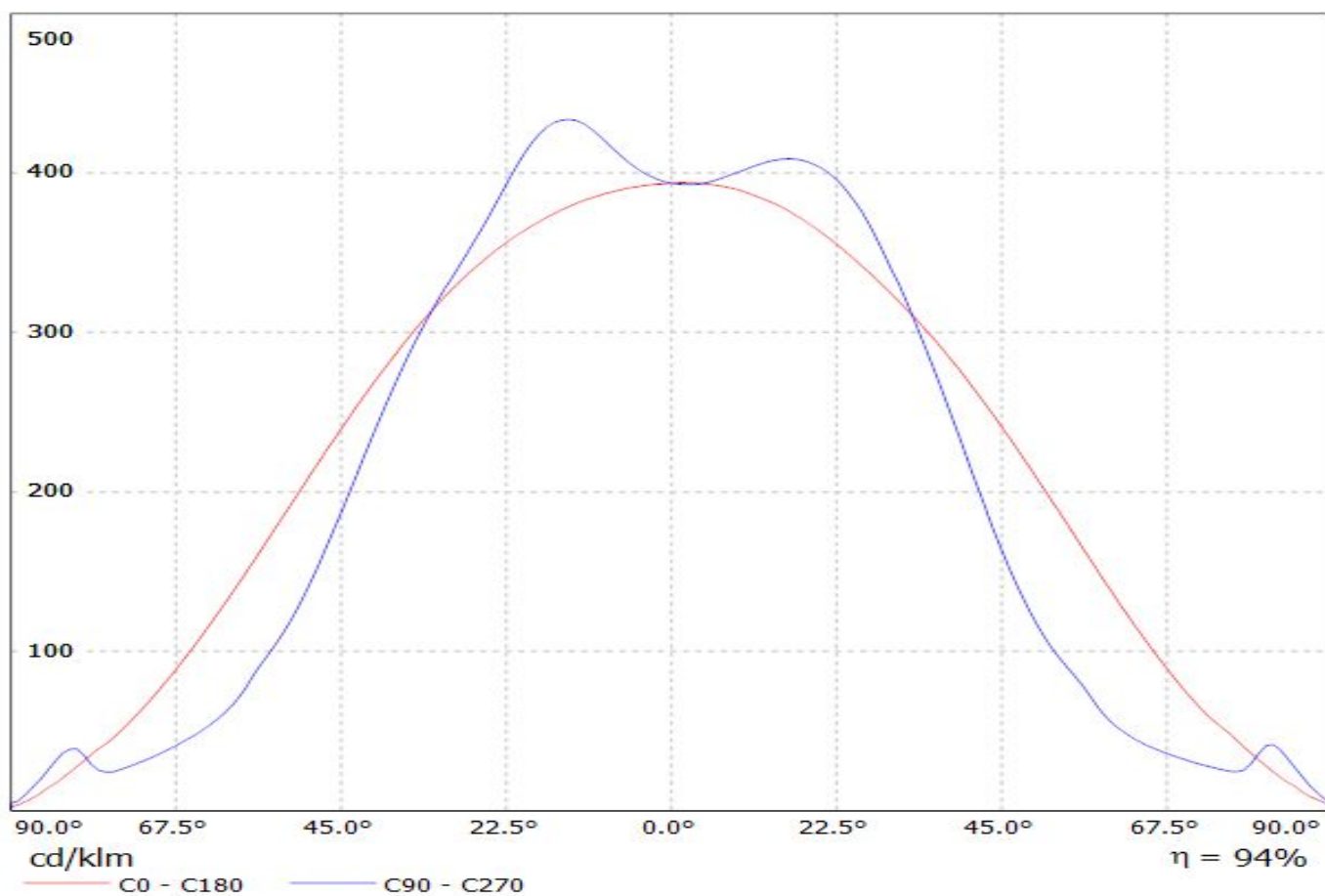



Luminaire: Ledil F14304\_FLORENCE-1R-Z90\_(CALGD0414-M8W1)  
Lamps: 1 x Citizen\_CALGD0414-M8W1\_556.672lm@350mA\_P=4.0291W\_I=0.3499A

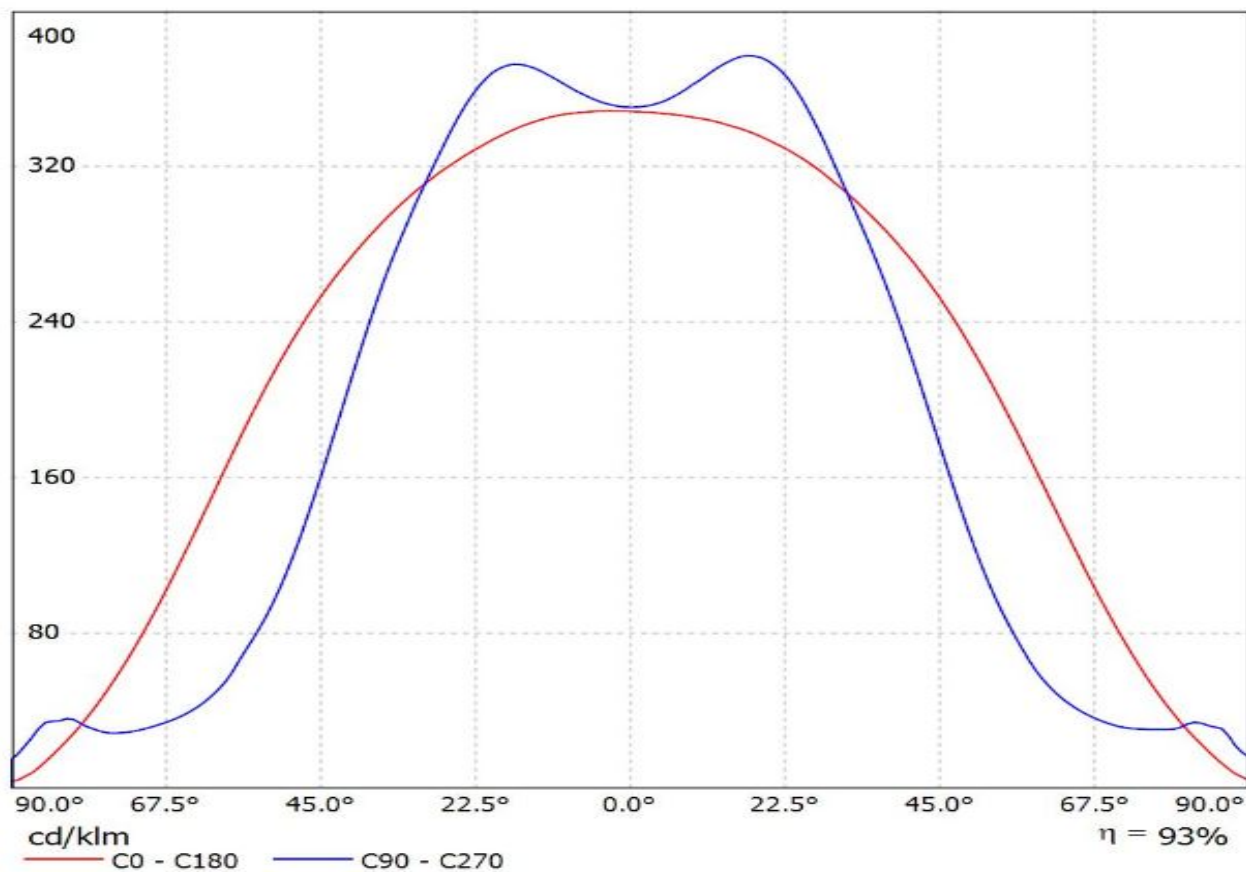

Luminaire: Ledil F14304\_FLORENCE-1R-Z90\_(CALGD0814-M17W1)  
Lamps: 1 x Citizen\_(CALGD0814-M17W1)\_1098.26lm@350mA\_P=7.96302W\_η=0.3499A

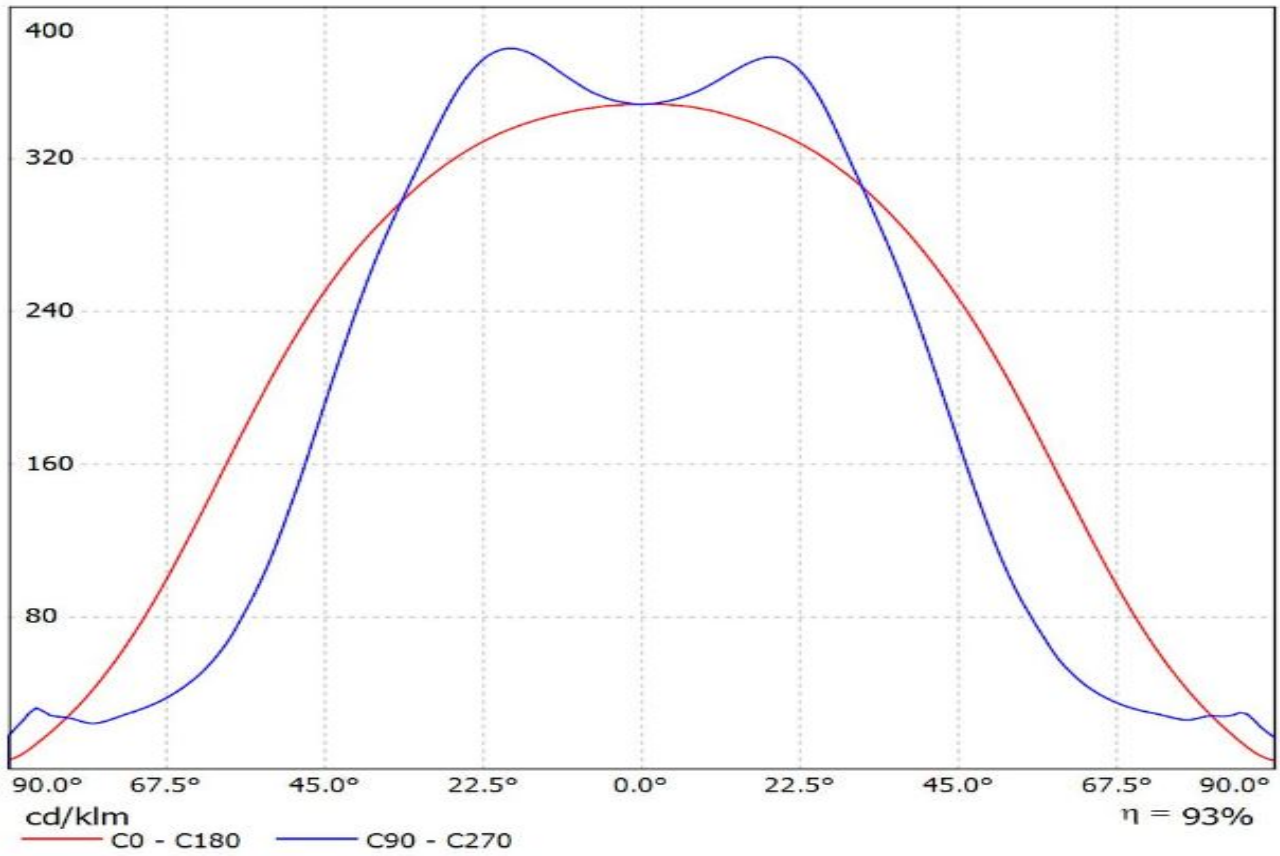

Luminaire: Ledil F14304\_FLORENCE-1R-Z90\_(CeZos)

Lamps: 1 x CeZos\_(L0-280024-xxx-C0800-L267)\_1346.29lm@250mA\_CCT=3000K\_P=8.5017W\_I=0.25A

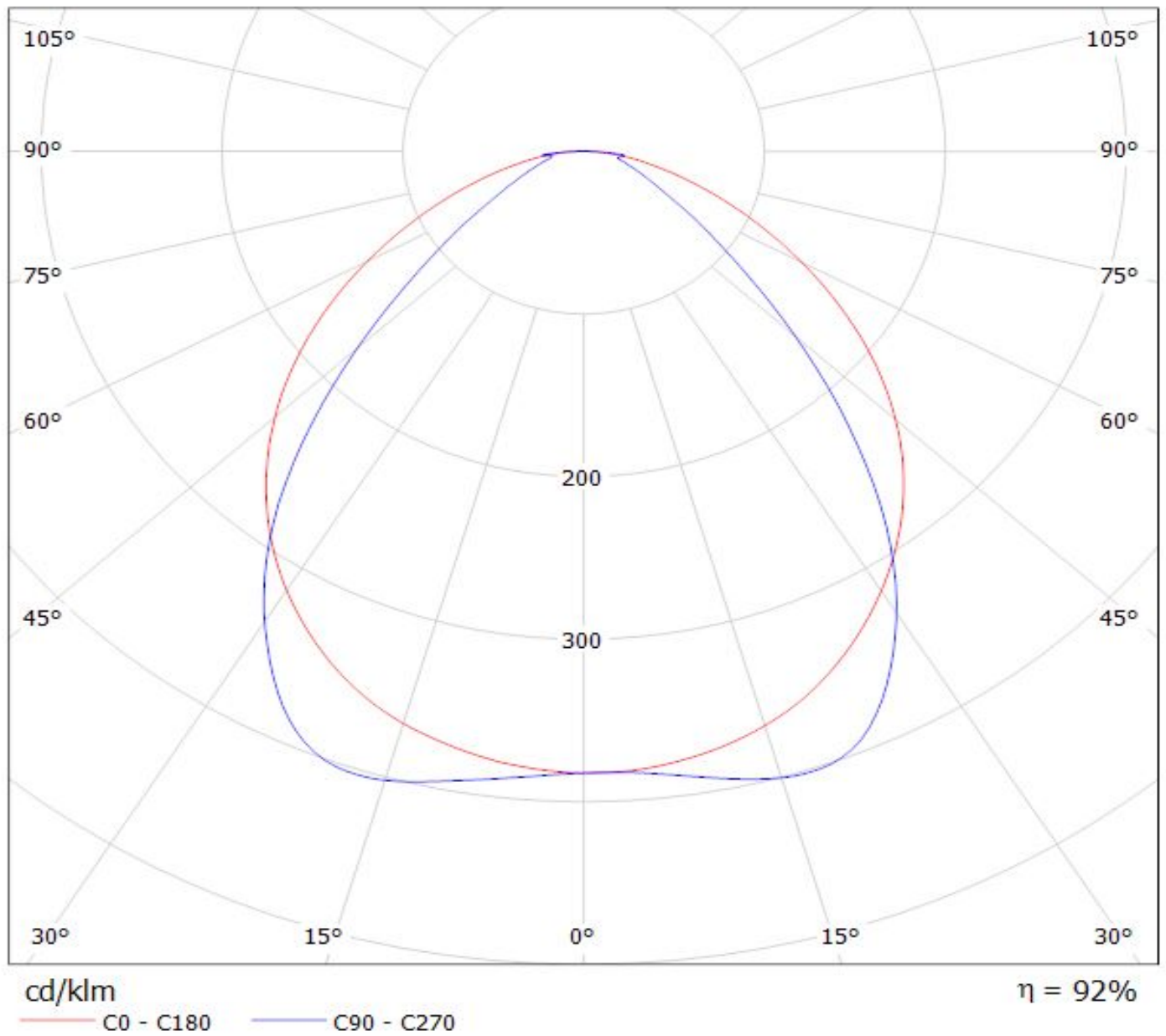

# Ledil F14304\_FLORENCE-1R-Z90\_(XH-B) / LDC (Polar)

Luminaire: Ledil F14304\_FLORENCE-1R-Z90\_(XH-B)

Lamps: 1 x Cree\_XH-B\_x22\_(XHBAAWT-0-7B4-J20-0H-0001)\_315.848lm@65mA\_P=2.11W\_I=65mA

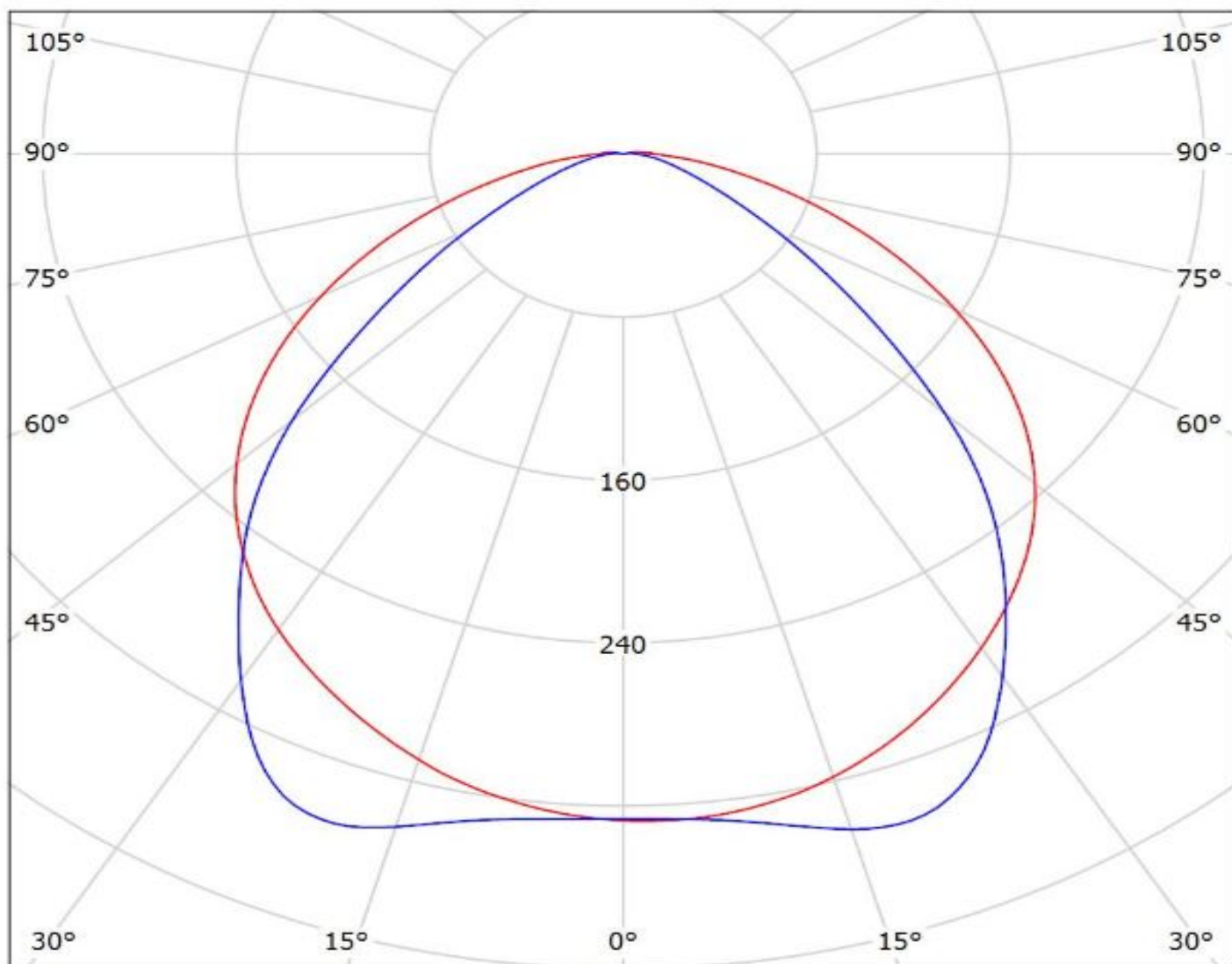

cd/klm

— C0 - C180 — C90 - C270

$\eta = 90\%$

# Ledil F14304\_FLORENCE-1R-Z90\_(Luxeon\_3535\_2D) / LDC (Polar)

Luminaire: Ledil F14304\_FLORENCE-1R-Z90\_(Luxeon\_3535\_2D)

Lamps: 1 x Luxeon\_3535\_2D\_x22\_(MXC8\_4000K)\_910.245lm@100mA\_CCT=4000K\_P=6.32W\_I=0.1A

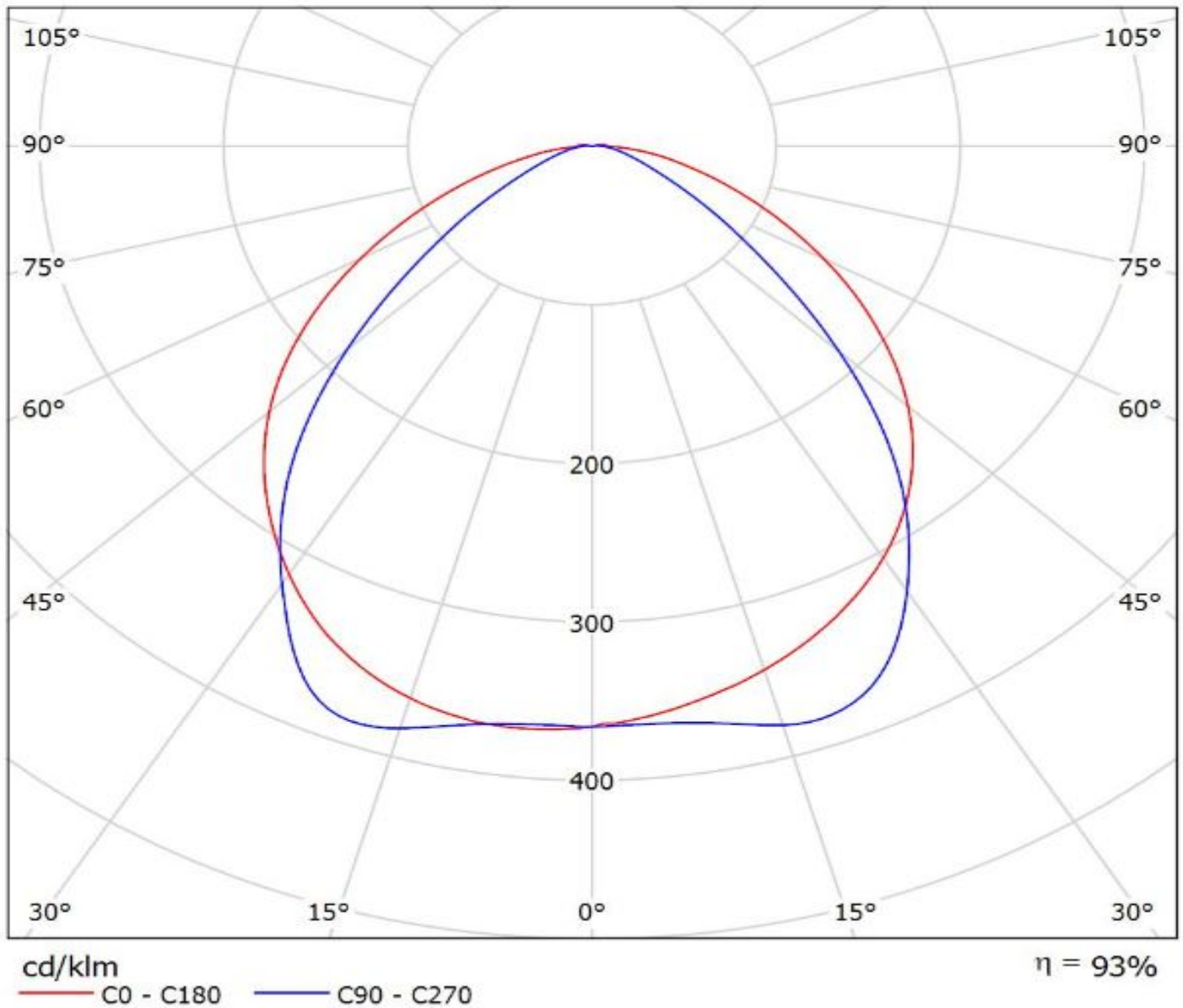

# Ledil F14304\_FLORENCE-1R-Z90\_(Luxeon\_3030\_2D) / LDC (Polar)

Luminaire: Ledil F14304\_FLORENCE-1R-Z90\_(Luxeon\_3030\_2D)

Lamps: 1 x Luxeon\_3030\_2D\_x22\_(L130-4080003000W21)

\_1601.44lm@200mA\_CCT=4000K\_P=12.8W\_I=0.2A

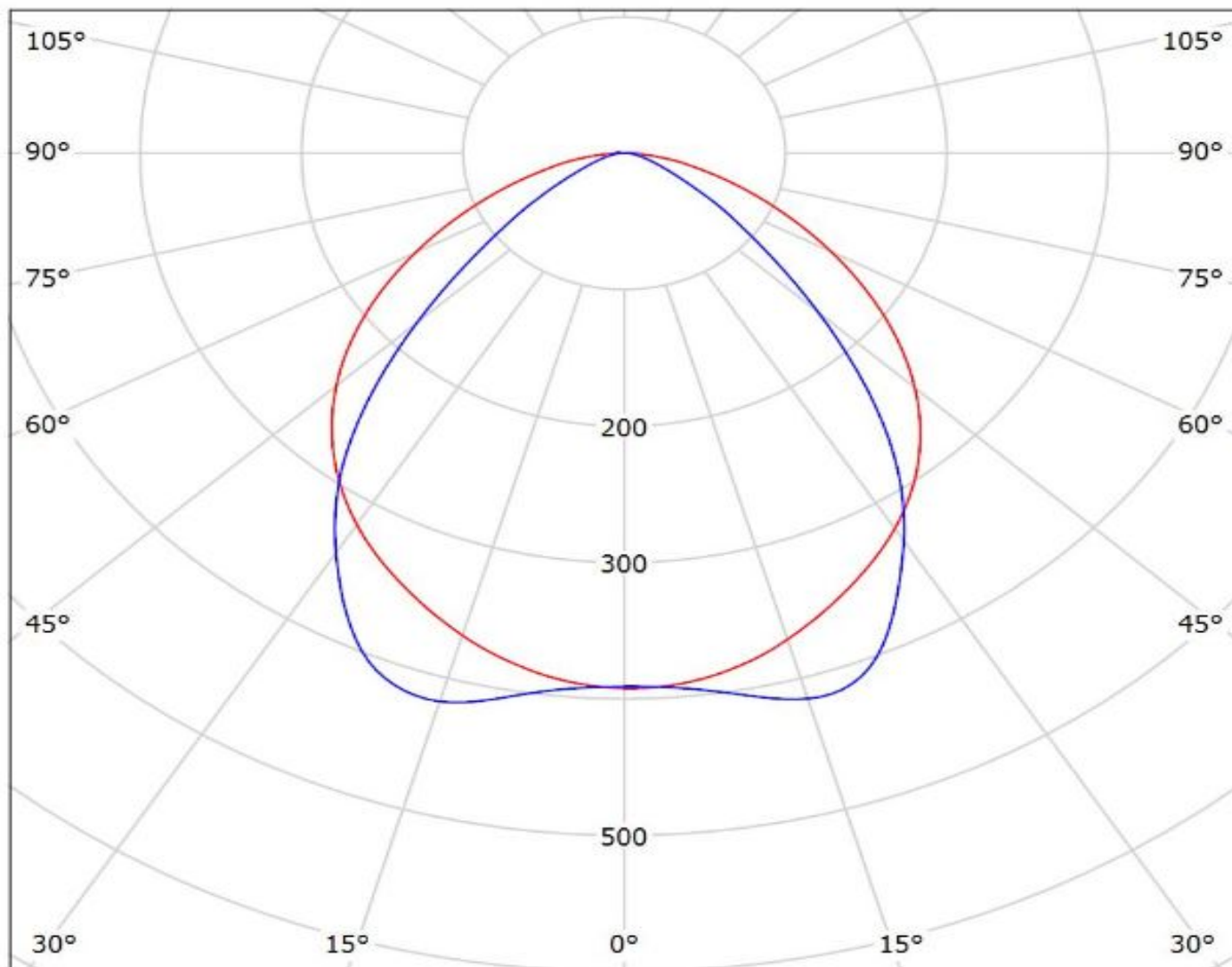

cd/klm

— C0 - C180 — C90 - C270

$\eta = 92\%$

Luminaire: Ledil F14304\_FLORENCE-1R-Z90\_(3014\_x22)

Lamps: 1 x Luxeon\_3014\_x22\_(L130-5080)\_282.652lm@60mA\_P=1.9076W\_I=0.060mA

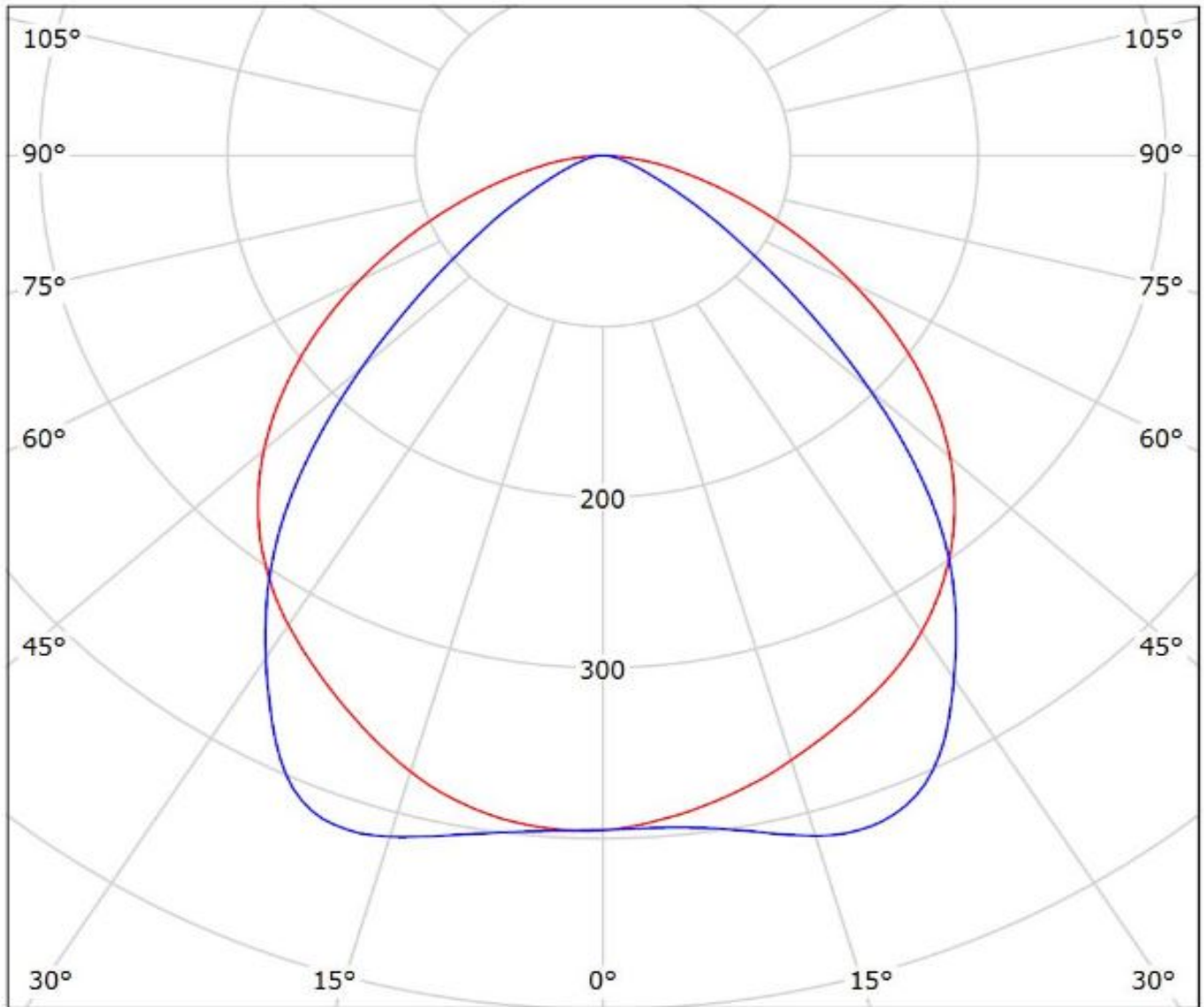

cd/klm

— C0 - C180 — C90 - C270

$\eta = 94\%$

Luminaire: Ledil F14304\_FLORENCE-1R-Z90\_(3535L\_x22)

Lamps: 1 x Luxeon\_3535L\_x22\_(MXA8-PW50)\_507.681lm@100mA\_P=2.9953W\_I=0.100mA

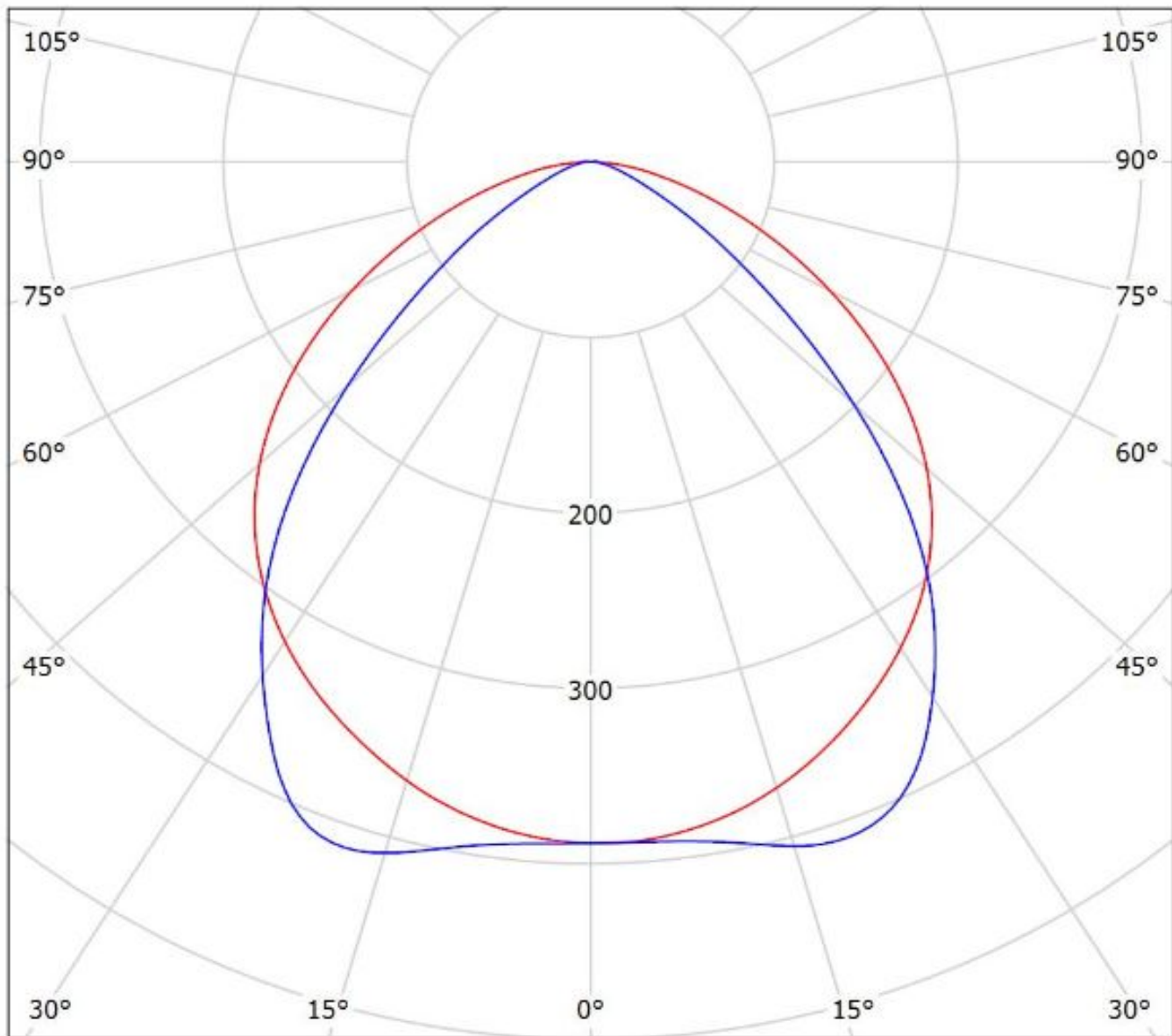

cd/klm

— C0 - C180 — C90 - C270

$\eta = 94\%$



Luminaire: Ledil F14304\_FLORENCE-1R-Z90\_(3020)

Lamps: 1 x Luxeon\_3020\_x22\_(L130-2780)\_488.066lm@120mA\_P=3.7731W\_I=0.120mA

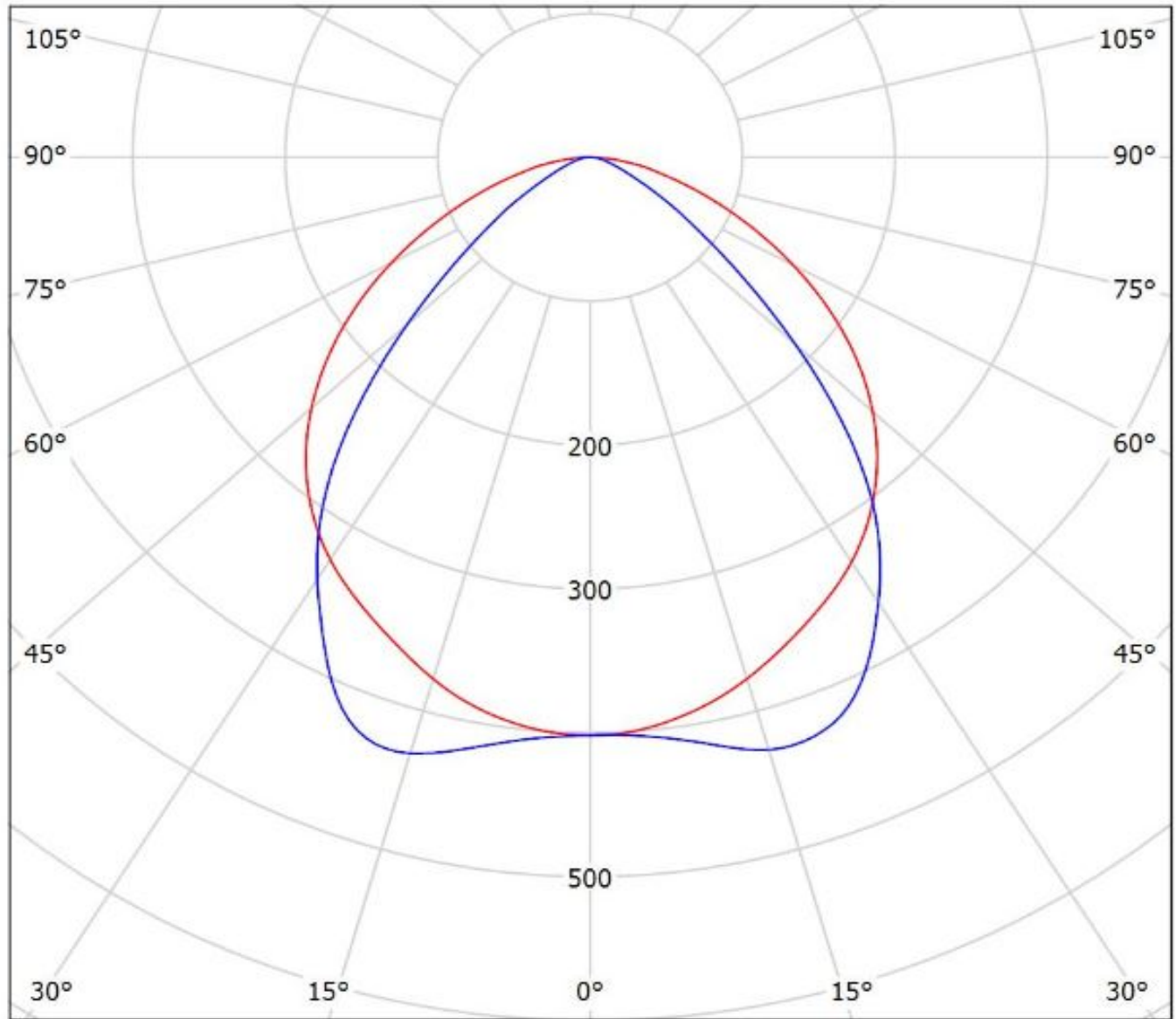

cd/klm

— C0 - C180 — C90 - C270

$\eta = 94\%$

# Ledil F14304\_FLORENCE-1R-Z90\_(Luminus\_MP-2016) / LDC (Polar)

Luminaire: Ledil F14304\_FLORENCE-1R-Z90\_(Luminus\_MP-2016)

Lamps: 1 x Luminus\_MP-2016\_1x22\_(LUMMP-1100-30-80)\_471.904lm@120mA\_P=4W\_η=0.12A

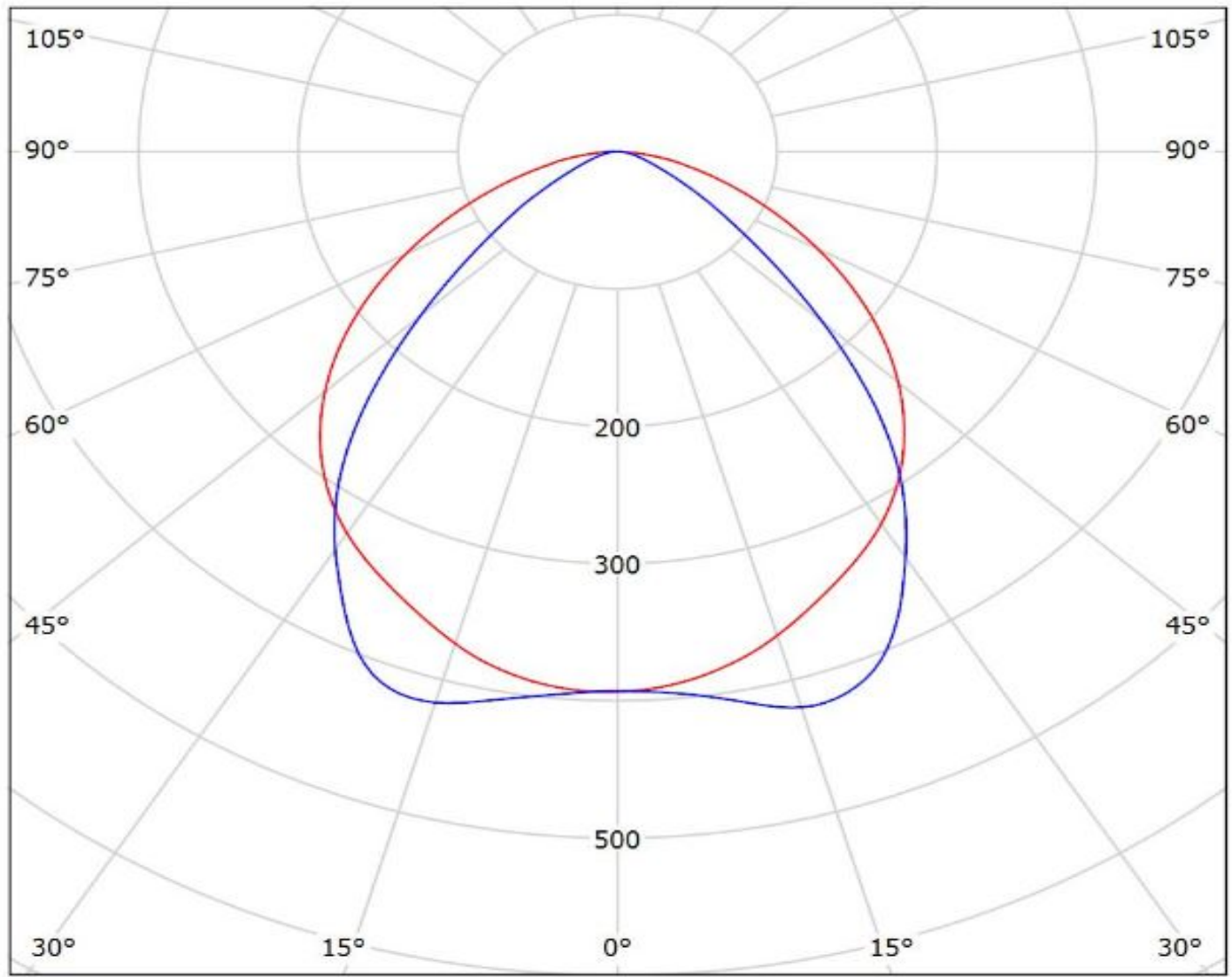

cd/klm

— C0 - C180

— C90 - C270

η = 93%

# Ledil F14304\_FLORENCE-1R-Z90\_(NF2x757D) / LDC (Polar)

Luminaire: Ledil F14304\_FLORENCE-1R-Z90\_(NF2x757D)

Lamps: 1 x Nichia\_NF2x757D\_2chip\_x22 (NF2W757DRT)\_2050.61lm@200mA\_P=12.95W\_I=0.2A

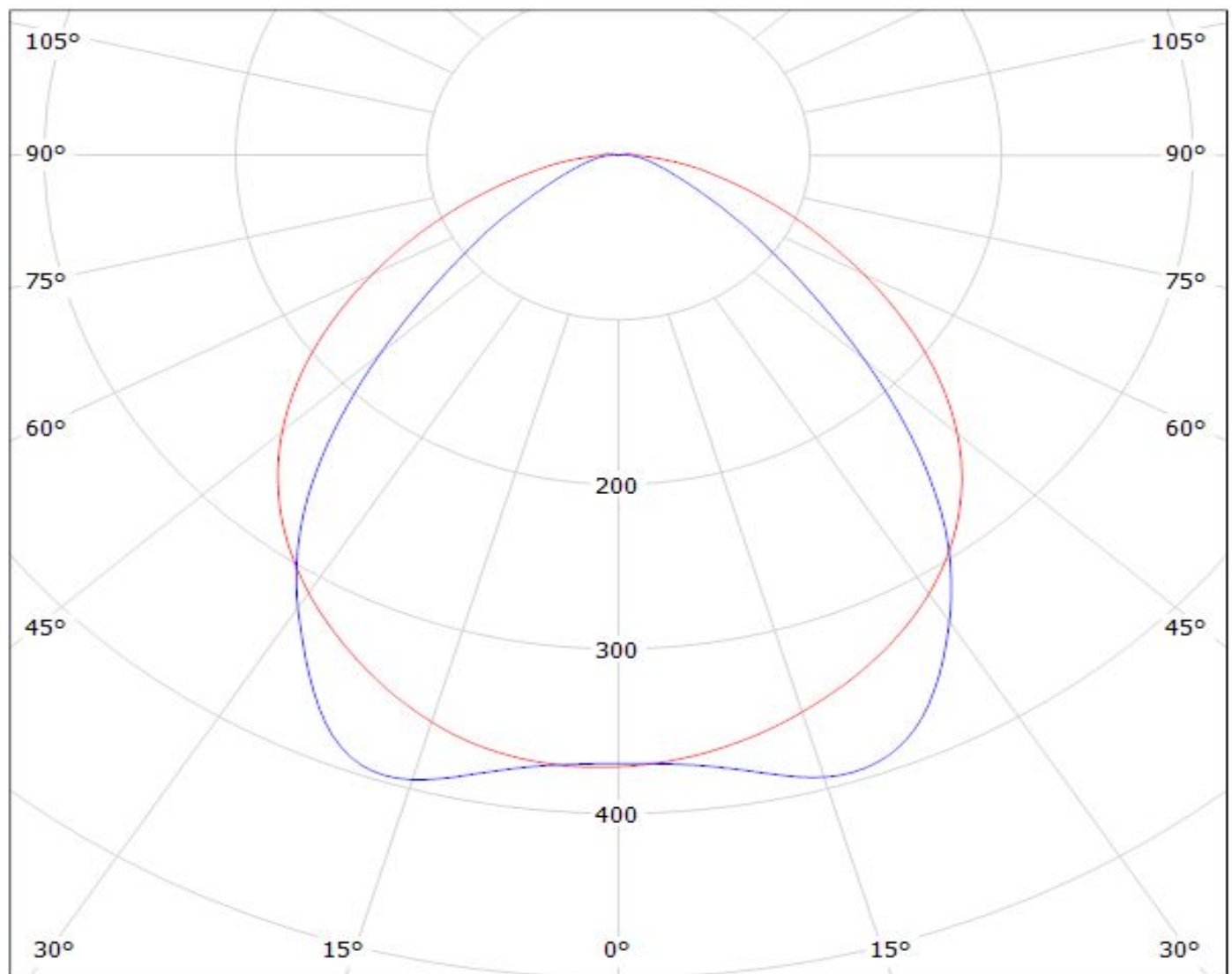

cd/klm

— C0 - C180

— C90 - C270

$\eta = 93\%$

Luminaire: Ledil F14304\_FLORENCE-1R-Z90\_(NF2W757G)

Lamps: 1 x NF2W757G\_377.885lm@65mA\_CCT=?K\_P=1.97W\_I=0.065A

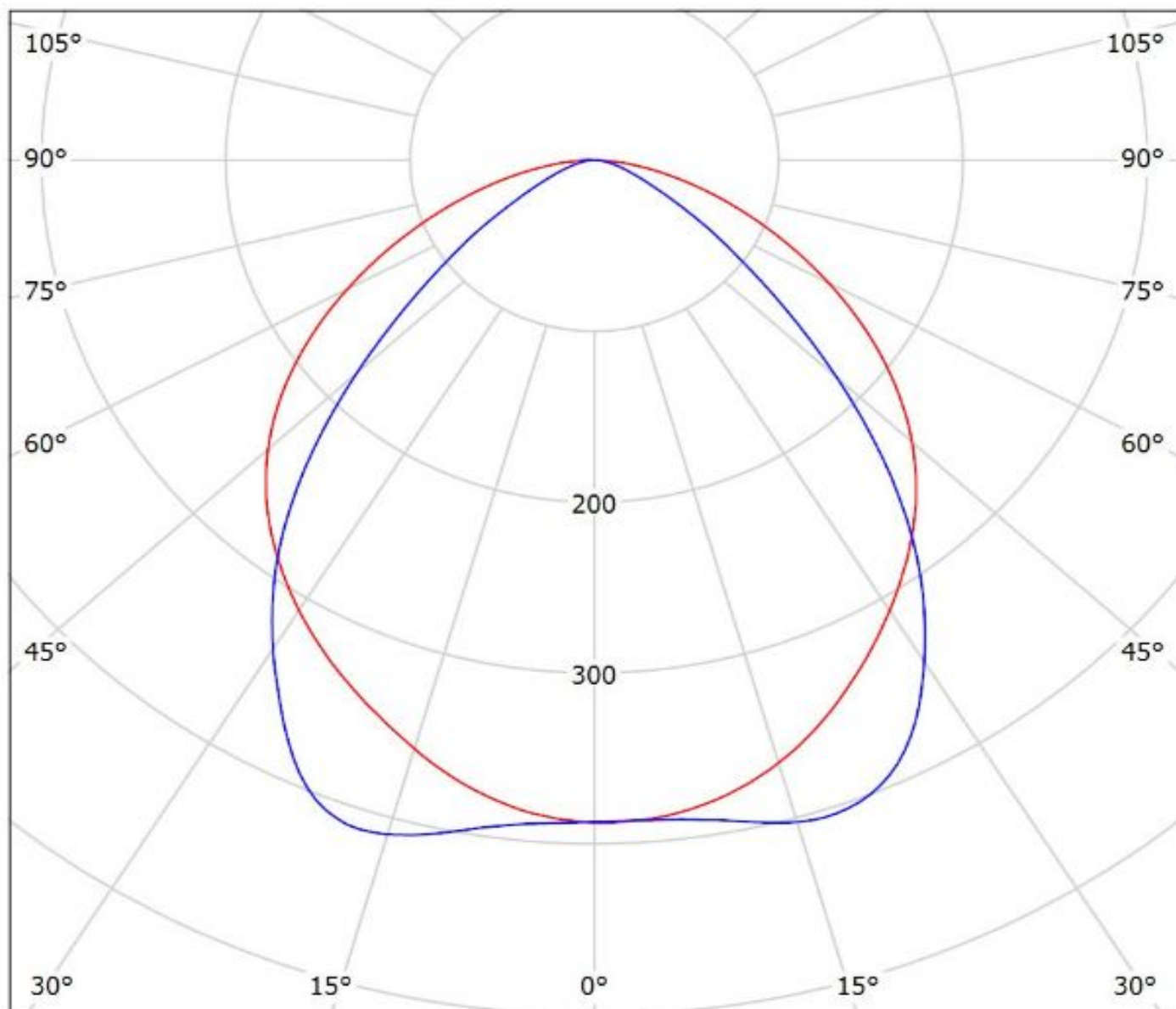

cd/klm

— C0 - C180 — C90 - C270

$\eta = 92\%$

Luminaire: Ledil F14304\_FLORENCE-1R-Z90\_(Duris\_S5)

Lamps: 1 x Osram\_Duris\_S5\_(GW\_PSLRS1.EC-LQLS-5H7I-1)\_993.467lm@100mA\_P=8W\_I=0.1000A

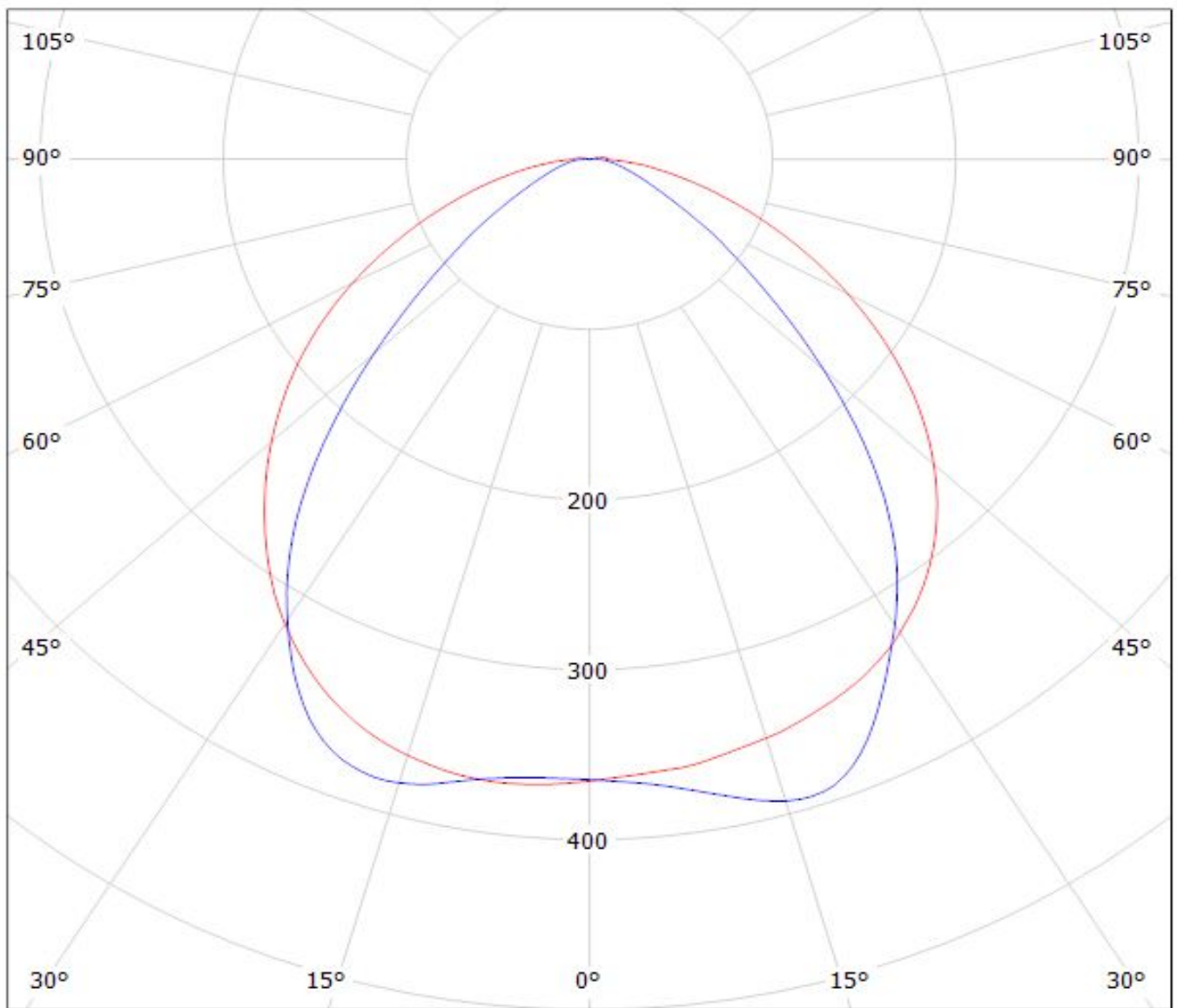

cd/klm

$\eta = 94\%$

— C0 - C180

— C90 - C270

Luminaire: Ledil Oy F14304\_FLORENCE-1R-Z90\_(Duris\_E\_2835)\_SIMULATED  
Lamps: 1 x Osram Duris E 2835 - GW JTLRS1.EM

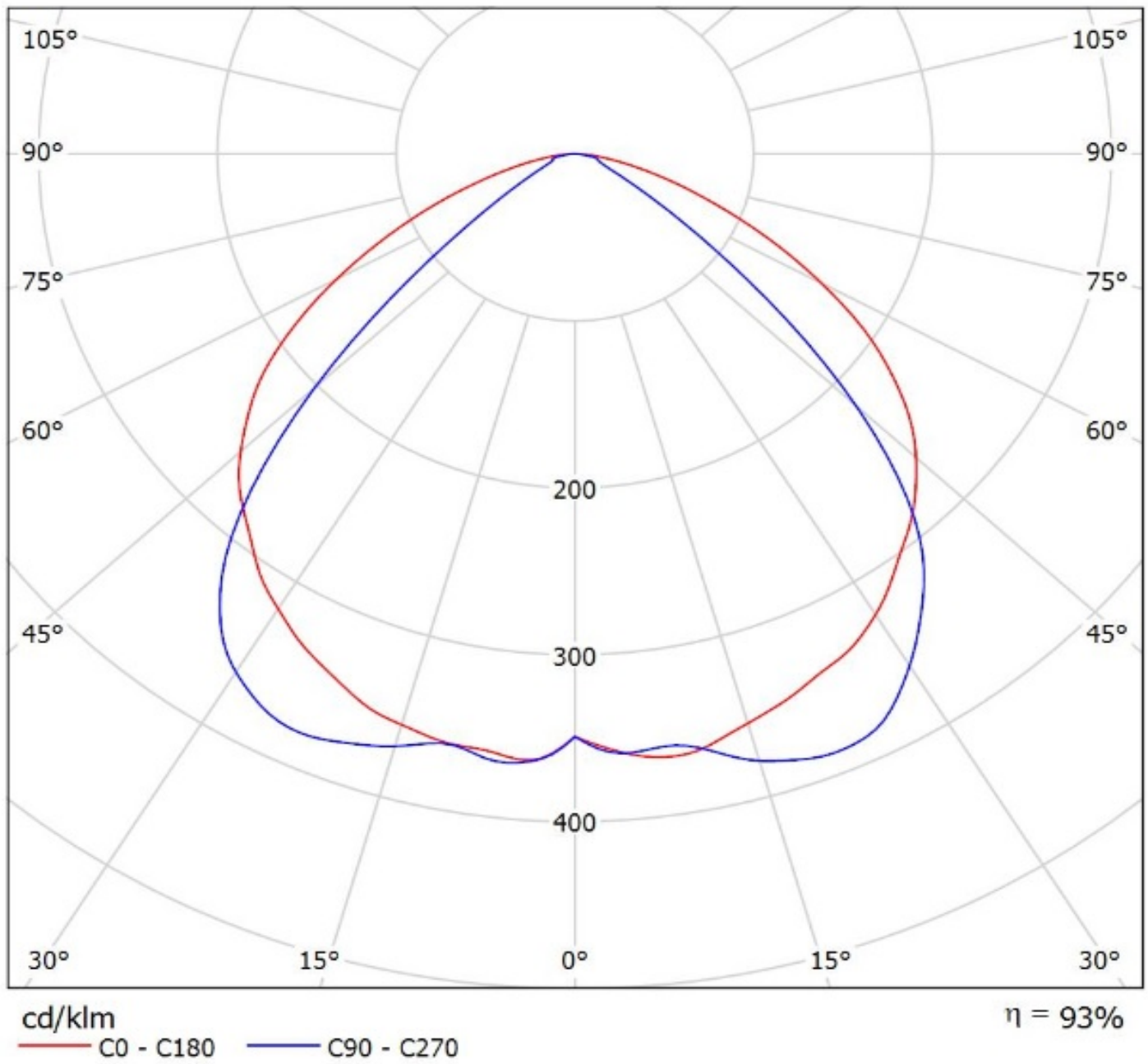

Luminaire: LEDiL Oy F14304\_FLORENCE-1R-Z90

Lamps: 1 x Fortimo LED Line 1ft 1100lm 1R\_1033.71lm@250mA\_P=8.41851W\_I=249.8mA

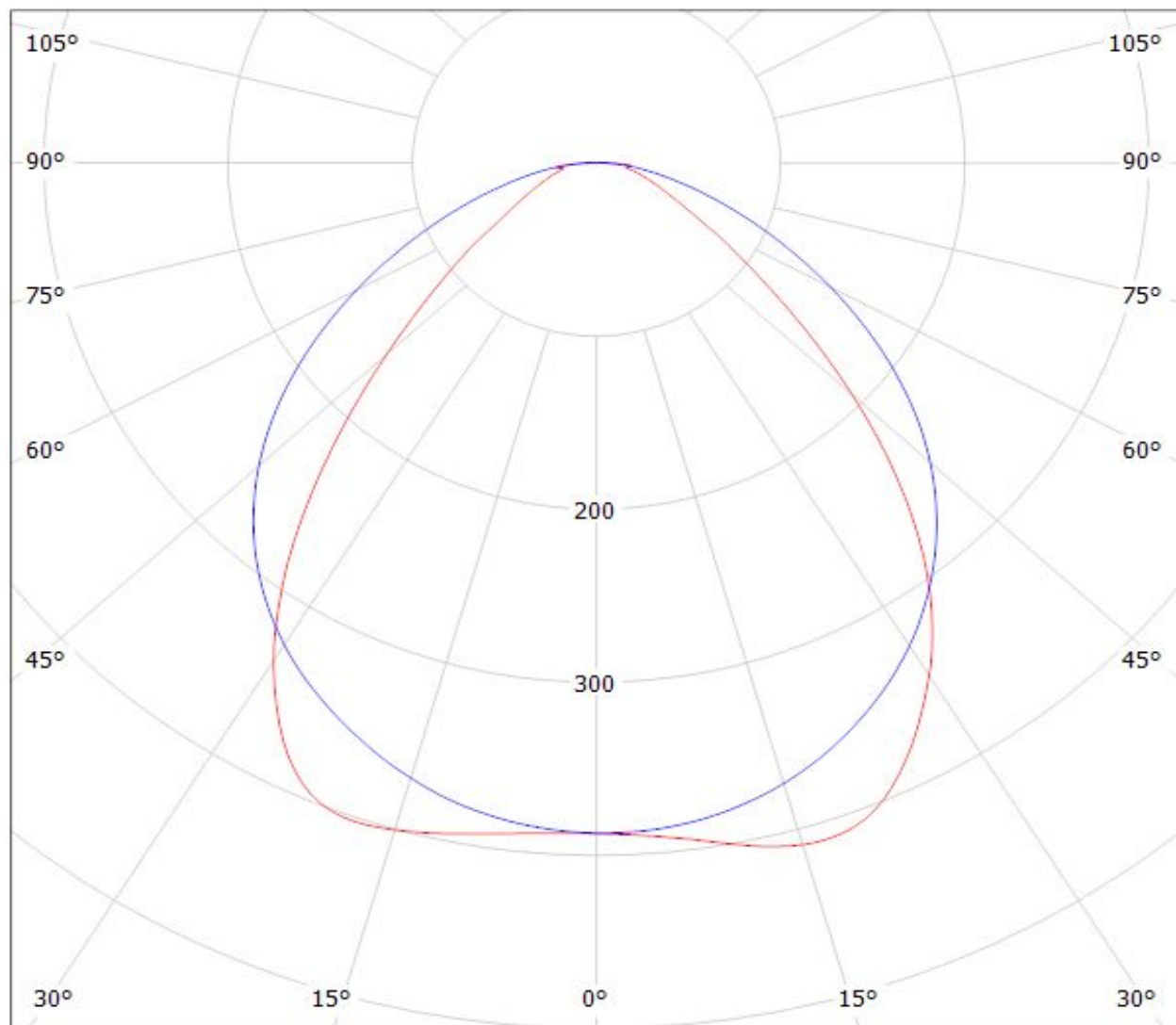

cd/klm

— C0 - C180

— C90 - C270

$\eta = 95\%$

Luminaire: LEDiL Oy F14304\_FLORENCE-1R-Z90\_(LM302A)

Lamps: 1 x Samsung\_LM302A\_865.46lm@100mA\_P=6.64694W\_I=0.1001A

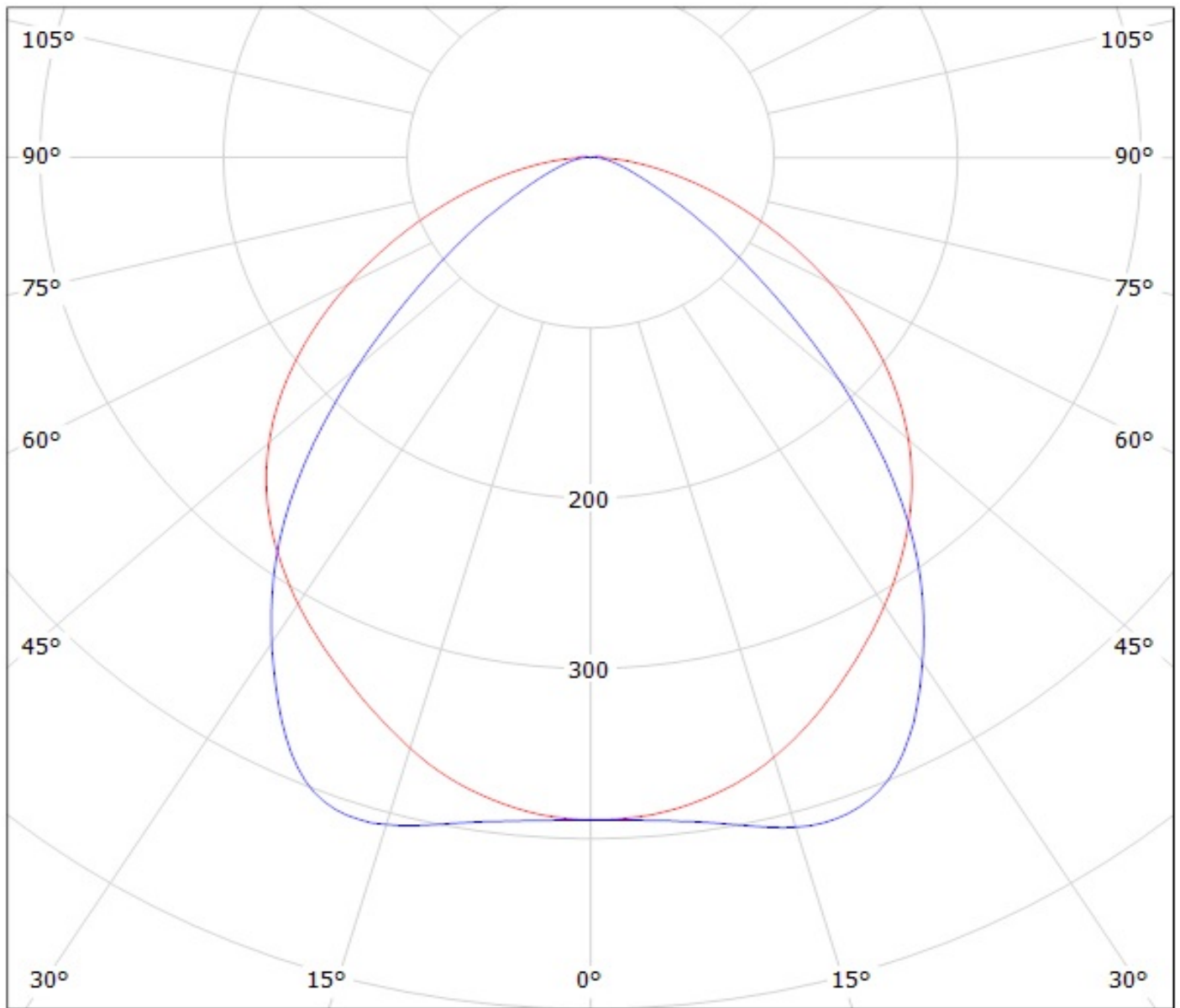

cd/klm

— C0 - C180

— C90 - C270

$\eta = 93\%$



# Ledil F14304\_FLORENCE-1R-Z90\_(LM561B) / LDC (Polar)

Luminaire: Ledil F14304\_FLORENCE-1R-Z90\_(LM561B)

Lamps: 1 x Samsung\_LM561B\_x22\_348.84lm@65mA\_P=1.97W\_I=65mA

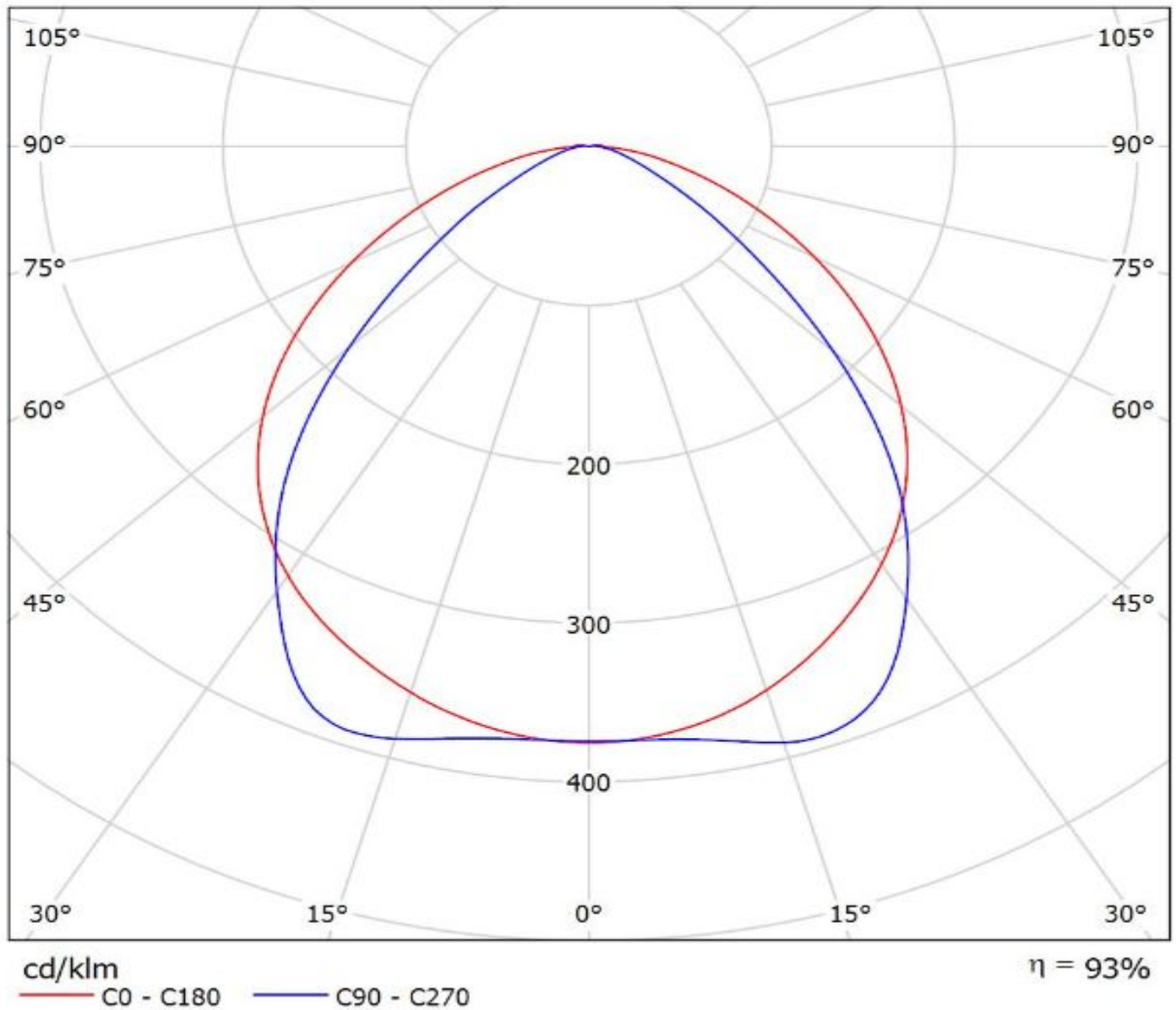

Luminaire: Ledil F14304\_FLORENCE-1R-Z90\_(LM301A)

Lamps: 1 x Samsung\_LM301A\_x11\_(SPMWHT328FD5WAT0S0)\_1087.4lm@250mA\_P=8.1922W\_I=0.25A

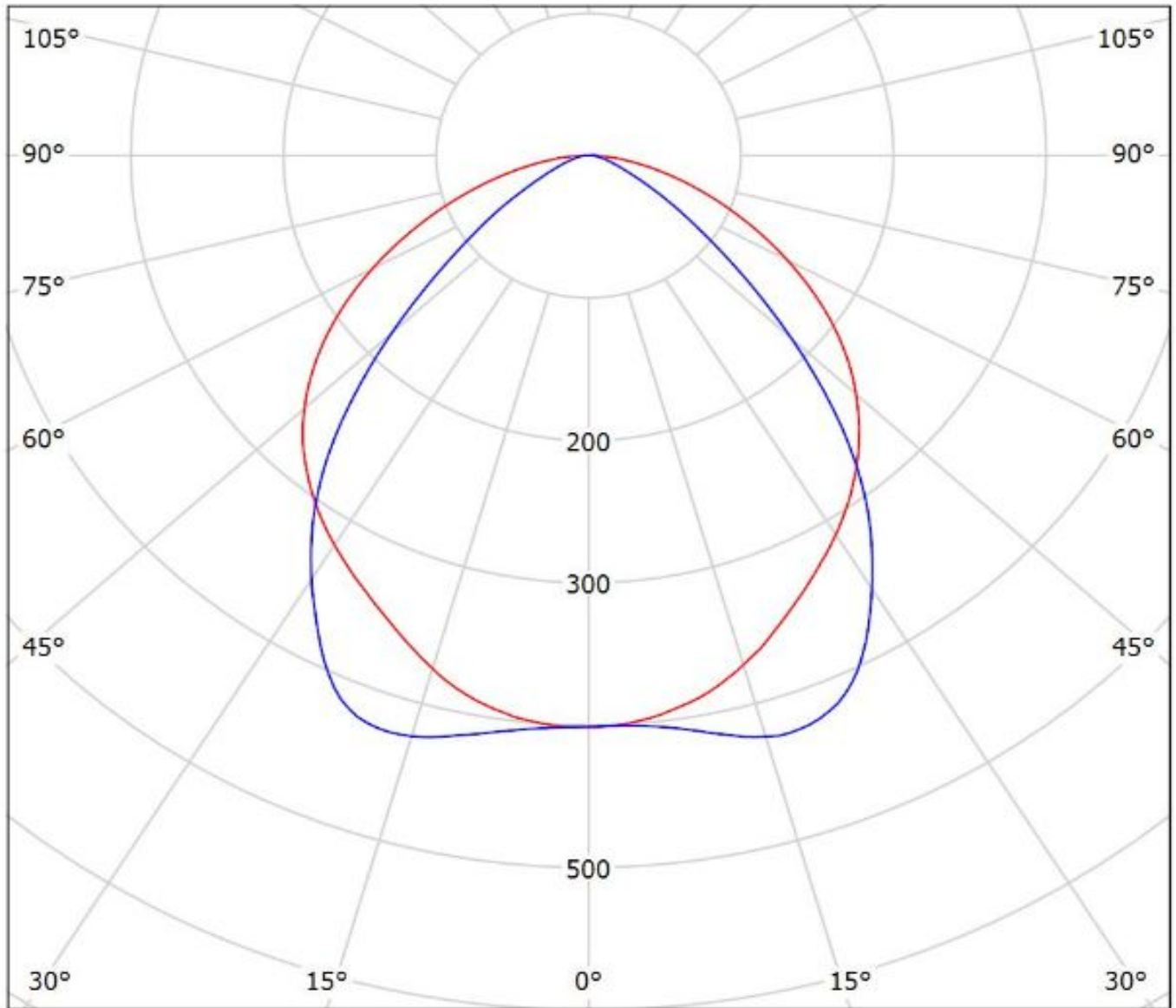

cd/klm

— C0 - C180 — C90 - C270

$\eta = 94\%$

Luminaire: Ledil F14304\_FLORENCE-1R-Z90\_(LT-S282N)

Lamps: 1 x Samsung SI-B8T071280LD\_LM5618+\_1401.55lm@250mA\_P=9.185W\_I=0.25A

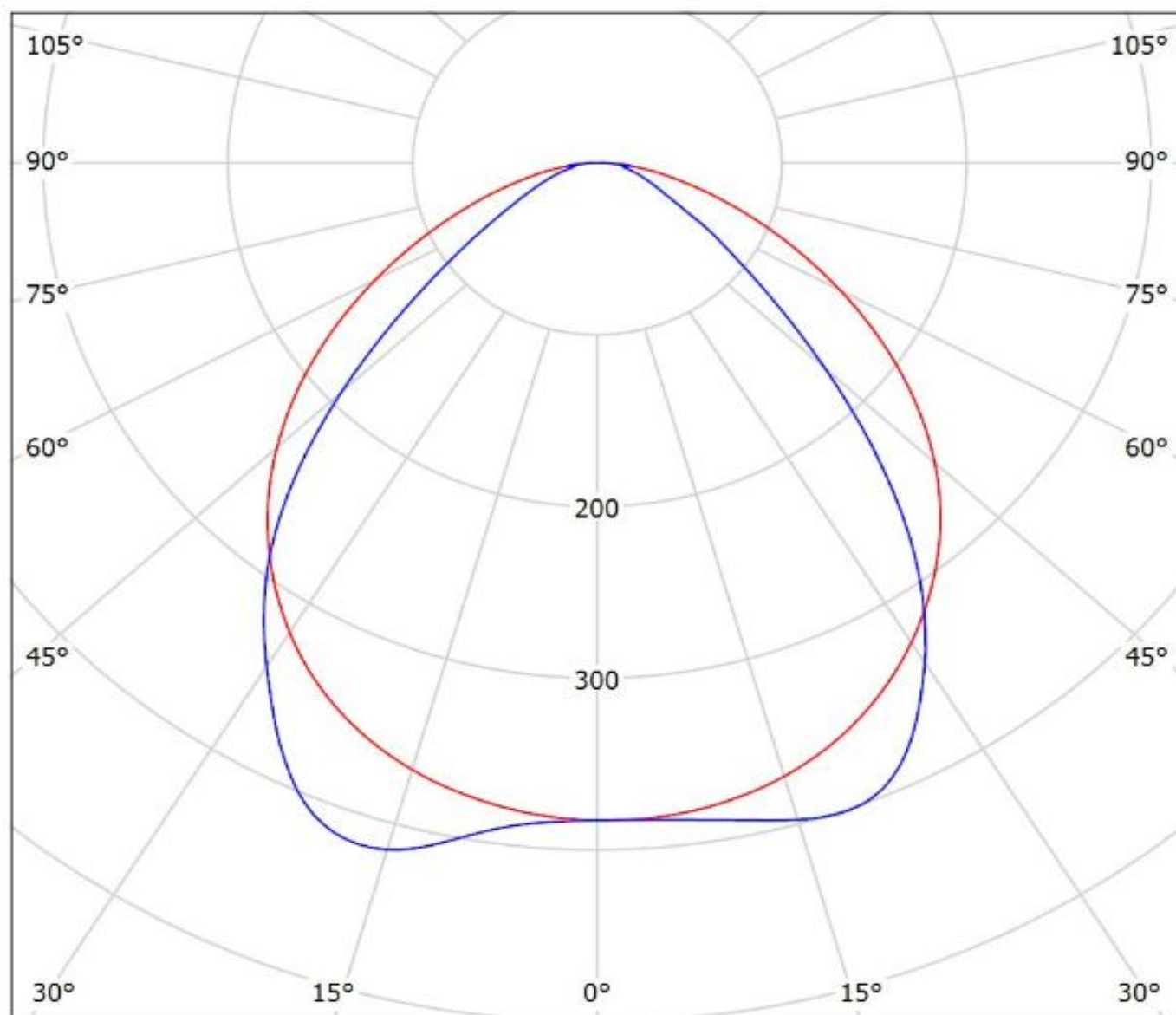

cd/klm

— C0 - C180 — C90 - C270

$\eta = 94\%$

Luminaire: LEDiL Oy F14304\_FLORENCE-1R-Z90\_(LM561C)

Lamps: 1 x Samsung\_LM561C\_688.201lm@130mA\_P=3.9390W\_I=0.130A

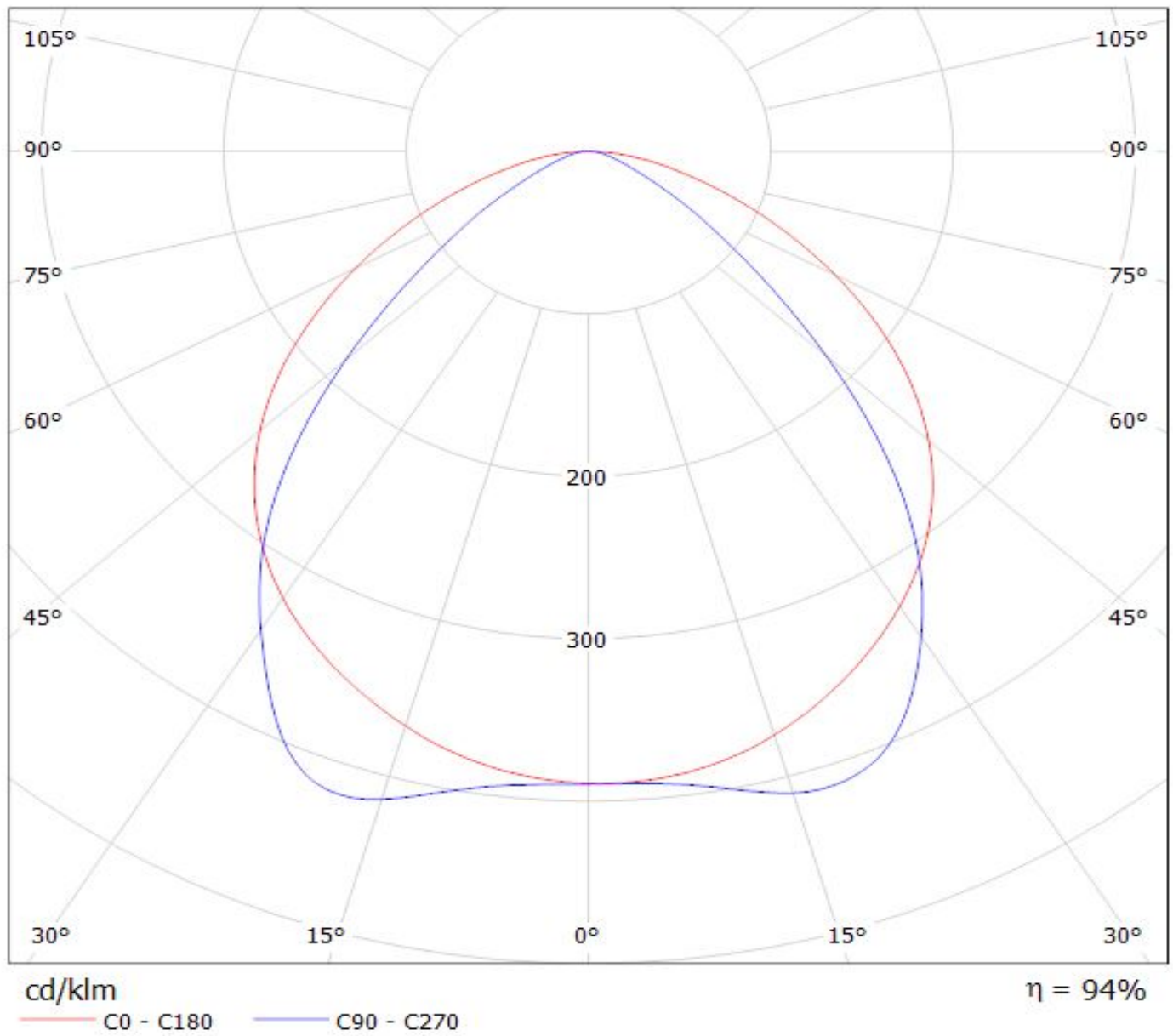

Luminaire: LEDiL Oy F14304\_FLORENCE-1R-Z90\_(LM281B)

Lamps: 1 x Samsung\_LM281B\_1309.14lm@300mA\_P=10.244W\_η=0.300A

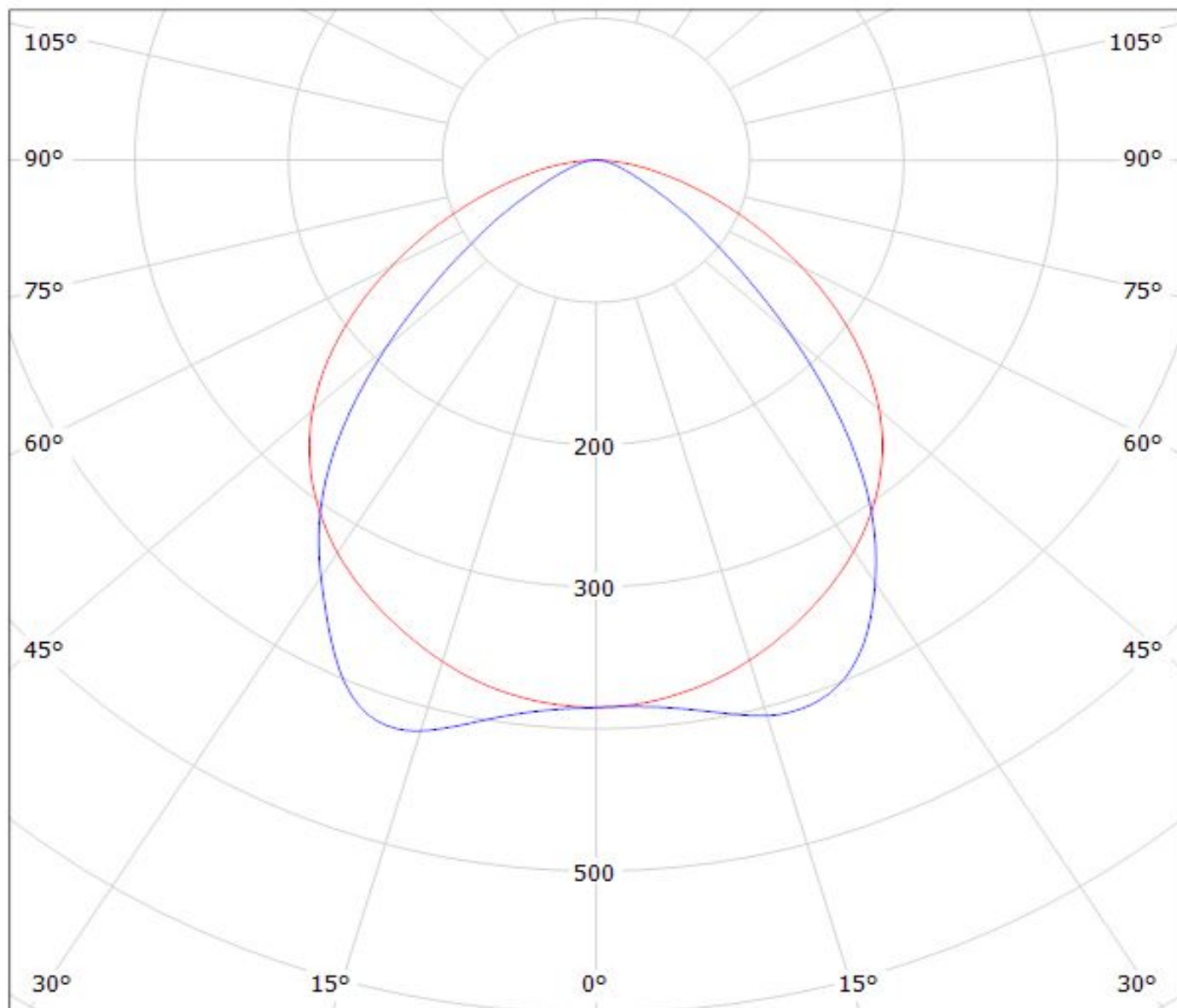

cd/klm

— C0 - C180 — C90 - C270

$\eta = 94\%$

# Ledil F14304\_FLORENCE-1R-Z90\_(Seoul\_3030) / LDC (Polar)

Luminaire: Ledil F14304\_FLORENCE-1R-Z90\_(Seoul\_3030)

Lamps: 1 x Seoul\_3030\_x11\_(STW8C2SA)\_785.296lm@100mA\_P=6.5W\_I=0.1A

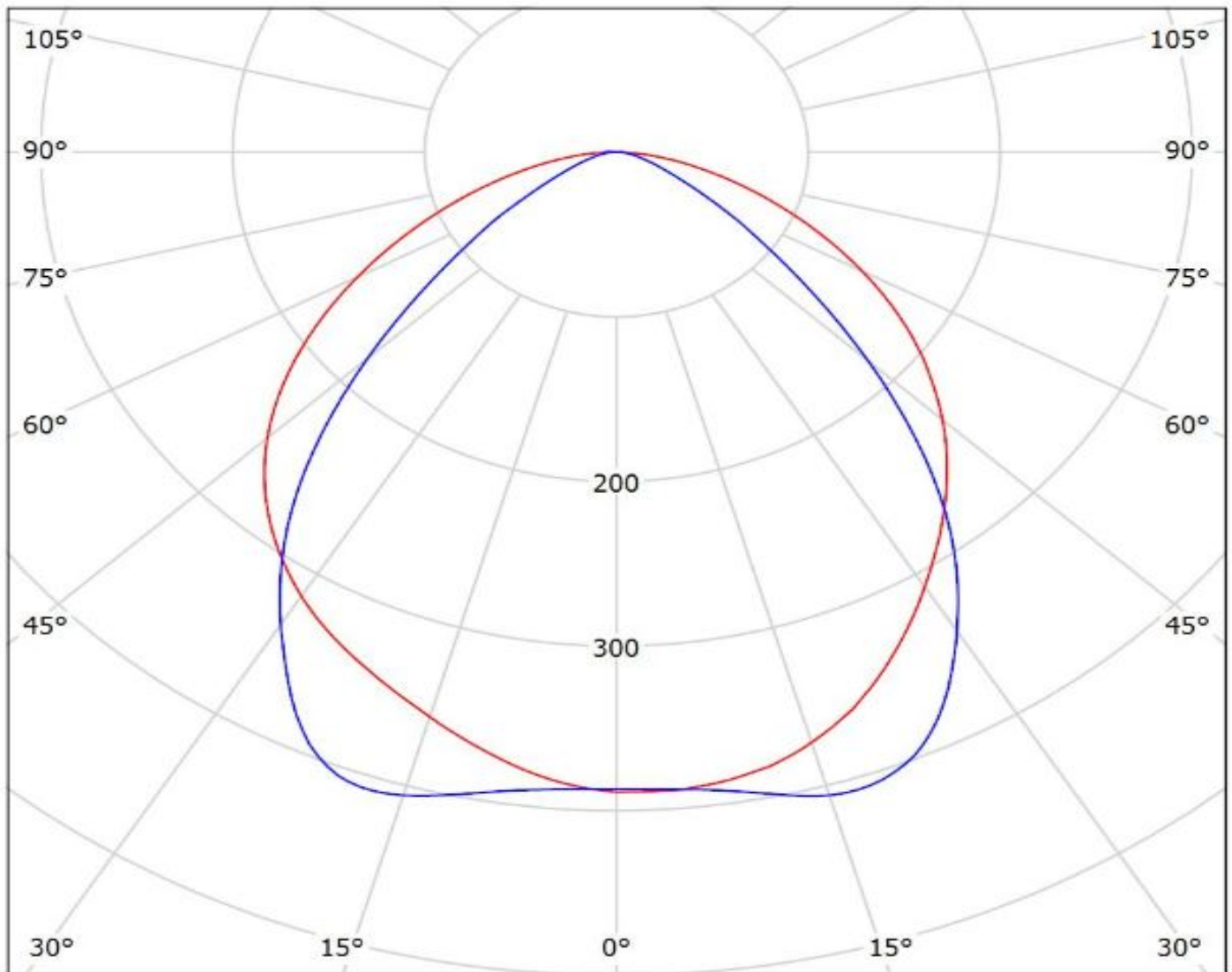

Luminaire: Ledil F14304\_FLORENCE-1R-Z90\_(SunLike\_3030)

Lamps: 1 x SEOUL\_SunLike\_3030\_(STW9C2PB-S)\_2\_240.649lm@0.65mA\_P=2.30531W\_U=35.538V

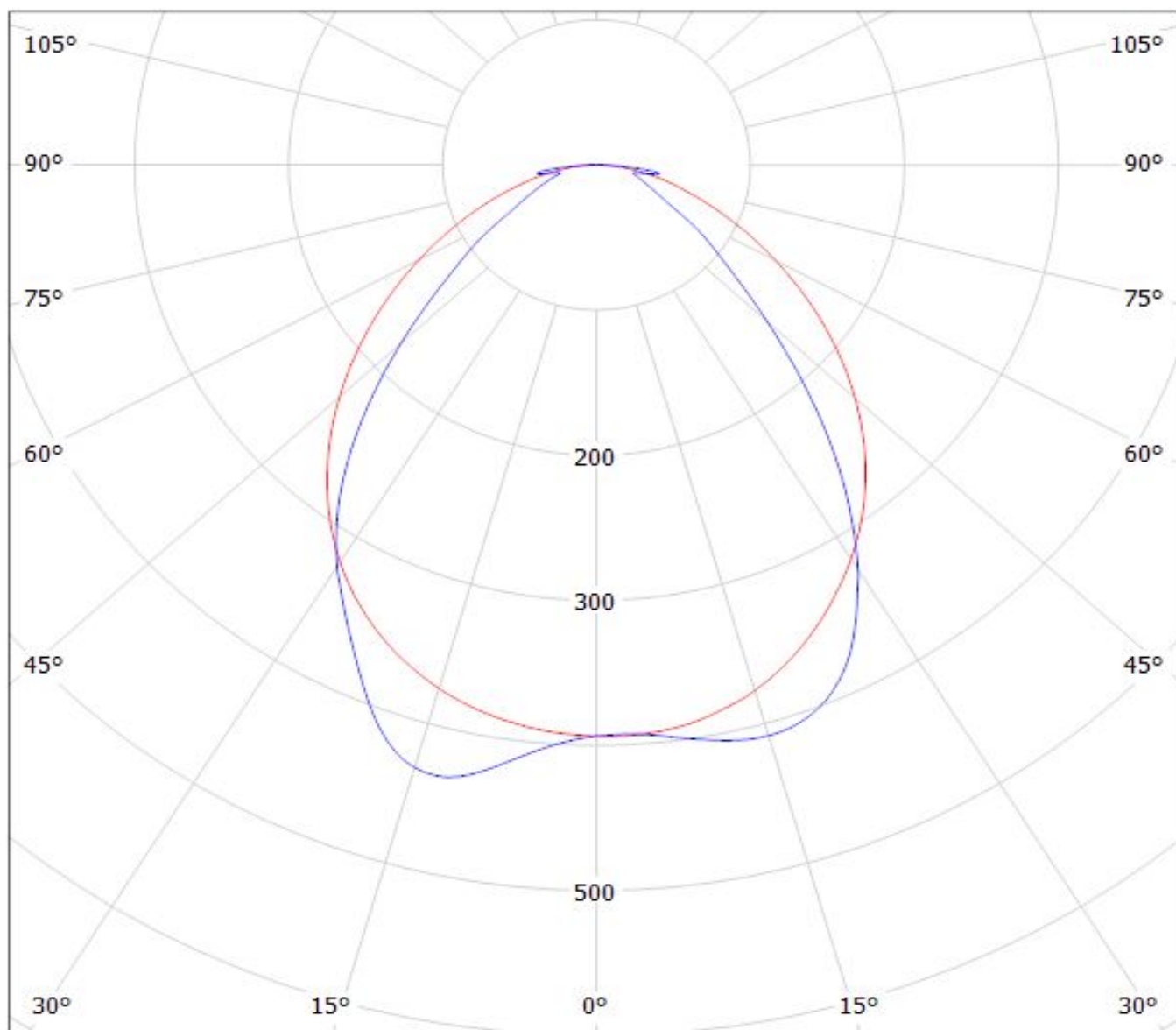

cd/klm

— C0 - C180 — C90 - C270

$\eta = 94\%$

Luminaire: Ledil F14304\_FLORENCE-1R-Z90\_(CALGD0414-M8W1)

Lamps: 1 x Citizen\_CALGD0414-M8W1\_556.672lm@350mA\_P=4.0291W\_I=0.3499A

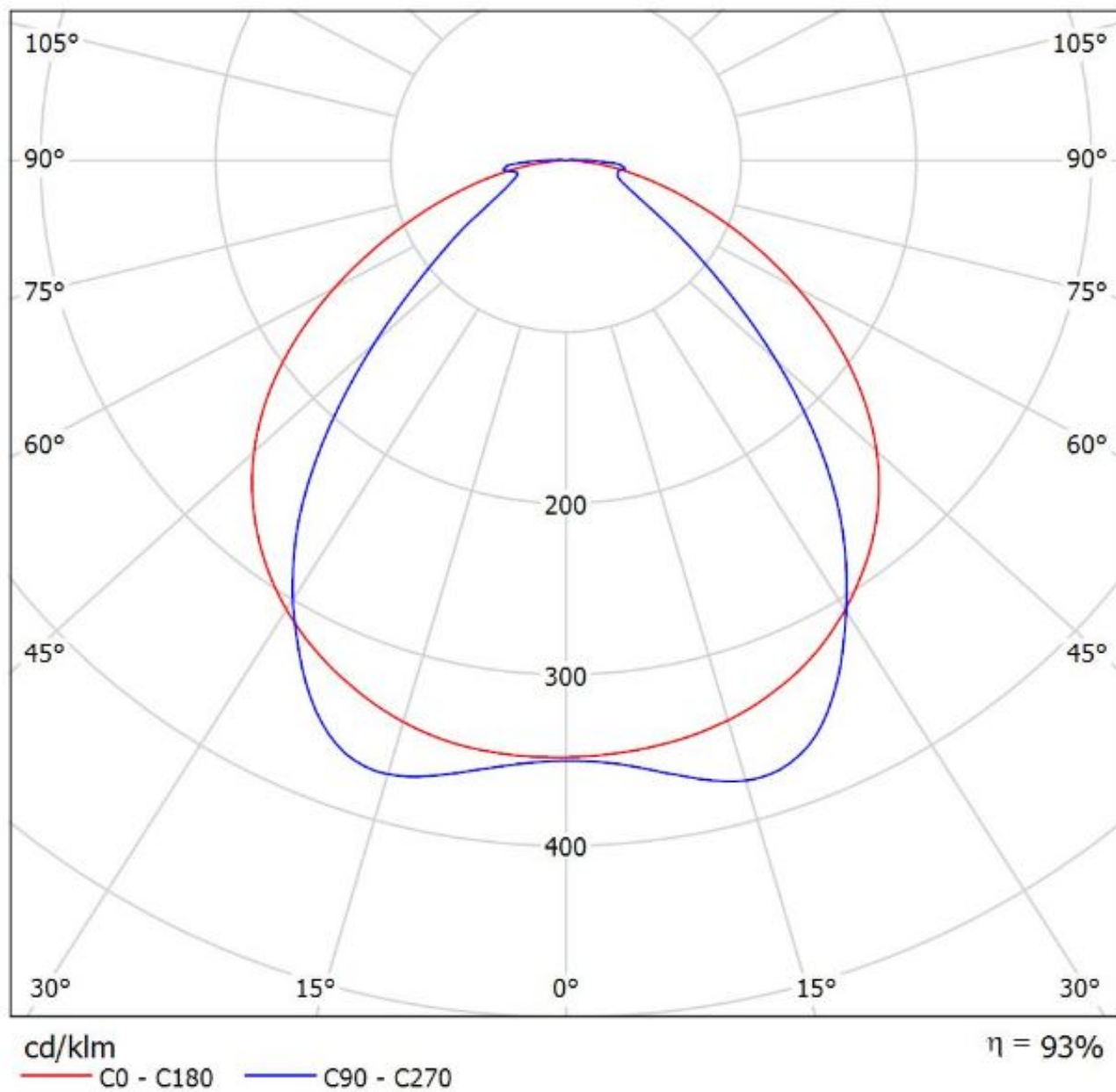



Luminaire: Ledil F14304\_FLORENCE-1R-Z90\_(CALGD0814-M17W1)

Lamps: 1 x Citizen\_(CALGD0814-M17W1)\_1098.26lm@350mA\_P=7.96302W\_I=0.3499A

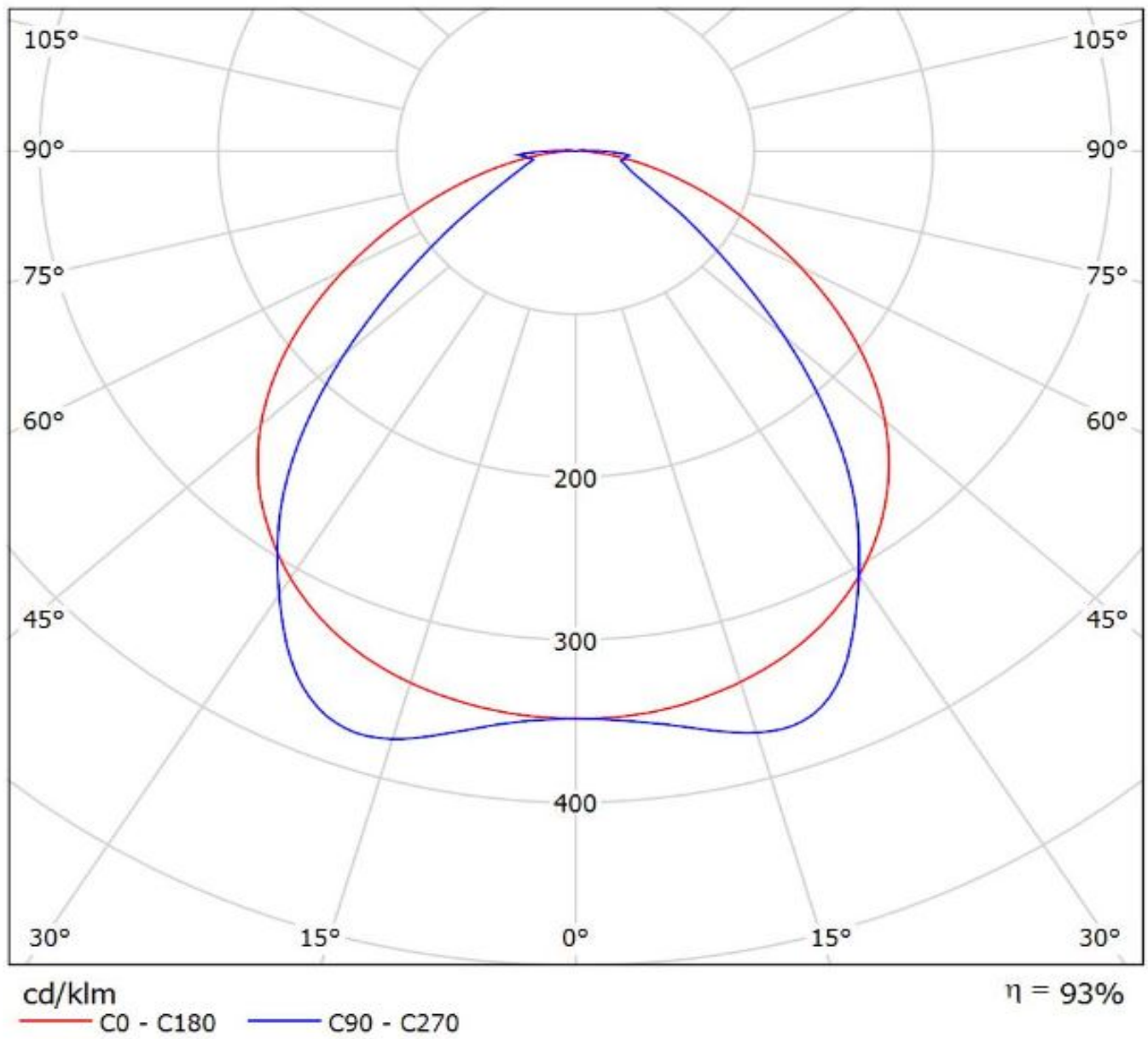

**NOTE: The typical divergence will be changed by different color, chip size and chip position tolerance. The typical total divergence is the full angle measured where the luminous intensity is half of the peak value.**