

Aluminum Electrolytic, 105C, ELG, 680 uF, 20%, 250 V, -25/+105C

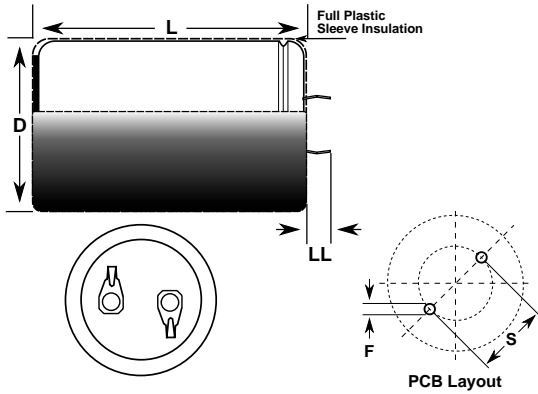

Dimensions

D	25mm +/-1mm
L	50mm +/-2mm
S	10mm +/-0.5mm
LL	5.8mm +/-1mm
F	2mm +/-0.1mm

Packaging Specifications

Packaging:	Bulk
-------------------	------

General Information

Dielectric:	Aluminum Electrolytic
Series:	ELG
Description:	Snap-In, Aluminum Electrolytic
RoHS:	Yes
Lead:	2 Pin

Specifications

Capacitance:	680 uF
Capacitance Tolerance:	20%
Voltage DC:	250 VDC, 300 VDC (Surge)
Temperature Range:	-25/+105C
Rated Temperature:	105C
Life:	2000 Hrs
Dissipation Factor:	15% 120Hz 20C
Resistance:	110 mOhms (20kHz)
Current:	1950 mAmps (120Hz)
Leakage Current:	3000 uAmps (5min 20C)