

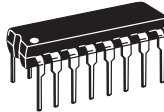

**Legacy Device:** *Motorola MC13055*

The ML13055 is intended for RF data link systems using carrier frequencies up to 40 MHz and FSK (frequency shift keying) data rates up to 2.0 M Baud (1.0 MHz). This design is similar to the ML3356, except that it does not include the oscillator/mixer. The IF bandwidth has been increased and the detector output has been revised to a balanced configuration. The received signal strength metering circuit has been retained, as has the versatile data slicer/comparator.

- Input Sensitivity 20  $\mu$ V @ 40 MHz
- Signal Strength Indicator Linear Over 3 Decades
- Easy Application, Few Peripheral Components
- Operating Temperature Range  $T_A = -40^\circ$  to  $+85^\circ\text{C}$



**P-DIP 16 = EP**  
Plastic DIP



**SO 16 = -5P**

PACKAGE	MOTOROLA	LANSDALE
P-DIP 16	MC13055P	ML13055EP
SO 16	MC13055D	ML13055-5P

**Note:** Lansdale lead free (**Pb**) product, as it becomes available, will be identified by a part number prefix change from **ML** to **MLE**.

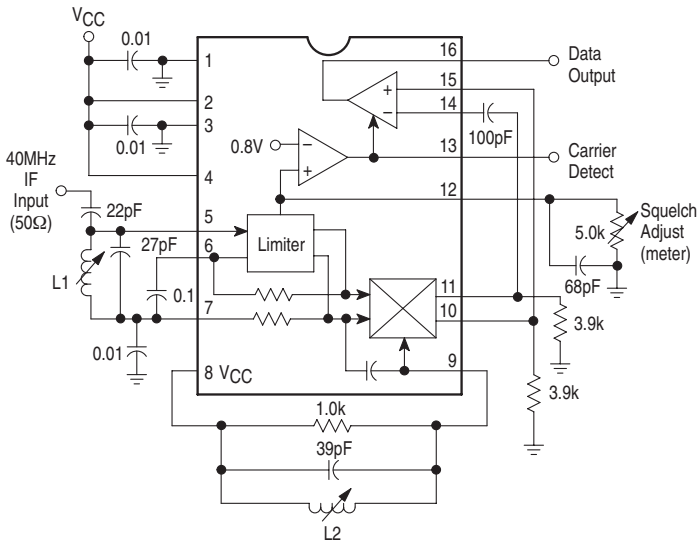

**Figure 1. Block Diagram and Application Circuit**

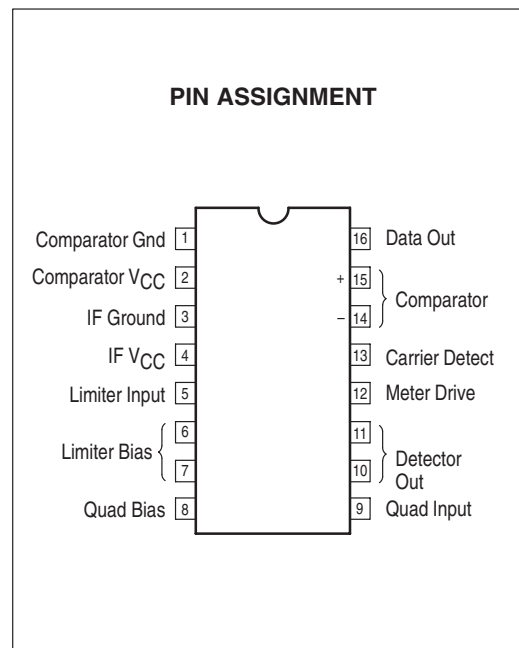

**MAXIMUM RATINGS**

Rating	Symbol	Value	Unit
Power Supply Voltage	$V_{CC(max)}$	15	Vdc
Operating Supply Voltage Range	V2, V4	3.0 to 12	Vdc
Junction Temperature	$T_J$	150	$^{\circ}C$
Operating Ambient Temperature Range	$T_A$	-40 to +85	$^{\circ}C$
Storage Temperature Range	$T_{stg}$	-65 to +150	$^{\circ}C$
Power Dissipation, Package Rating	$P_D$	1.25	W

**ELECTRICAL CHARACTERISTICS** ( $V_{CC} = 5.0$  Vdc,  $f_o = 40$  MHz,  $f_{mod} = 1.0$  MHz,  $\Delta f = \pm 1.0$  MHz,  $T_A = 25^{\circ}C$ , test circuit of Figure 2.)

Characteristic	Conditions	Min	Typ	Max	Unit
Total Drain Current	I2 + I4		20	25	mA
Data Comparator Pull-Down Current	I16		10		mA
Meter Drive Slope versus Input	I12	4.5	7.0	9.0	$\mu A/dB$
Carrier Detect Pull-Down Current	I13		1.3		mA
Carrier Detect Pull-Up Current	I13		500		$\mu A$
Carrier Detect Threshold Voltage	V12	690	800	1010	mV
DC Output Current	I10, I11		430		$\mu A$
Recovered Signal	V10 - V11		350		mVrms
Sensitivity for 20 dB S+N/N, BW = 5.0 MHz	VIN		20		$\mu V_{rms}$
S+N/N at $V_{in} = 50 \mu V$	V10 - V11		30		dB
Input Impedance @ 40 MHz	$R_{in}$	Pin 5, Ground	4.2		k $\Omega$
	$C_{in}$		4.5		pF
Quadrature Coil Loading	$R_{in}$	Pin 9 to 8	7.6		k $\Omega$
	$C_{in}$		5.2		pF

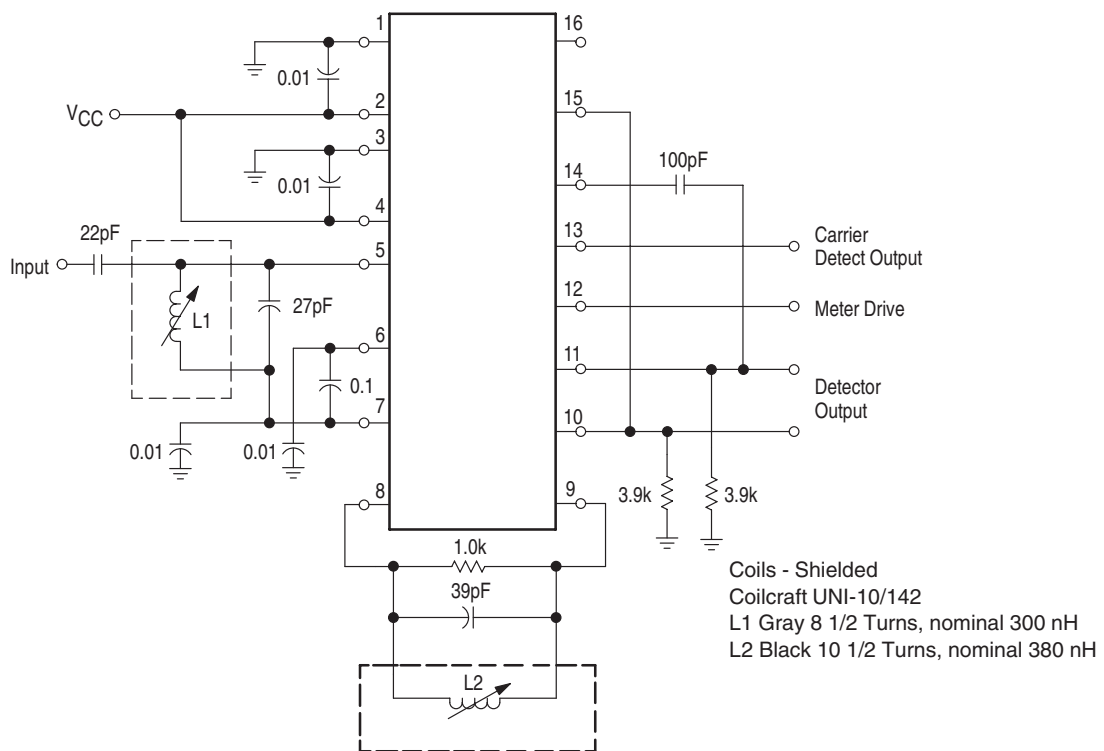

Figure 2. Test Circuit

Figure 3. Overall Gain, Noise, AM Rejection

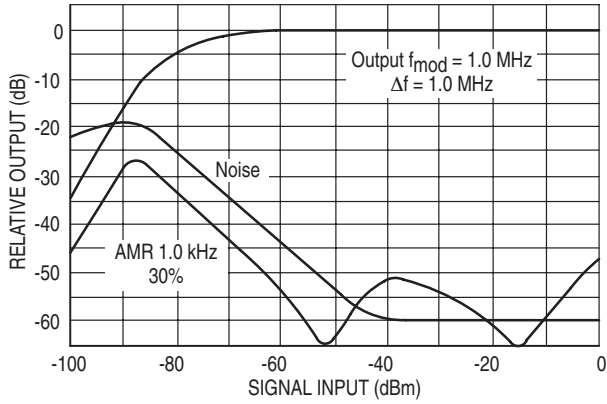

Figure 4. Meter Current versus Signal

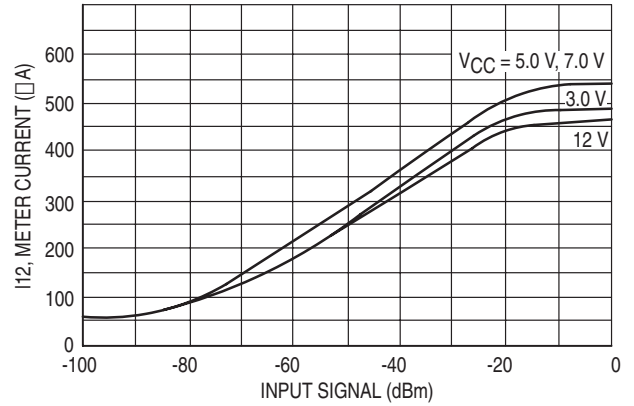

Figure 5. Untuned Input: Limiting Sensitivity versus Frequency

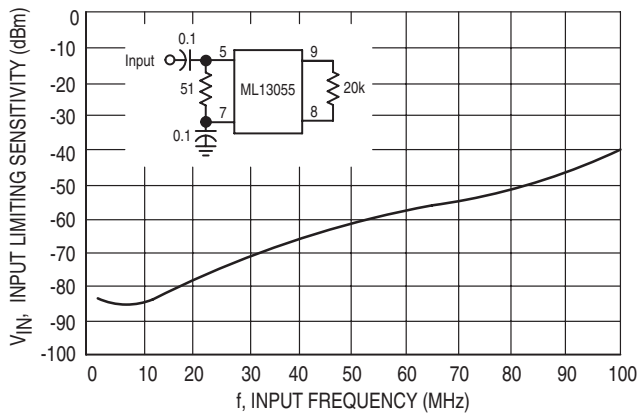

Figure 6. Untuned Input: Meter Current versus Frequency

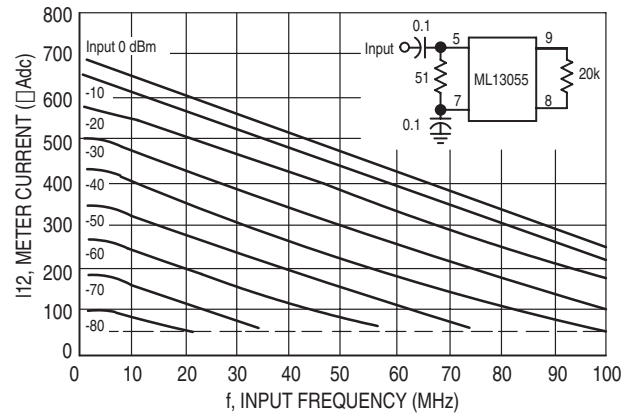

Figure 7. Limiting Sensitivity and Detuning versus Supply Voltage

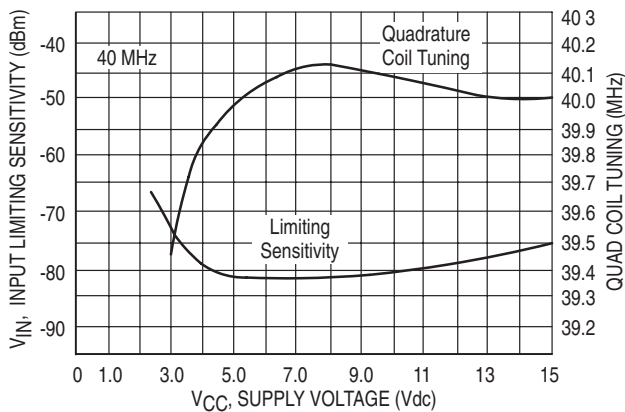

Figure 8. Detector Current and Power Supply Current versus Supply Voltage

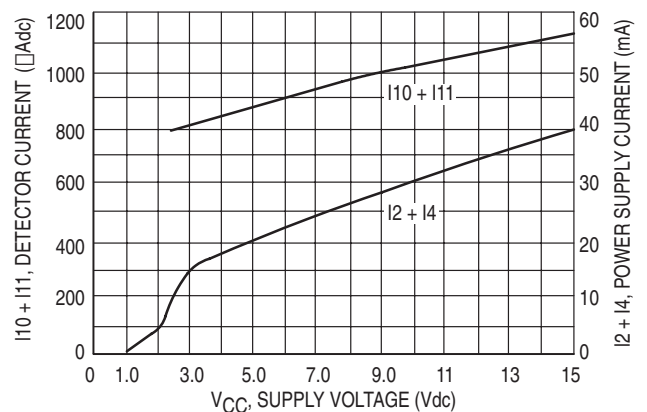

Figure 9. Recovered Audio versus Temperature

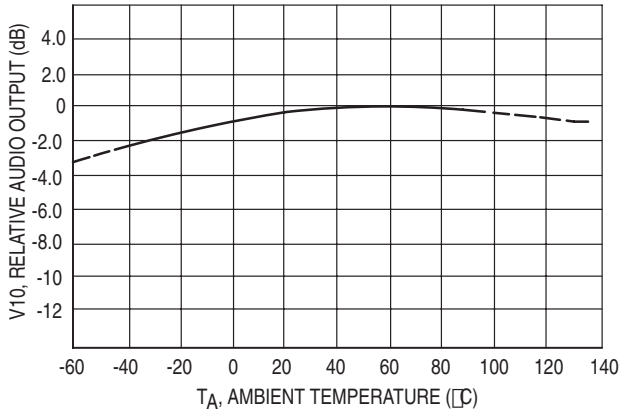

Figure 10. Carrier Detect Threshold versus Temperature

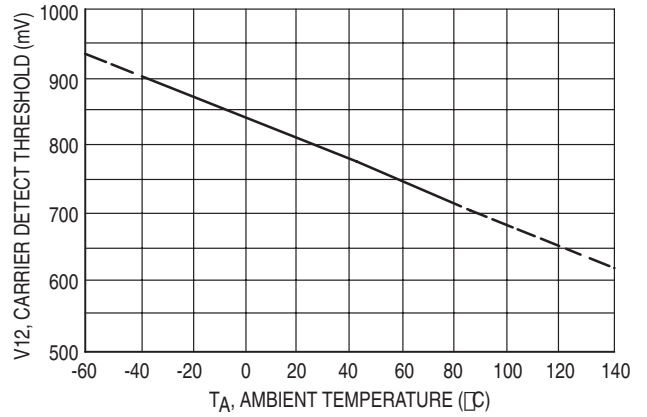

Figure 11. Meter Current versus Temperature

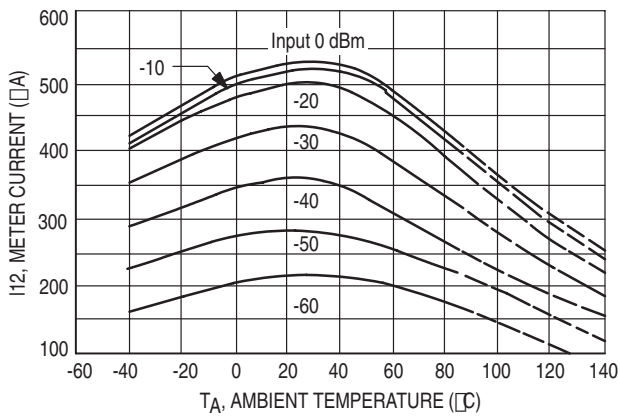

Figure 12. Input Limiting versus Temperature

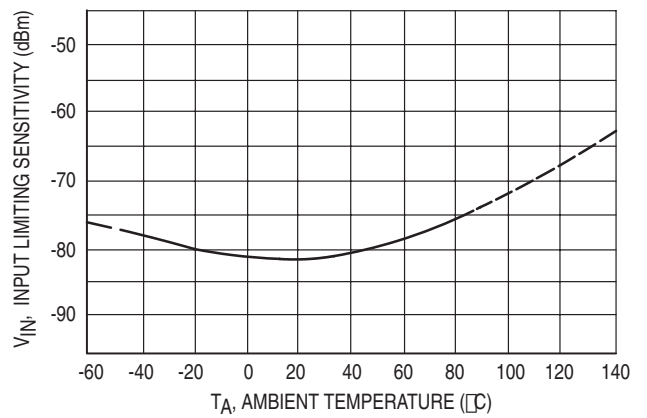
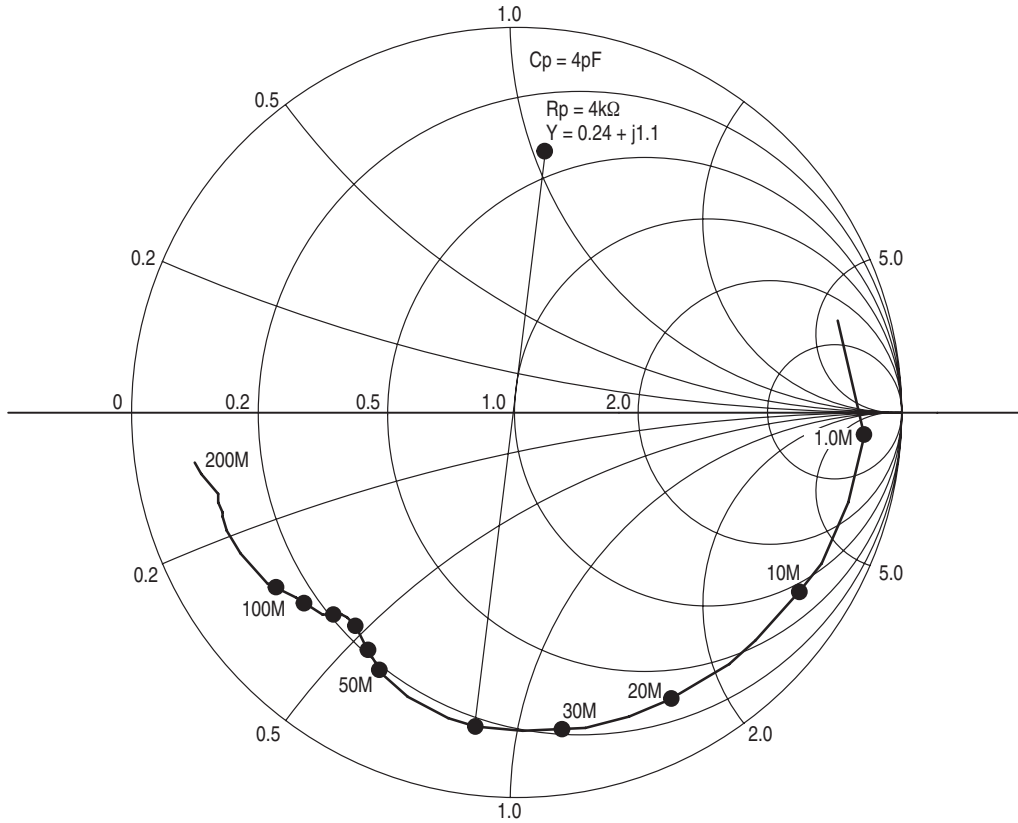
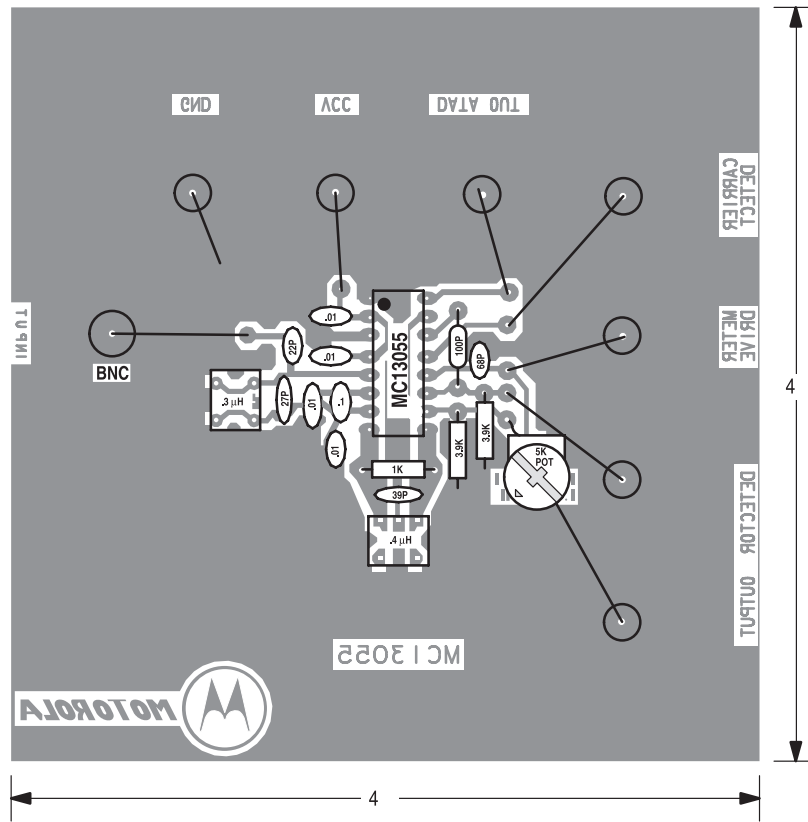

Figure 13. Input Impedance, Pin 5



Legacy Information

Figure 14. Test Fixture  
(Component Layout)



(Circuit Side View)

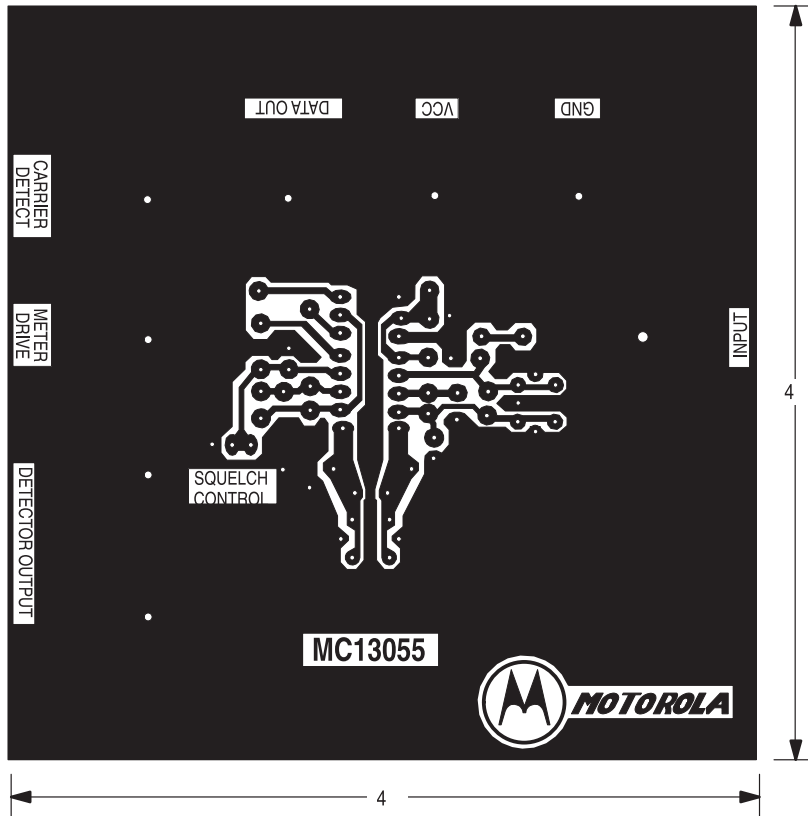
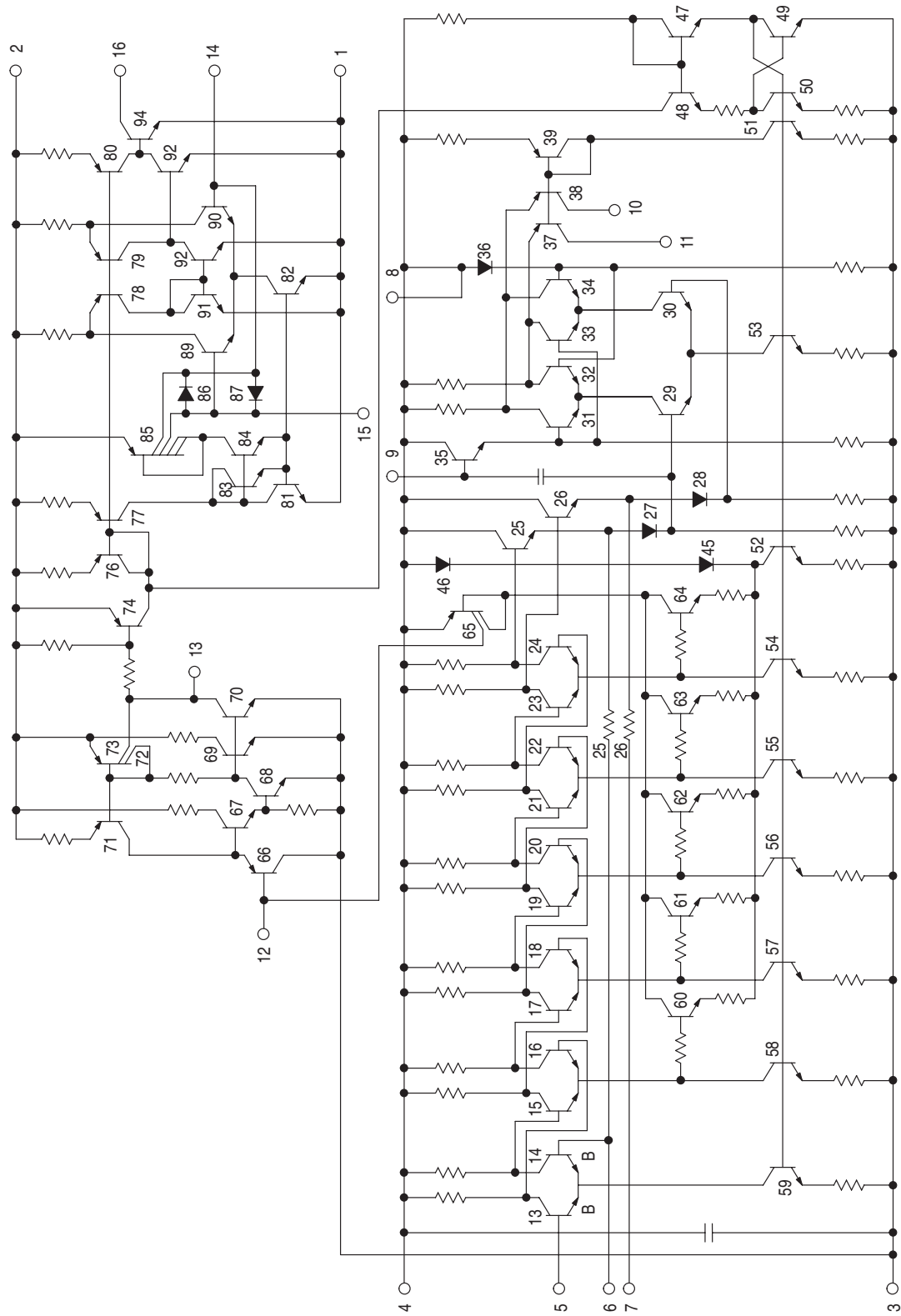

Figure 15. Internal Schematic



## GENERAL DESCRIPTION

The ML13055 is an extended frequency range FM IF, quadrature detector, signal strength detector and data shaper. It is intended primarily for FSK data systems. The design is very similar to ML3356 except that the oscillator/mixer has been removed, and the frequency capability of the IF has been raised about 2:1. The detector output configuration has been changed to a balanced, open-collector type to permit symmetrical drive of the data shaper (comparator). Meter drive and squelch features have been retained.

The limiting IF is a high frequency type, capable of being operated up to 100 MHz. It is expected to be used at 40 MHz in most cases. The quadrature detector is internally coupled to the IF, and a 2.0 pF quadrature capacitor is internally provided. The 20 dB quieting sensitivity is approximately 20  $\mu$ V, tuned input, and the IF can accept signals up to 220 mVrms without distortion or change of detector quiescent DC level.

The IF is unusual in that each of the last 5 stages of the 6 stage limiter contains a signal strength sensitive, current sinking device. These are parallel connected and buffered to produce a signal strength meter drive which is fairly linear for IF input signals of 20  $\mu$ V to 20 mVrms (see Figure 4).

A simple squelch arrangement is provided whereby the meter current flowing through the meter load resistance flips a comparator at about 0.8 Vdc above ground. The signal strength at which this occurs can be adjusted by changing the meter load resistor. The comparator (+) input and output are available to permit control of hysteresis. Good positive action can be obtained for IF input signals of above 20  $\mu$ Vrms. A resistor (R) from Pin 13 to Pin 12 will provide  $V_{CC}/R$  of feedback current. This current can be correlated to an amount of signal strength hysteresis by using Figure 4.

The squelch is internally connected to the data shaper. Squelch causes the data shaper to produce a high ( $V_{CC}$ ) output.

The data shaper is a complete “floating” comparator, with diodes across its inputs. The outputs of the quadrature detector can be fed directly to either or preferably both inputs of the comparator to produce a squared output swinging from  $V_{CC}$  to ground in inverted or noninverted form.



### OUTLINE DIMENSION

**P-DIP 16**  
(ML13055EP)  
PLASTIC PACKAGE  
CASE 648-08  
ISSUE R

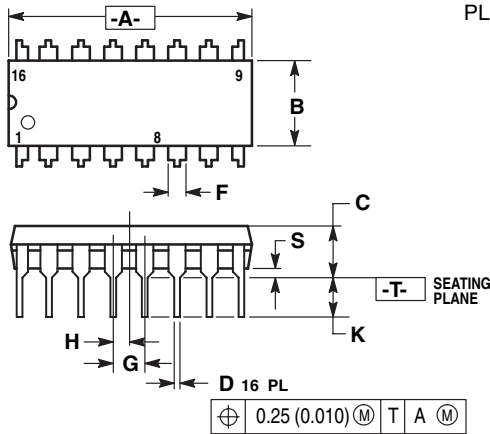

- NOTES:
1. DIMENSIONING AND TOLERANCING PER ANSI Y14.5M, 1982.
  2. CONTROLLING DIMENSION: INCH.
  3. DIMENSION L TO CENTER OF LEADS WHEN FORMED PARALLEL.
  4. DIMENSION B DOES NOT INCLUDE MOLD FLASH.
  5. ROUNDED CORNERS OPTIONAL.

DIM	INCHES		MILLIMETERS	
	MIN	MAX	MIN	MAX
A	0.740	0.770	18.80	19.55
B	0.250	0.270	6.35	6.85
C	0.145	0.175	3.69	4.44
D	0.015	0.021	0.39	0.53
F	0.040	0.70	1.02	1.77
G	0.100 BSC		2.54 BSC	
H	0.050 BSC		1.27 BSC	
J	0.008	0.015	0.21	0.38
K	0.110	0.130	2.80	3.30
L	0.295	0.305	7.50	7.74
M	0°	10°	0°	10°
S	0.020	0.040	0.51	1.01

**SO 16**  
(ML13055-5P)  
PLASTIC PACKAGE  
CASE 751B-05  
(SO-16)  
ISSUE J

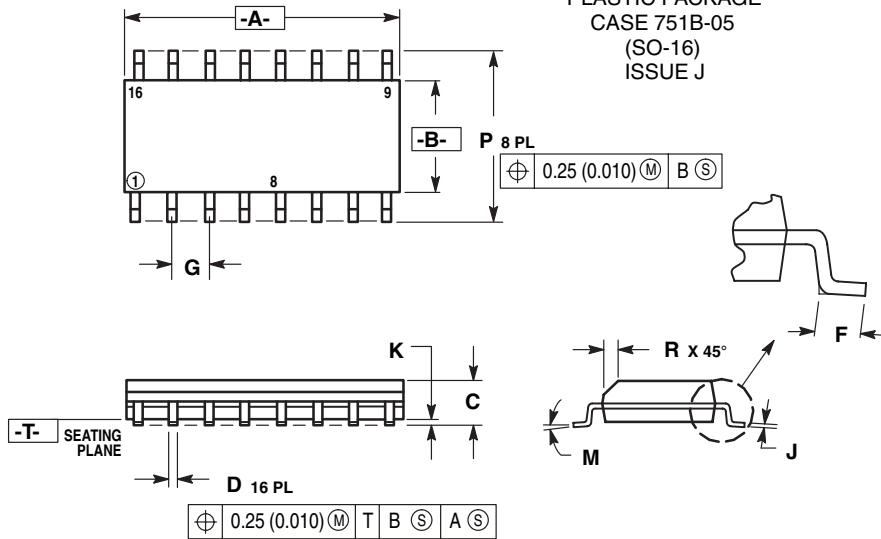

- NOTES:
1. DIMENSIONING AND TOLERANCING PER ANSI Y14.5M, 1982.
  2. CONTROLLING DIMENSION: MILLIMETER.
  3. DIMENSIONS A AND B DO NOT INCLUDE MOLD PROTRUSION.
  4. MAXIMUM MOLD PROTRUSION 0.15 (0.006) PER SIDE.
  5. DIMENSION D DOES NOT INCLUDE DAMBAR PROTRUSION. ALLOWABLE DAMBAR PROTRUSION SHALL BE 0.127 (0.005) TOTAL IN EXCESS OF THE D DIMENSION AT MAXIMUM MATERIAL CONDITION.

DIM	MILLIMETERS		INCHES	
	MIN	MAX	MIN	MAX
A	9.80	10.00	0.386	0.393
B	3.80	4.00	0.150	0.157
C	1.35	1.75	0.054	0.068
D	0.35	0.49	0.014	0.019
F	0.40	1.25	0.016	0.049
G	1.27 BSC		0.050 BSC	
J	0.19	0.25	0.008	0.009
K	0.10	0.25	0.004	0.009
M	0°	7°	0°	7°
P	5.80	6.20	0.229	0.244
R	0.25	0.50	0.010	0.019

Lansdale Semiconductor reserves the right to make changes without further notice to any products herein to improve reliability, function or design. Lansdale does not assume any liability arising out of the application or use of any product or circuit described herein; neither does it convey any license under its patent rights nor the rights of others. "Typical" parameters which may be provided in Lansdale data sheets and/or specifications can vary in different applications, and actual performance may vary over time. All operating parameters, including "Typicals" must be validated for each customer application by the customer's technical experts. Lansdale Semiconductor is a registered trademark of Lansdale Semiconductor, Inc.