

DirectFET® N-Channel Power MOSFET ②

Applications

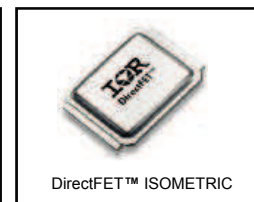
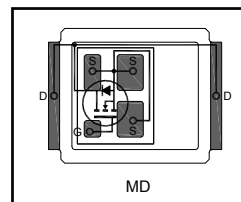
- ORing, eFuse, and high current load switch
- Load switch for battery application
- Inverter switches for DC motor application

Typical values (unless otherwise specified)

V _{DSS}	V _{GS}	V _{GS(th)}	R _{DS(on)}	R _{DS(on)}	R _{DS(on)}
20V max	±12V max	0.8V	0.50mΩ@10V	0.65mΩ@4.5V	1.1mΩ@2.5V

Features and Benefits

- Environmentally Friendly Product
- RoHs compliant containing no Lead, no Bromide and no Halogen
- Very Low R_{DS(on)}



Applicable DirectFET Outline and Substrate Outline (see p.7,8 for details) ①

SQ	SX	ST		MQ	MD	MT	MP	MC		
----	----	----	--	----	-----------	----	----	----	--	--

Description

The IRL6283MTRPbF combines the latest HEXFET® N-Channel Power MOSFET Silicon technology with the advanced DirectFET® packaging to achieve the lowest on-state resistance in a package that has the footprint of a SO-8 and only 0.6 mm profile. The DirectFET® package is compatible with existing layout geometries used in power applications, PCB assembly equipment and vapor phase, infra-red or convection soldering techniques, when application note AN-1035 is followed regarding the manufacturing methods and processes. The DirectFET package allows dual sided cooling to maximize thermal transfer in power systems, improving previous best thermal resistance by 80%.

Base part number	Package Type	Standard Pack		Orderable Part Number
		Form	Quantity	
IRL6283MTRPbF	DirectFET Medium Can	Tape and Reel	4800	IRL6283MTRPbF

Absolute Maximum Ratings

	Parameter	Max.	Units
V _{GS}	Gate-to-Source Voltage	±12	V
I _D @ T _A = 25°C	Continuous Drain Current, V _{GS} @ 4.5V ③	38	A
I _D @ T _A = 70°C	Continuous Drain Current, V _{GS} @ 4.5V ③	30	
I _D @ T _C = 25°C	Continuous Drain Current, V _{GS} @ 4.5V ④	211	
I _{DM}	Pulsed Drain Current ⑤	305	
E _{AS}	Single Pulse Avalanche Energy ⑥	406	mJ
I _{AR}	Avalanche Current ⑤	30	A

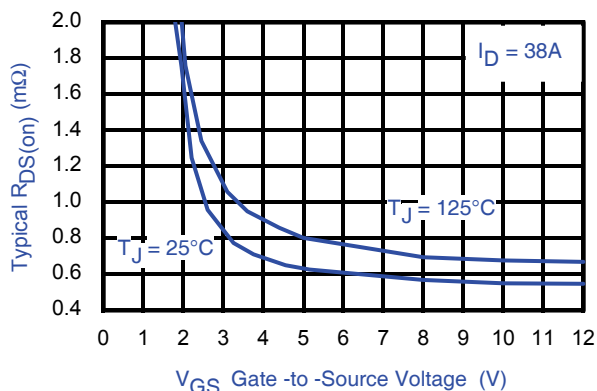


Fig 1. Typical On-Resistance vs. Gate Voltage

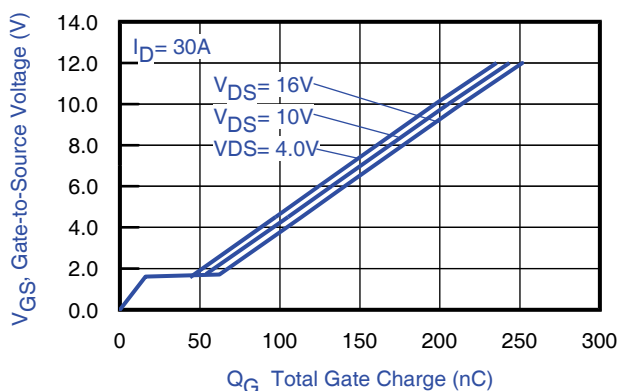


Fig 2. Typical Total Gate Charge vs. Gate-to-Source Voltage

Notes:

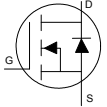
- ① Click on this section to link to the appropriate technical paper.
- ② Click on this section to link to the DirectFET Website.
- ③ Surface mounted on 1 in. square Cu board, steady state.

- ④ T_c measured with thermocouple mounted to top (Drain) of part.
- ⑤ Repetitive rating; pulse width limited by max. junction temperature.
- ⑥ Starting T_J = 25°C, L = 0.88mH, R_G = 50Ω, I_{AS} = 30A.

Static @ T_J = 25°C (unless otherwise specified)

	Parameter	Min.	Typ.	Max.	Units	Conditions
BV _{DSS}	Drain-to-Source Breakdown Voltage	20	—	—	V	V _{GS} = 0V, I _D = 250μA
ΔBV _{DSS} /ΔT _J	Breakdown Voltage Temp. Coefficient	—	4.8	—	mV/°C	Reference to 25°C, I _D = 1.0mA
R _{DS(on)}	Static Drain-to-Source On-Resistance	—	0.50	0.75	mΩ	V _{GS} = 10V, I _D = 50A ⑦
		—	0.65	0.87		V _{GS} = 4.5V, I _D = 50A ⑦
		—	1.1	1.5		V _{GS} = 2.5V, I _D = 50A ⑦
V _{GS(th)}	Gate Threshold Voltage	0.5	0.8	1.1	V	V _{DS} = V _{GS} , I _D = 100μA
ΔV _{GS(th)}	Gate Threshold Voltage Coefficient	—	-3.9	—	mV/°C	
I _{DSS}	Drain-to-Source Leakage Current	—	—	1.0	μA	V _{DS} = 16V, V _{GS} = 0V
		—	—	150		V _{DS} = 16V, V _{GS} = 0V, T _J = 125°C
I _{GSS}	Gate-to-Source Forward Leakage	—	—	100	nA	V _{GS} = 12V
	Gate-to-Source Reverse Leakage	—	—	-100		V _{GS} = -12V
g _{fs}	Forward Transconductance	320	—	—	S	V _{DS} = 10V, I _D = 30A
Q _g	Total Gate Charge	—	105	158	nC	V _{DS} = 10V V _{GS} = 4.5V I _D = 30A
Q _{gs1}	Pre-V _{th} Gate-to-Source Charge	—	9.7	—		
Q _{gs2}	Post-V _{th} Gate-to-Source Charge	—	8.9	—		
Q _{gd}	Gate-to-Drain Charge	—	35	—		
Q _{odr}	Gate Charge Overdrive	—	51	—		
Q _{sw}	Switch Charge (Q _{gs2} + Q _{gd})	—	44	—		
Q _{oss}	Output Charge	—	50	—	nC	V _{DS} = 16V, V _{GS} = 0V
R _G	Gate Resistance	—	1.1	—	Ω	
t _{d(on)}	Turn-On Delay Time	—	23	—	ns	V _{DD} = 20V, V _{GS} = 4.5V ⑦ I _D = 30A R _G = 1.8Ω
t _r	Rise Time	—	160	—		
t _{d(off)}	Turn-Off Delay Time	—	116	—		
t _f	Fall Time	—	192	—		
C _{iss}	Input Capacitance	—	8292	—	pF	V _{GS} = 0V V _{DS} = 10V f = 1.0MHz
C _{oss}	Output Capacitance	—	2012	—		
C _{rss}	Reverse Transfer Capacitance	—	1526	—		

Diode Characteristics

	Parameter	Min.	Typ.	Max.	Units	Conditions
I _S	Continuous Source Current (Body Diode)	—	—	211	A	MOSFET symbol showing the integral reverse p-n junction diode. 
I _{SM}	Pulsed Source Current (Body Diode) ⑤	—	—	305		
V _{SD}	Diode Forward Voltage	—	—	1.2	V	T _J = 25°C, I _S = 30A, V _{GS} = 0V ⑦
t _{rr}	Reverse Recovery Time	—	48	72	ns	T _J = 25°C, I _F = 30A, V _{DD} = 10V
Q _{rr}	Reverse Recovery Charge	—	84	126	nC	di/dt = 200A/μs ⑦

Notes:

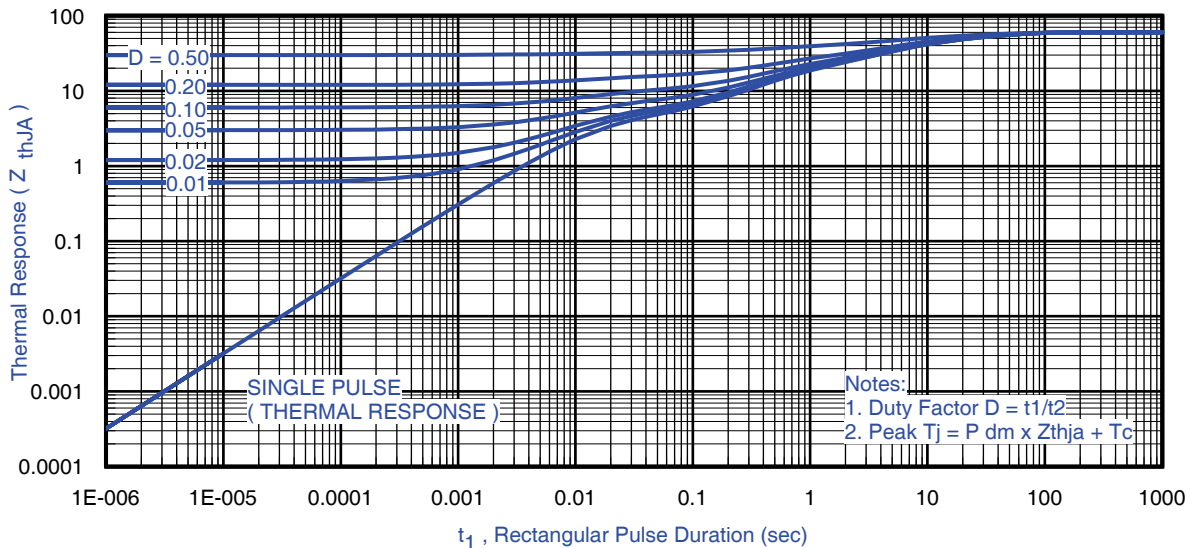
- ⑤ Repetitive rating; pulse width limited by max. junction temperature.
- ⑦ Pulse width ≤ 400μs; duty cycle ≤ 2%.

Absolute Maximum Ratings

	Parameter	Max.	Units
$P_D @ T_A = 25^\circ\text{C}$	Power Dissipation ③	2.1	W
$P_D @ T_A = 70^\circ\text{C}$	Power Dissipation ③	1.3	
$P_D @ T_C = 25^\circ\text{C}$	Power Dissipation ④	63	
T_P	Peak Soldering Temperature	270	°C
T_J	Operating Junction and	-40 to + 150	
T_{STG}	Storage Temperature Range		

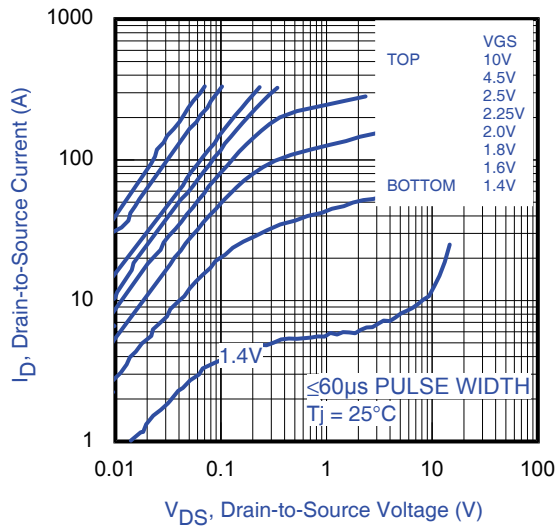
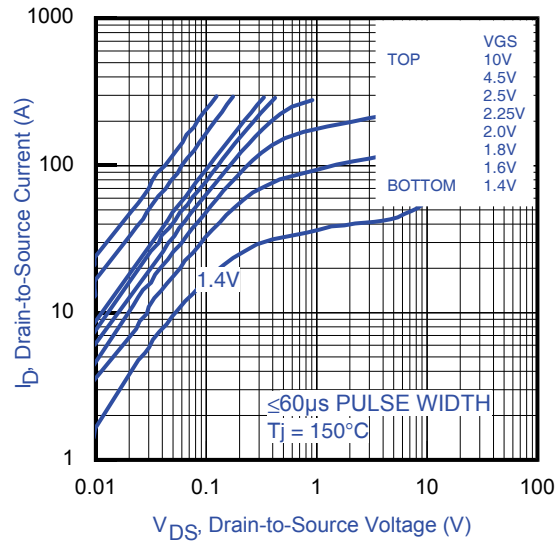
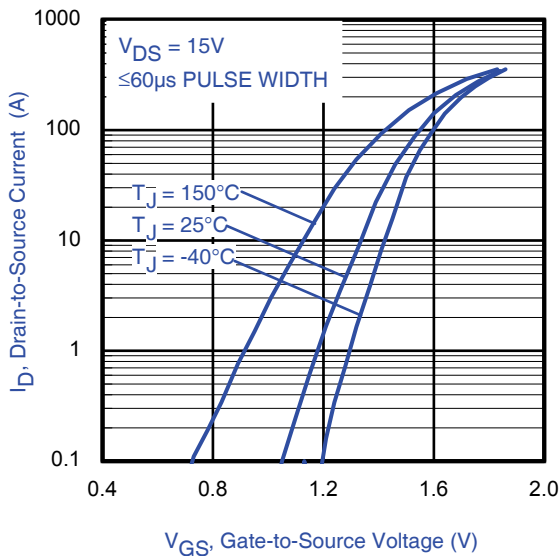
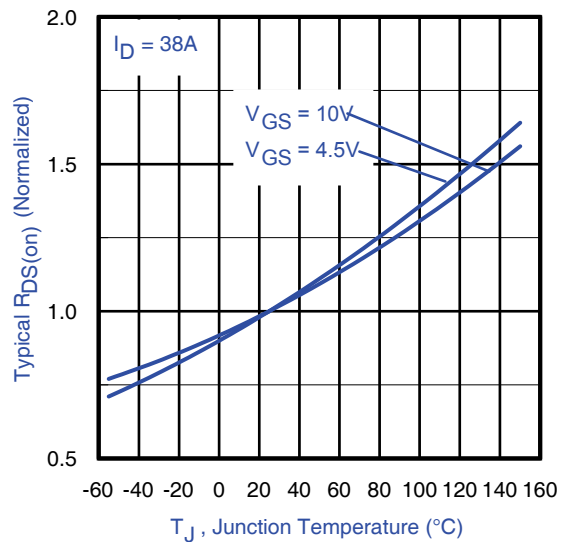
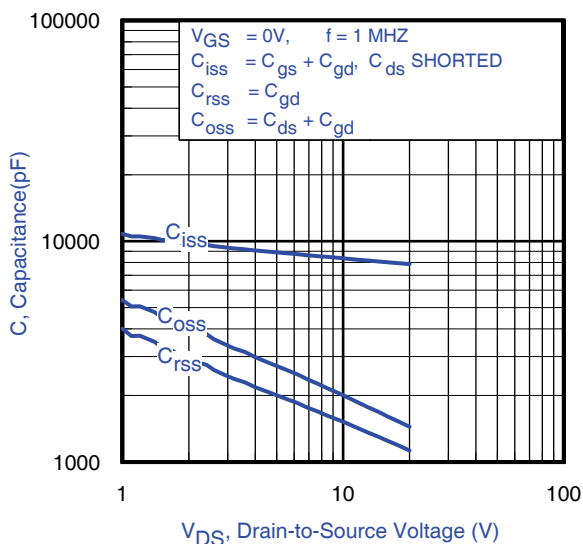
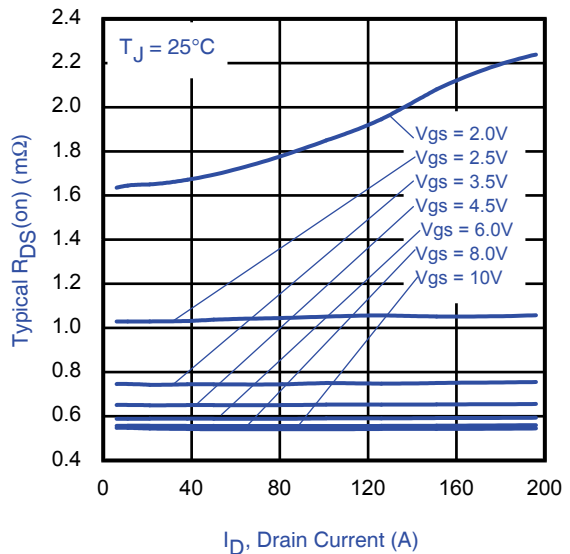
Thermal Resistance

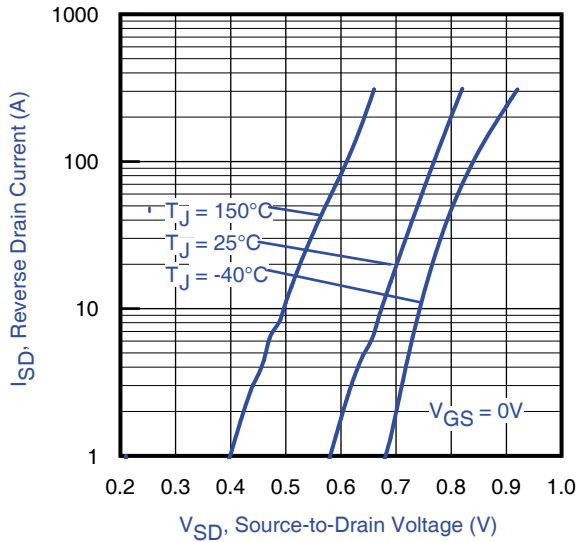
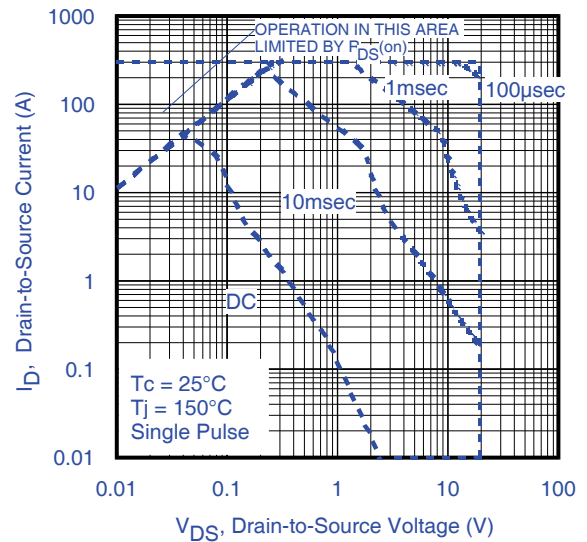
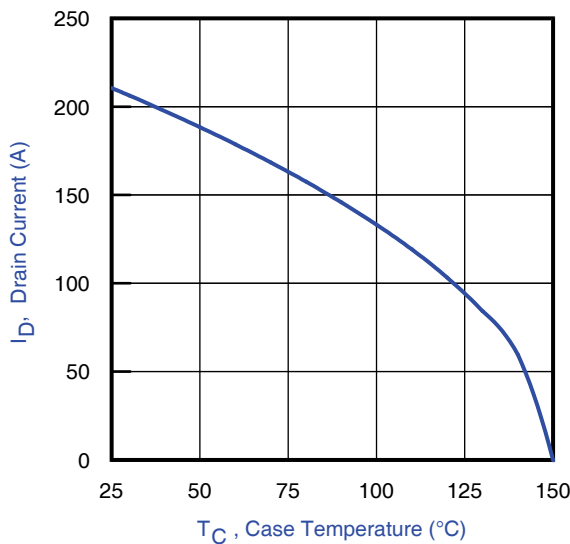
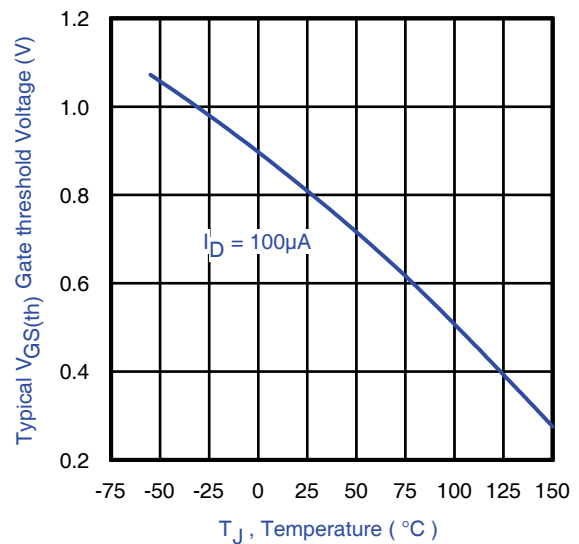
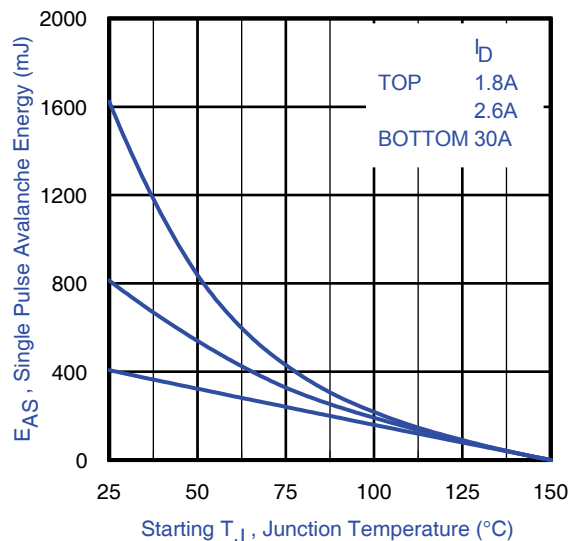
	Parameter	Typ.	Max.	Units
$R_{\theta JA}$	Junction-to-Ambient ③	—	60	°C/W
$R_{\theta JA}$	Junction-to-Ambient ⑧	12.5	—	
$R_{\theta JA}$	Junction-to-Ambient ⑨	20	—	
$R_{\theta JC}$	Junction-to-Case ④⑩	—	1.97	
$R_{\theta J-PCB}$	Junction-to-PCB Mounted	1.0	—	
	Linear Derating Factor ③	0.02		W/°C

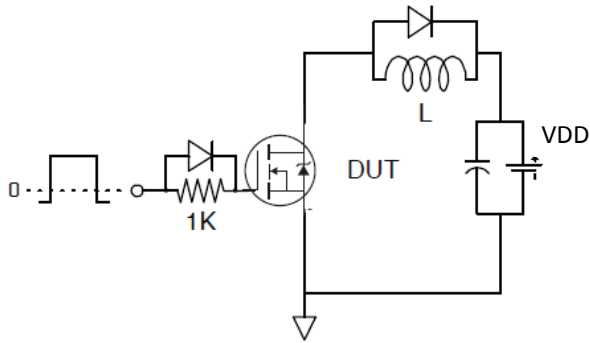
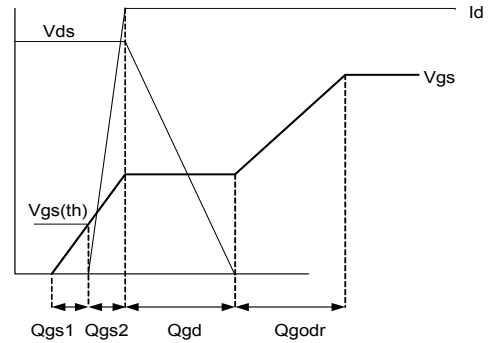
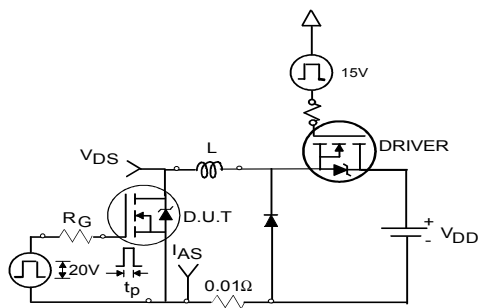
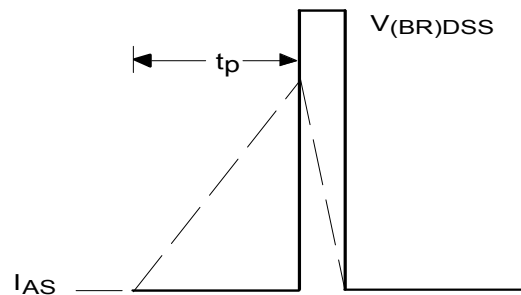
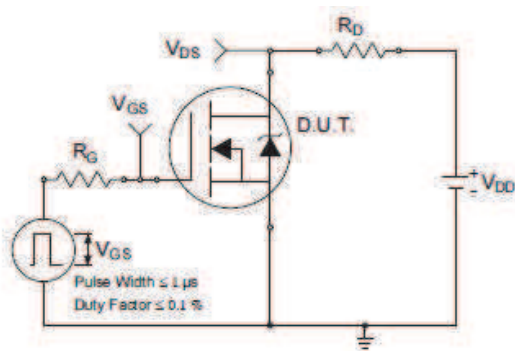
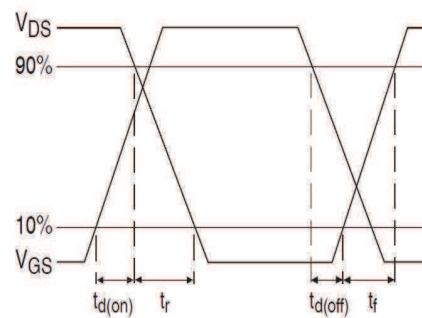

Fig 3. Maximum Effective Transient Thermal Impedance, Junction-to-Ambient ③


- ③ Surface mounted on 1 in. square Cu board, steady state.
- ④ T_c measured with thermocouple mounted to top (Drain) of part.
- ⑧ Used double sided cooling, mounting pad with large heat sink.

- ⑨ Mounted on minimum footprint full size board with metalized back and with small clip heat sink.
- ⑩ R_{θ} is measured at T_J of approximately 90°C .


Fig 4. Typical Output Characteristics

Fig 5. Typical Output Characteristics

Fig 6. Typical Transfer Characteristics

Fig 7. Normalized On-Resistance vs. Temperature

Fig 8. Typical Capacitance vs. Drain-to-Source Voltage

Fig 9. Typical On-Resistance vs. Drain Current and Voltage


Fig 10. Typical Source-Drain Diode Forward Voltage

Fig 11. Maximum Safe Operating Area

Fig 12. Maximum Drain Current vs. Case Temperature

Fig 13. Typical Threshold Voltage vs. Junction Temperature

Fig 14. Maximum Avalanche Energy vs. Drain Current


Fig 15a. Gate Charge Test Circuit

Fig 15b. Gate Charge Waveform

Fig 16a. Unclamped Inductive Test Circuit

Fig 16b. Unclamped Inductive Waveforms

Fig 17a. Switching Time Test Circuit

Fig 17b. Switching Time Waveforms

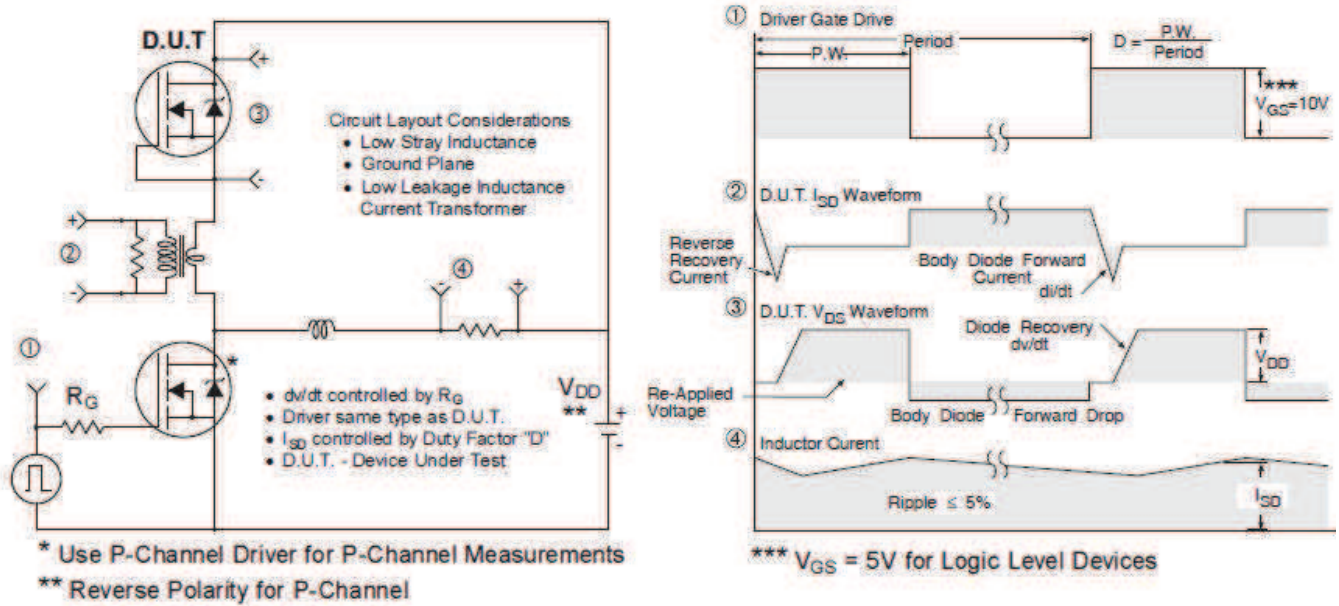
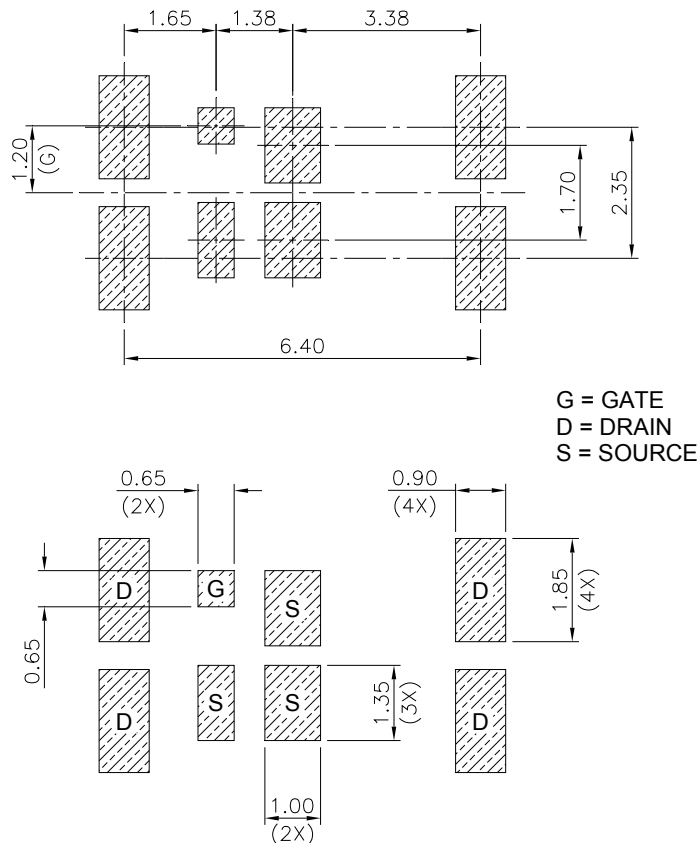


Fig 18. Peak Diode Recovery dv/dt Test Circuit for N-Channel HEXFET[®] Power MOSFETs

DirectFET[®] Board Footprint, MD Outline (Medium Size Can, D-Designation).

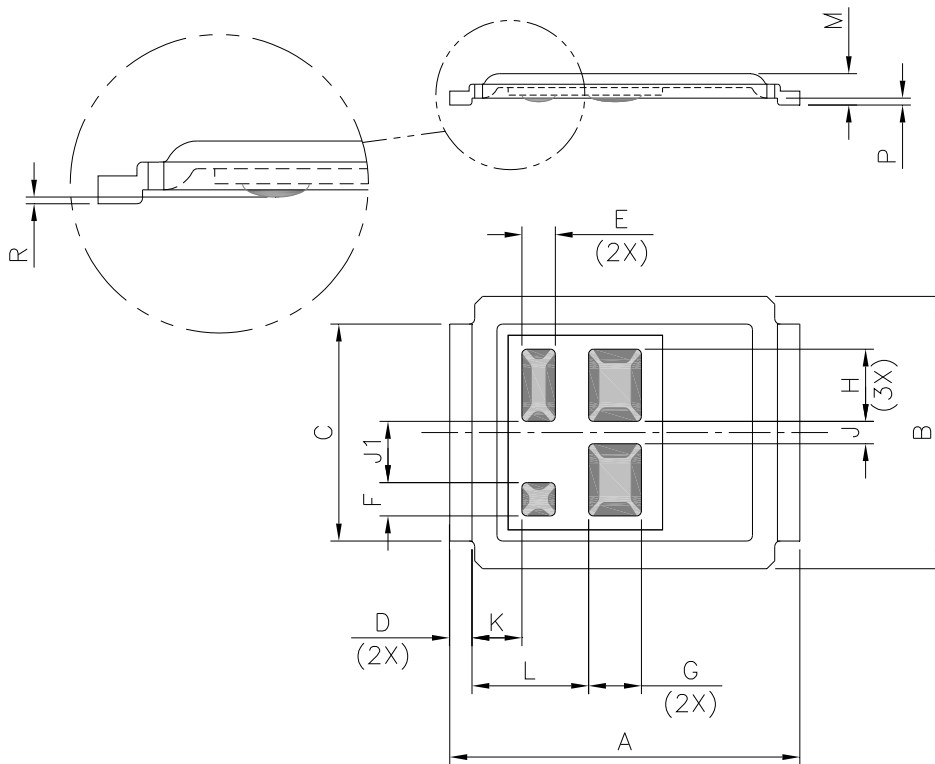
Please see DirectFET application note AN-1035 for all details regarding the assembly of DirectFET. This includes all recommendations for stencil and substrate designs.



Note: For the most current drawing please refer to IR website at <http://www.irf.com/package/>

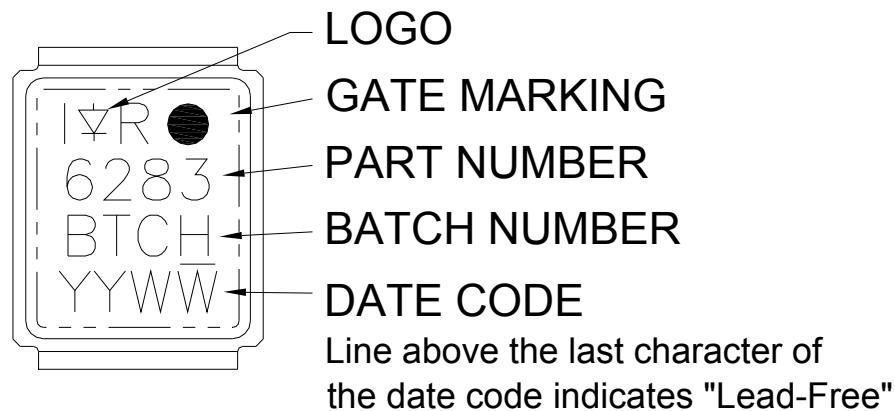
**DirectFET® Outline Dimension, MD Outline
(Medium Size Can, D-Designation).**

Please see DirectFET application note AN-1035 for all details regarding the assembly of DirectFET. This includes all recommendations for stencil and substrate designs.

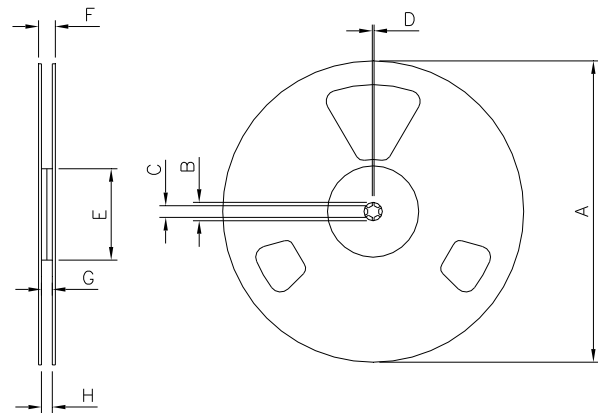
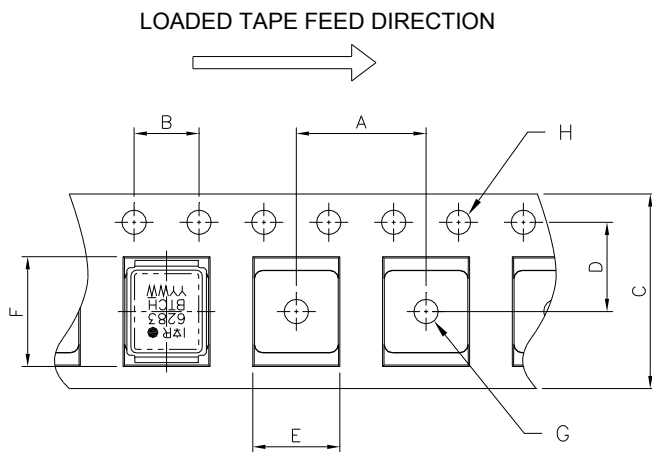


CODE	METRIC		IMPERIAL	
	MIN	MAX	MIN	MAX
A	6.25	6.35	0.246	0.250
B	4.80	5.05	0.189	0.199
C	3.85	3.95	0.152	0.156
D	0.35	0.45	0.014	0.018
E	0.58	0.62	0.023	0.024
F	0.58	0.62	0.023	0.024
G	0.93	0.97	0.037	0.038
H	1.28	1.32	0.050	0.052
J	0.38	0.42	0.015	0.017
J1	1.08	1.12	0.043	0.044
K	0.88	0.92	0.035	0.036
L	2.08	2.12	0.082	0.083
M	0.535	0.595	0.021	0.023
R	0.02	0.08	0.0008	0.0031
P	0.08	0.17	0.003	0.007

Dimensions are shown in millimeters (inches)

DirectFET® Part Marking


Note: For the most current drawing please refer to IR website at <http://www.irf.com/package/>

DirectFET® Tape & Reel Dimension (Showing component orientation).


NOTE: Controlling dimensions in mm
Std reel quantity is 4800 parts. (ordered as IRL6283MTRPbF). For 1000 parts on 7" reel, order IRL6283MTR1PbF

NOTE: CONTROLLING DIMENSIONS IN MM

CODE	DIMENSIONS		DIMENSIONS	
	MIN	MAX	MIN	MAX
A	7.90	8.10	0.311	0.319
B	3.90	4.10	0.154	0.161
C	11.90	12.30	0.469	0.484
D	5.45	5.55	0.215	0.219
E	5.10	5.30	0.201	0.209
F	6.50	6.70	0.256	0.264
G	1.50	N.C	0.059	N.C
H	1.50	1.60	0.059	0.063

REEL DIMENSIONS								
CODE	STANDARD OPTION (QTY 4800)				TR1 OPTION (QTY 1000)			
	METRIC		IMPERIAL		METRIC		IMPERIAL	
A	330.0	N.C	12.992	N.C	177.77	N.C	6.9	N.C
B	20.2	N.C	0.795	N.C	19.06	N.C	0.75	N.C
C	12.8	13.2	0.504	0.520	13.5	12.8	0.53	0.50
D	1.5	N.C	0.059	N.C	1.5	N.C	0.059	N.C
E	100.0	N.C	3.937	N.C	58.72	N.C	2.31	N.C
F	N.C	18.4	N.C	0.724	N.C	13.50	N.C	0.53
G	12.4	14.4	0.488	0.567	11.9	12.01	0.47	N.C
H	11.9	15.4	0.469	0.606	11.9	12.01	0.47	N.C

Note: For the most current drawing please refer to IR website at <http://www.irf.com/package/>

Qualification Information†

Moisture Sensitivity Level	DirectFET	MSL1 (per JEDEC J-STD-020D††)
RoHS Compliant	Yes	

† Qualification standards can be found at International Rectifier's web site

<http://www.irf.com/product-info/reliability/>

†† Applicable version of JEDEC standard at the time of product release.

Revision History

Date	Comments
2/4/2014	<ul style="list-style-type: none"> Converted the data sheet to StrongIRFET template. Updated the schematic drawing, on page 1.
9/24/2014	<ul style="list-style-type: none"> Updated notes on page 2 & page 3