

# iC-SM2L

LINEAR AMR SENSOR (2 mm)



Rev C1, Page 1/8

## FEATURES

- ◆ Magneto resistive position sensor based on the AMR effect
- ◆ Strong field sensor for 2 mm N/S pole pitch
- ◆ One sine/cosine cycle per pole width (averaged using a pair of N/S poles)
- ◆ High interpolation due to a sine signal with few harmonics
- ◆ Low saturation field strength
- ◆ High amplitude consistency with changes in distance
- ◆ Resistant to strong magnetic fields
- ◆ Not sensitive to external homogenous magnetic fields
- ◆ Small SMT capable package

## APPLICATIONS

- ◆ Linear position sensing
- ◆ Length measuring systems
- ◆ Off-axis hollow shaft rotary encoders

## PACKAGES

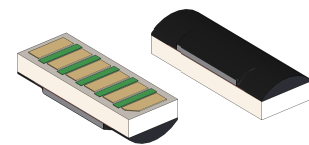

LGA SM2C  
7.6 mm x 2.8 mm x 1.8 mm  
RoHS compliant

## BLOCK DIAGRAM

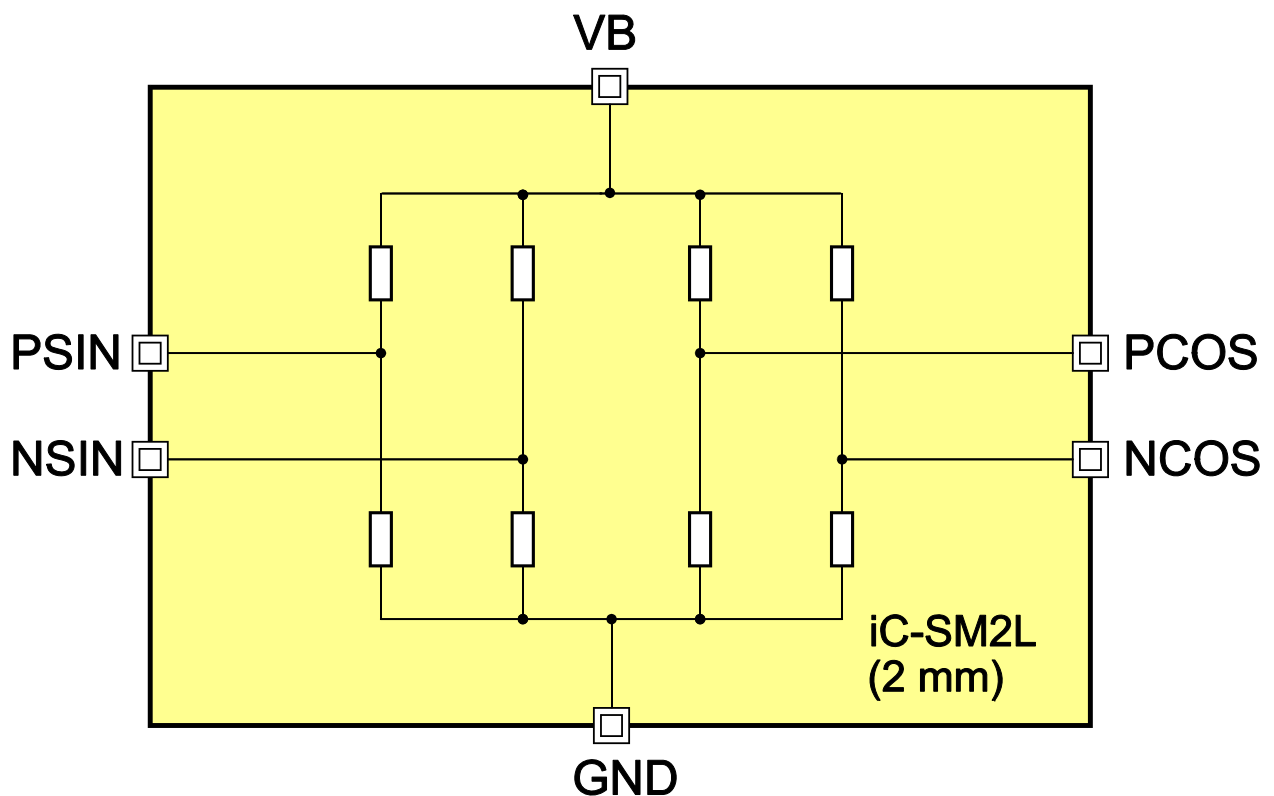

# iC-SM2L

## LINEAR AMR SENSOR (2 mm)



Rev C1, Page 2/8

### DESCRIPTION

iC-SM2L is a linear position sensor which operates on the AMR effect (anisotropic magneto resistance) and has been designed to work with magnetic scales which have a N/S pole pitch of 2 mm.

When the Sensor is moved along a magnetic scale with a N/S pole pitch of 2mm the two Wheatstone bridges generate differential sinusoidal output voltages (PSIN - NSIN) and (PCOS - NCOS) phase-shifted at 90°. One sine/cosine cycle averaged using a pair of N/S poles is thus produced for a pole

width. The absolute magnetic field strength must be large enough for the sensor to go into saturation and for the magnetization of iC-SM2L's resistor stripes to assume the direction of the outer magnetic fields.

The amplitudes of the differential output voltages are largely independent of the magnetic field strength and thus not sensitive to changes in distance.

iC-SM2L is resistant to strong magnetic fields and not sensitive to external homogenous magnetic fields.

### PACKAGING INFORMATION

#### PIN CONFIGURATION

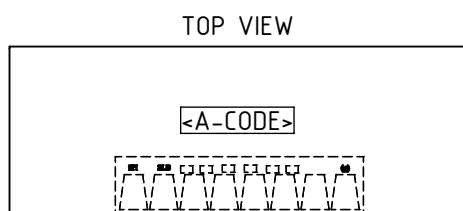
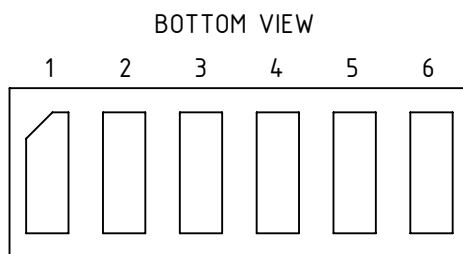

#### PIN FUNCTIONS

##### No. Name Function

1	NCOS	Inverted Cosine Output
2	PCOS	Noninverted Cosine Output
3	VCC	Supply Voltage
4	GND	Ground
5	NSIN	Inverted Sine Output
6	PSIN	Noninverted Sine Output

IC top marking: <A-CODE> = assembly code (subject to changes).

# iC-SM2L

## LINEAR AMR SENSOR (2 mm)

### PACKAGE DIMENSIONS

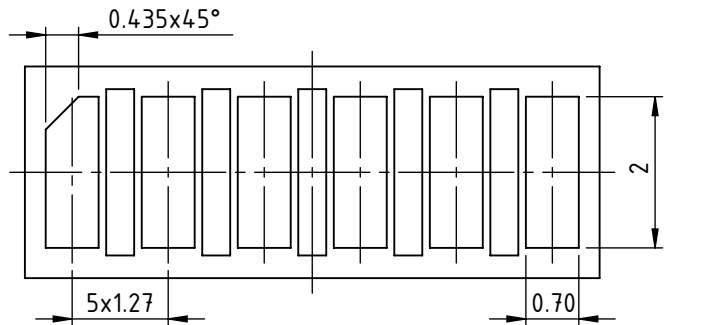

BOTTOM

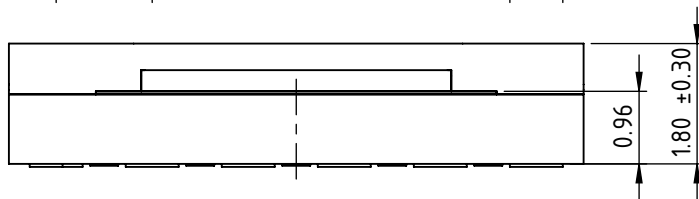

SIDE

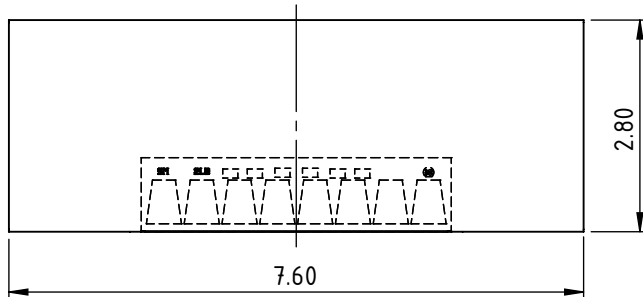
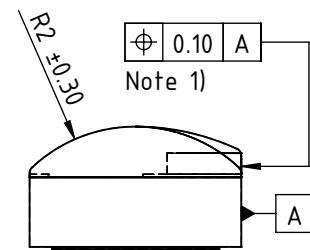

TOP

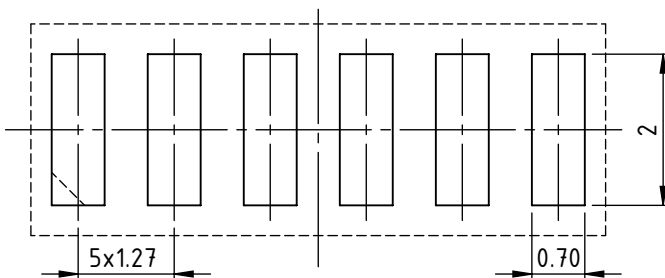
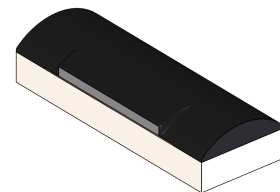

RECOMMENDED  
PCB-FOOTPRINT

Note 1):

- Caution: Do not touch exposed sensor edge.
- Sensor edge can be set back or overhang by up to 0.05 mm vs. substrate edge.

All dimensions given in mm. General tolerances according to ISO-2768-mK  
Position tolerance of sensor pattern:  $\pm 0.20$  mm /  $\pm 1^\circ$  (with respect to backside pads).

# iC-SM2L

## LINEAR AMR SENSOR (2 mm)



Rev C1, Page 4/8

### ABSOLUTE MAXIMUM RATINGS

These ratings do not imply operating conditions; functional operation is not guaranteed. Beyond these ratings device damage may occur.

Item No.	Symbol	Parameter	Conditions			Unit
				Min.	Max.	
G001	V()	Voltage at VB		-10	10	V
G002	V()	Voltage at PSIN, NSIN, PCOS, NCOS		-10	10	V
G003	I()	Current in VB		-11	11	mA
G004	I()	Current in PSIN, NSIN, PCOS, NCOS		-11	11	mA
G005	T <sub>j</sub>	Junction Temperature		-40	125	°C
G006	T <sub>s</sub>	Chip Storage Temperature		-40	125	°C

### THERMAL DATA

Operating conditions: VB = 5V ±10 %

Item No.	Symbol	Parameter	Conditions				Unit
				Min.	Typ.	Max.	
T01	Ta	Operating Ambient Temperature Range	package LGA SM2C - standard temperature range - option ET: extended temperature range	-20		90	°C
				-40		125	°C
T02	T <sub>s</sub>	Storage Temperature Range	package LGA SM2C	-40		125	°C
T03	T <sub>I</sub>	Soldering Peak Temperature	package LGA SM2C  <i>t<sub>pk</sub></i> < 20 s, convection reflow <i>t<sub>pk</sub></i> < 20 s, vapour phase  TOL (time on label) 8 h; please refer to customer information file No. 7 for details			260	°C
						230	°C

All voltages are referenced to ground unless otherwise stated.

All currents flowing into the device pins are positive; all currents flowing out of the device pins are negative.

# iC-SM2L

## LINEAR AMR SENSOR (2 mm)



Rev C1, Page 5/8

### ELECTRICAL CHARACTERISTICS

Operating Conditions:

$V_B = 5\text{ V} \pm 10\%$ ,  $T_j = -40 \dots 125\text{ }^\circ\text{C}$ ,  $|H_{ext}| > 25\text{ kA/m}$  at the bottom edge of the sensor, unless otherwise noted

Item No.	Symbol	Parameter	Conditions	Min.	Typ.	Max.	Unit
<b>Total Device</b>							
001	$V_B$	Permissible Supply Voltage $V_B$		-8		8	V
002	$I()$	Supply Current in $V_B$	$T_j = -40 \dots 90\text{ }^\circ\text{C}$ $T_j = -40 \dots 125\text{ }^\circ\text{C}$ PSIN, NSIN, PCOS, NCOS open	3.4 2.5		7.0 7.0	mA mA
003	$R()$	Bridge Resistance of one sine/cosine bridge	$T_j = 25\text{ }^\circ\text{C}$	1.8		2.6	k $\Omega$
004	$TC(R)$	Bridge Resistance Temperature Coefficient		0.27	0.32	0.37	%/K
005	$V_{pk}$	Amplitude of Differential Output Voltages		8		20	mV/V
006	$TC(V_{pk})$	Amplitude Temperature Coefficient		-0.4		-0.25	%/K
007	$V_{os}$	Diff. Output Offset Voltage	$H_{ext} = 0\text{ kA/m}$ at the bottom edge of the sensor	-2		2	mV/V
008	$TC(V_{os})$	Offset Voltage Temperature Coefficient		-3		3	$\mu\text{V/V/K}$
009	$V_{rel}$	Relative Change in Amplitude	distance bottom edge of the sensor to the magnetic scale: 0 ... 1.5 mm	-5		5	%
010	AAabs	Absolute Angle Accuracy	without offset voltage, distance bottom edge of the sensor to the magnetic scale: 0.5 mm	-1		1	DEG

### APPLICATION INFORMATION

iC-SM2L is placed vertically above a magnetic scale with an equal distribution of N/S pole pairs.

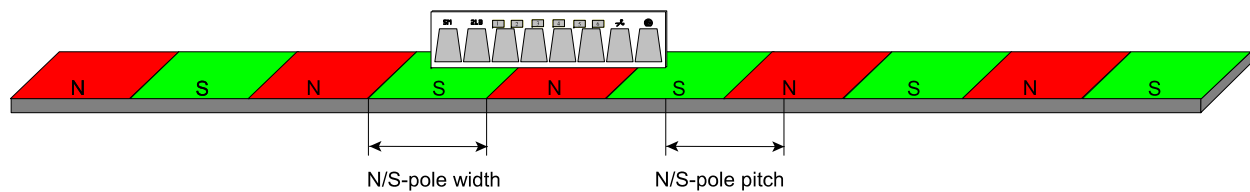

Figure 1: Placement of the iC-SM2L to a magnetic scale

**APPLICATION INFORMATION: Handling**



Figure 2: Handling instruction: **NOT OK.**

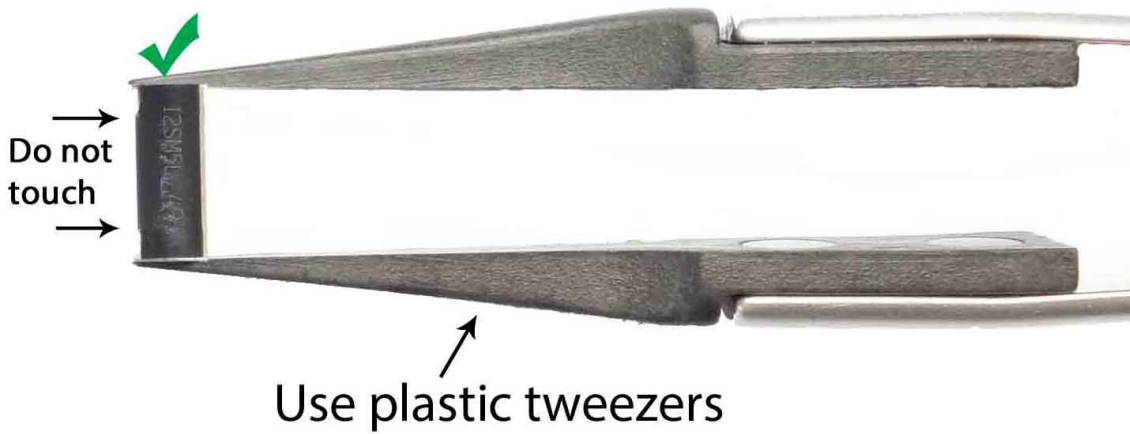

Figure 3: Handling instruction: **OK.**

# iC-SM2L

## LINEAR AMR SENSOR (2 mm)



Rev C1, Page 7/8

### REVISION HISTORY

Rel.	Rel. Date*	Chapter	Modification	Page
B1	14-07-04		Datasheet replaces former iC-SM2L datasheet release A2 and package datasheet LGA SM2C release A3.	all

Rel.	Rel. Date*	Chapter	Modification	Page
B2	14-10-14		All package Figures updated	1 - 3

Rel.	Rel. Date*	Chapter	Modification	Page
C1	2015-11-17	THERMAL DATA	Extended operating temperature as available option	4
		ORDERING INFORMATION	Ordering code for extended operating temperature range	8
		ELECTRICAL CHARACTERISTICS	Item 002 expanded for standard and extended temperatur range	5

iC-Haus expressly reserves the right to change its products and/or specifications. An info letter gives details as to any amendments and additions made to the relevant current specifications on our internet website [www.ichaus.com/infoletter](http://www.ichaus.com/infoletter); this letter is generated automatically and shall be sent to registered users by email.

Copying – even as an excerpt – is only permitted with iC-Haus' approval in writing and precise reference to source.

iC-Haus does not warrant the accuracy, completeness or timeliness of the specification and does not assume liability for any errors or omissions in these materials.

The data specified is intended solely for the purpose of product description. No representations or warranties, either express or implied, of merchantability, fitness for a particular purpose or of any other nature are made hereunder with respect to information/specification or the products to which information refers and no guarantee with respect to compliance to the intended use is given. In particular, this also applies to the stated possible applications or areas of applications of the product.

iC-Haus products are not designed for and must not be used in connection with any applications where the failure of such products would reasonably be expected to result in significant personal injury or death (*Safety-Critical Applications*) without iC-Haus' specific written consent. Safety-Critical Applications include, without limitation, life support devices and systems. iC-Haus products are not designed nor intended for use in military or aerospace applications or environments or in automotive applications unless specifically designated for such use by iC-Haus.

iC-Haus conveys no patent, copyright, mask work right or other trade mark right to this product. iC-Haus assumes no liability for any patent and/or other trade mark rights of a third party resulting from processing or handling of the product and/or any other use of the product.

\* Release Date format: YYYY-MM-DD

# iC-SM2L

LINEAR AMR SENSOR (2 mm)



Rev C1, Page 8/8

## ORDERING INFORMATION

Type	Package	Options	Order Designation
iC-SM2L	6-pin LGA SM2C, 7.6 mm x 2.8 mm, thickness 1.8 mm RoHS compliant	standard	iC-SM2L LGA SM2C
		extended operating temperatur range	iC-SM2L LGA SM2C ET -40/125

Please send your purchase orders to our order handling team:

**Fax: +49 (0) 61 35 - 92 92 - 692**  
**E-Mail: [dispo@ichaus.com](mailto:dispo@ichaus.com)**

For technical support, information about prices and terms of delivery please contact:

**iC-Haus GmbH**  
**Am Kuemmerling 18**  
**D-55294 Bodenheim**  
**GERMANY**

**Tel.: +49 (0) 61 35 - 92 92 - 0**  
**Fax: +49 (0) 61 35 - 92 92 - 192**  
**Web: <http://www.ichaus.com>**  
**E-Mail: [sales@ichaus.com](mailto:sales@ichaus.com)**

**Appointed local distributors: [http://www.ichaus.com/sales\\_partners](http://www.ichaus.com/sales_partners)**