

IEC Appliance Inlet C20 with Line Switch, 2-pole



Snap-In Version or Screw-On Version
 illuminated version



Approvals and Compliances

Description

- Panel Mount :
 Screw-on version from front or rear side, snap-in version from front side
- 2 Functions :
 Appliance Inlet Protection class I , Line Switch 2-pole
- Quick connect terminals 6.3 x 0.8 mm

Characteristics

- All single elements are already wired
- Unwired versions available on request
- Line switch non-illuminated or illuminated
- Ideal for application with high transient loads
- Suitable for use in equipment according to IEC/UL 60950

Other versions on request

- Unwired versions
- Line switch with other rocker marking
- For protection class II
- Variant with notch for V-Lock mating Cordsets

References

Alternative: version with line filter [EC12](#)

Weblinks

[pdf datasheet](#), [html-datasheet](#), [General Product Information](#), [Distributor Stock-Check](#), [Accessories](#), [Detailed request for product](#), [Microsite](#)

Newly available variants corresponding to V-Lock mating cordset. The connector is equipped with a notch intended for use with the latching cordset. The cord latching system prevents against accidental removal of the cordset.

Technical Data

Ratings IEC	16A / 250VAC; 50Hz	appliance inlet/-outlet	C20 acc. to IEC 60320-1, UL 498, CSA C22.2 no. 42 (for cold conditions) pin-temperature 70 °C, 16A, Protection Class I
Ratings UL/CSA	20A / 250VAC; 60Hz	Line Switch	Rocker switch 2-pole, non-illuminated or illuminated, acc. to IEC 61058-1 Technical Details
Dielectric Strength	> 2.5 kVAC between L-N > 3 kVAC between L/N-PE (1 min/50Hz)		
Allowable Operation Temperature	-25 °C to 70 °C		
IP-Protection	from front side IP 40 acc. to IEC 60529		
Insulation cover	Suitable for appliances with protection class I acc. to IEC 61140		
Terminal	Quick connect terminals 6.3 x 0.8 mm		
Panel Thickness S	Screw: max 8 mm Mounting screw torque max 0.5Nm Snap-in: 1.5/2/2.5 mm		
Material: Housing	Thermoplastic, black, UL 94V-0		



Approvals and Compliances

Detailed information on product approvals, code requirements, usage instructions and detailed test conditions can be looked up in [Details about Approvals](#)

Approvals





The approval mark is used by the testing authorities to certify compliance with the safety requirements placed on electronic products.

Approval Reference Type: EC11

Approval Logo	Certificates	Certification Body	Description
	VDE Approvals	VDE	Certificate Number: 40001031
	UL Approvals	UL	UL File Number: E96454
	CQC Approvals	CQC	CCC File Number: 2014010204683955



Product standards

Product standards that are referenced

Organization	Design	Standard	Description
	Designed according to	IEC 60320-1	Appliance couplers for household and similar general purposes
	Designed according to	IEC 61058-1	Switches for appliances. Part 1. General requirements
	Designed according to	UL 498	Standard for Attachment Plugs and Receptacles
	Designed according to	CSA C22.2 no. 42	General Use Receptacles, Attachment Plugs, and Similar Wiring Devices





Application standards

Application standards where the product can be used

Organization	Design	Standard	Description
	Designed for applications acc.	IEC/UL 60950	IEC 60950-1 includes the basic requirements for the safety of information technology equipment.
	Designed for applications acc.	IEC 60335-1	Safety of electrical appliances for household and similar purposes. Meets the requirements for appliances in unattended use. This includes the enhanced requirements of glow wire tests acc. to IEC 60695-2-12 and -13.

Compliances

The product complies with following Guide Lines

Identification	Details	Initiator	Description
	CE declaration of conformity	SCHURTER AG	The CE marking declares that the product complies with the applicable requirements laid down in the harmonisation of Community legislation on its affixing in accordance with EU Regulation 765/2008.
	RoHS	SCHURTER AG	EU Directive RoHS 2011/65/EU
	China RoHS	SCHURTER AG	The law SJ / T 11363-2006 (China RoHS) has been in force since 1 March 2007. It is similar to the EU directive RoHS.
	REACH	SCHURTER AG	On 1 June 2007, Regulation (EC) No 1907/2006 on the Registration, Evaluation, Authorization and Restriction of Chemicals 1 (abbreviated as "REACH") entered into force.
	MicrositeV-Lock	SCHURTER AG	V-Lock system are based on a matching plug-dose combination. The connector is equipped with a notch intended for use with the latching cordset. The cord latching system prevents against accidental removal of the cordset.

Dimensions [mm]

Screw-on mounting

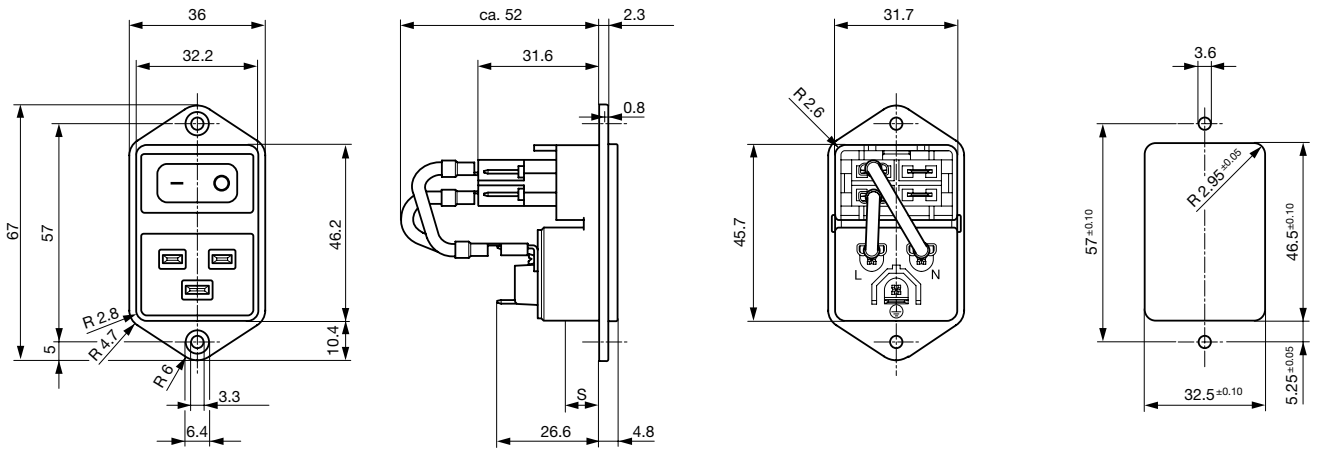

Snap-in mounting

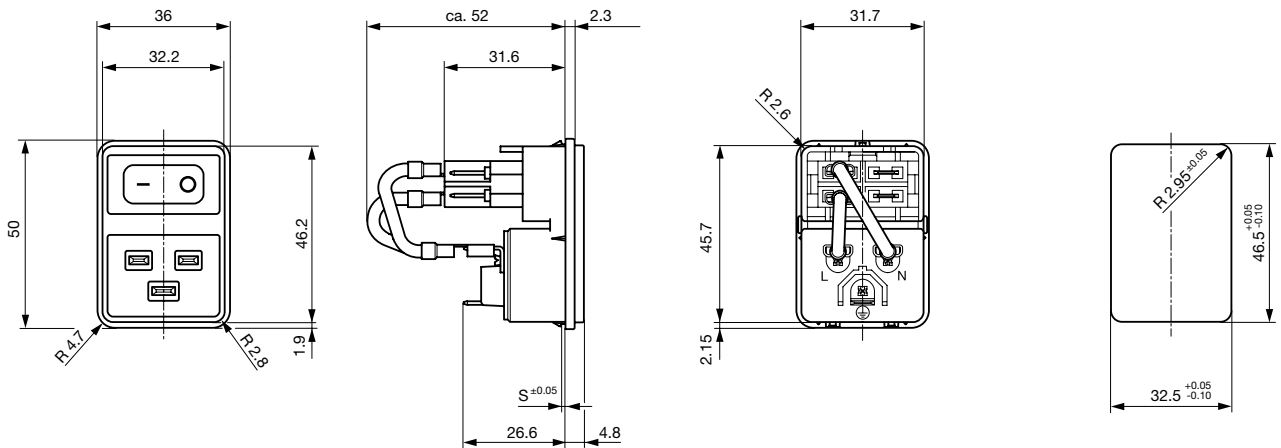

Diagrams

Line switch non-illuminated

Line switch illuminated

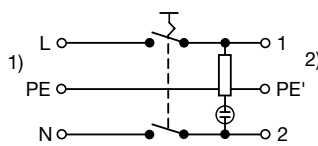
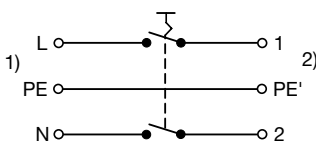

1) Line
2) Load

1) Line
2) Load

All Variants

Panel mounting	Panel Thickness s [mm]	Illumination	Color	Internally wired	V-Lock	Order Number
Snap-in	1.5	-	-	●		EC11.0001.201
Snap-in	1.5	-	-			EC11.0001.202
Snap-in	1.5	●	red	●		EC11.0021.201
Snap-in	1.5	●	red			EC11.0021.202
Snap-in	1.5	●	green	●		EC11.0031.201
Snap-in	1.5	●	green			EC11.0031.202

Panel mounting	Panel Thickness s [mm]	Illumination	Color	Internally wired	V-Lock	Order Number
Snap-in	2		-	●		EC11.0001.301 ■
Snap-in	2		-	●	●	EC11.0001.301.21
Snap-in	2		-			EC11.0001.302
Snap-in	2	●	red	●		EC11.0021.301
Snap-in	2	●	red			EC11.0021.302
Snap-in	2	●	green	●		EC11.0031.301
Snap-in	2	●	green			EC11.0031.302
Snap-in	2.5		-	●		EC11.0001.401
Snap-in	2.5		-			EC11.0001.402
Snap-in	2.5	●	red	●		EC11.0021.401
Snap-in	2.5	●	red			EC11.0021.402
Snap-in	2.5	●	green	●		EC11.0031.401
Snap-in	2.5	●	green			EC11.0031.402
Screw	-		-	●	●	EC11.0001.001.21
Screw	-		-			EC11.0001.002
Screw	-	●	red	●		EC11.0021.001 ■
Screw	-	●	red			EC11.0021.002
Screw	-	●	green	●		EC11.0031.001 ■
Screw	-	●	green			EC11.0031.002

■ Most Popular.

Availability for all products can be searched real-time: <https://www.schurter.com/en/Stock-Check/Stock-Check-SCHURTER>

Packaging unit 25 Pcs

Accessories

Description



Wire Harness
Wire harness for SCHURTER products

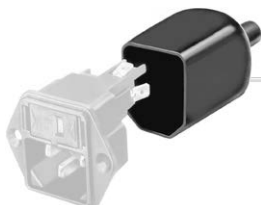

Assorted Covers
Rear Cover

0859.0076



Cord retaining kits
Cord retaining strain relief

Flat head, H

4700.0008

Mating Outlets/Connectors

Category / Description



[Connector Overview complete](#)

IEC Connector C19, Rewireable, Straight	4795
IEC Connector C19, Rewireable, Angled	4790
IEC Connector C19, Rewireable, Straight	0104U

[Connector further types to EC11](#)

[Power Supply Cord Overview complete](#)



Cord Sets 10 A, North America, 3.0 m, Connector IEC C13, SJT 3x18 AWG, Transparent	4300.0920
Cord Sets 16 A, Europlug, 2.5 m, Connector IEC C19, H05VV-F3G1.5, black	6004.0395
Cord Sets 16 A, Interconnection, 1.0 m, Connector IEC C19, H05VV-F3G1.5, black	6020.0392
Cord Sets 16 A, Interconnection, 2.0 m, Connector IEC C19, H05VV-F3G1.5, black	6020.0394
Cord Sets 16 A, North America, 2.5 m, Connector IEC C19, SJT 3x14 AWG, black	6009.5195

[Power Supply Cord further types to EC11](#)

Mating Outlets/Connectors shuttered



[Power Cord Overview complete](#)

Overview Power Cord with IEC Appliance Connector C19, V-Lock, straight	VAC19KS
--	---------

[Power Cord further types to EC11](#)