

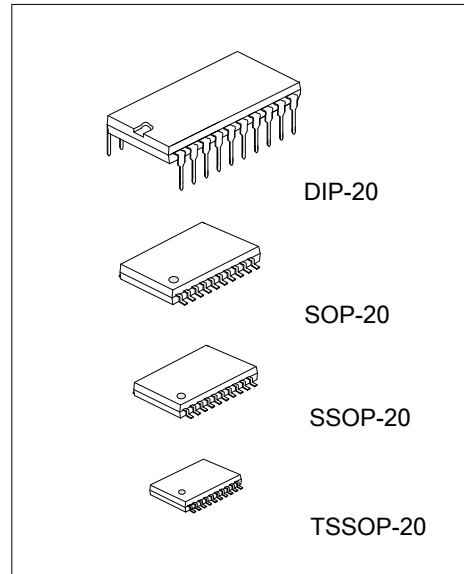

# U74HC573

**CMOS IC**

## OCTAL TRANSPARENT D-TYPE LATCHES WITH 3-STATE OUTPUTS



■ **DESCRIPTION**

The UTC **U74HC573** is a octal transparent D-type latch with 3-state outputs, and it has 8 channels.

■ **FEATURES**

- \* Operate from 2V to 6V
- \* Max  $t_{PD}$  of 57ns at 4.5 V
- \* Typical  $V_{OL} < 0.17V$  at  $V_{CC}=4.5V, T_A=25^\circ C$
- \* Typical  $V_{OH} > 4.3V$  at  $V_{CC}=4.5V, T_A=25^\circ C$

■ **ORDERING INFORMATION**

Ordering Number		Package	Packing
Lead Free	Halogen Free		
U74HC573L-D20-T	U74HC573G-D20-T	DIP-20	Tube
-	U74HC573G-S20-R	SOP-20	Tape Reel
-	U74HC573G-R20-R	SSOP-20	Tape Reel
-	U74HC573G-P20-R	TSSOP-20	Tape Reel

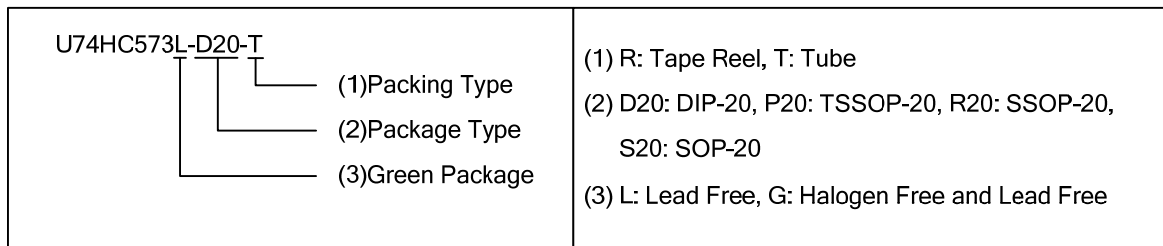

■ **MARKING**

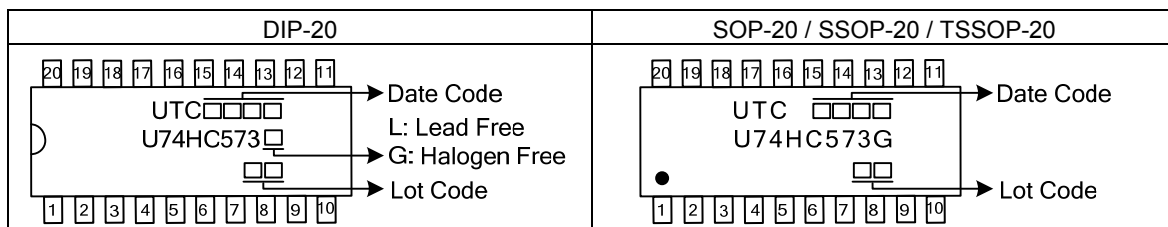

## PIN CONFIGURATION

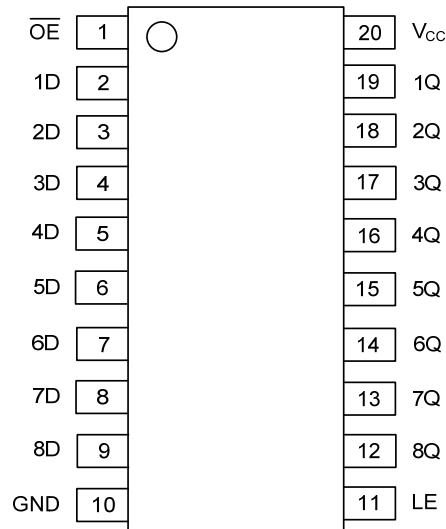

## FUNCTION TABLE

INPUTS( $\overline{OE}$ )	INPUTS(LE)	INPUTS(D)	OUTPUT(Q)
L	H	H	H
L	H	L	L
L	L	X	$Q_0$
H	X	X	Z

Note: H: HIGH voltage level; L: LOW voltage level.

## LOGIC SYMBOL

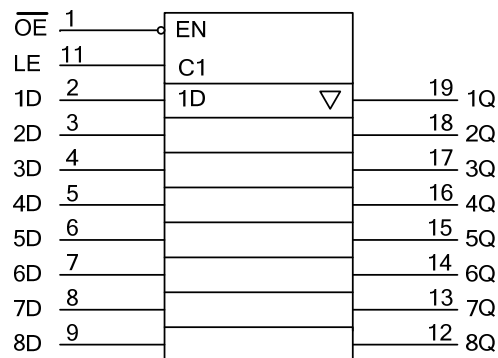

## LOGIC DIAGRAM

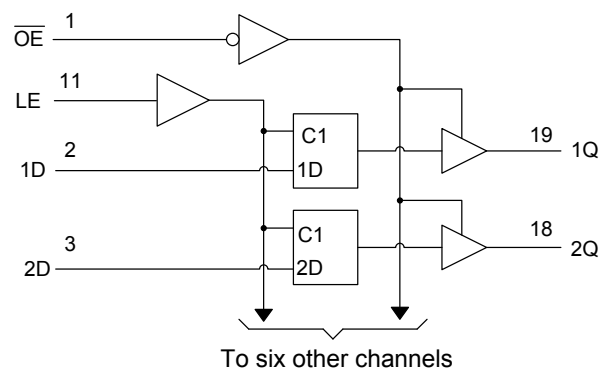

■ ABSOLUTE MAXIMUM RATING (T<sub>A</sub>=25°C, unless otherwise specified)

PARAMETER	SYMBOL	RATINGS	UNIT
Supply Voltage	V <sub>CC</sub>	-0.5 ~ 7	V
V <sub>CC</sub> or GND Current	I <sub>CC</sub>	±70	mA
Output Current	I <sub>OUT</sub>	±35	mA
Input Clamp Current	I <sub>IK</sub>	±20	mA
Output Clamp Current	I <sub>OK</sub>	±20	mA
Operating Temperature	T <sub>OPR</sub>	-40 ~ + 85	°C
Storage Temperature	T <sub>STG</sub>	-65 ~ + 150	°C

Note: Absolute maximum ratings are those values beyond which the device could be permanently damaged.  
 Absolute maximum ratings are stress ratings only and functional device operation is not implied.

■ THERMAL DATA

PARAMETER	SYMBOL	RATINGS	UNIT	
Junction to Ambient	DIP-20	θ <sub>JA</sub>	52	°C/W
	SOP-20		80	°C/W
	SSOP-20		96	°C/W
	TSSOP-20		103	°C/W

■ RECOMMENDED OPERATING CONDITIONS (T<sub>A</sub>=25°C, unless otherwise specified)

PARAMETER	SYMBOL	TEST CONDITIONS	MIN	TYP	MAX	UNIT
Supply Voltage	V <sub>CC</sub>		2	5	6	V
High-level Input Voltage	V <sub>IH</sub>	V <sub>CC</sub> =2.0V	1.5			V
		V <sub>CC</sub> =4.5V	3.15			V
		V <sub>CC</sub> =6.0V	4.2			V
Low-level Input Voltage	V <sub>IL</sub>	V <sub>CC</sub> =2.0V	0		0.5	V
		V <sub>CC</sub> =4.5V	0		1.35	V
		V <sub>CC</sub> =6.0V	0		1.8	V
Input Voltage	V <sub>IN</sub>		0		V <sub>CC</sub>	V
Output Voltage	V <sub>OUT</sub>	High or low state	0		V <sub>CC</sub>	V
Input Rise or Fall Times	t <sub>R</sub> , t <sub>F</sub>	V <sub>CC</sub> =2.0V	0		1	μs
		V <sub>CC</sub> =4.5V	0		0.5	μs
		V <sub>CC</sub> =6.0V	0		0.4	μs

■ ELECTRICAL CHARACTERISTICS (T<sub>A</sub>=25°C, unless otherwise specified)

PARAMETER	SYMBOL	TEST CONDITIONS	MIN	TYP	MAX	UNIT
Output Voltage High-Level	V <sub>OH</sub>	V <sub>CC</sub> =2.0V, I <sub>OH</sub> =-20μA	1.9	1.998		V
		V <sub>CC</sub> =4.5V, I <sub>OH</sub> =-20μA	4.4	4.499		V
		V <sub>CC</sub> =6.0V, I <sub>OH</sub> =-20μA	5.9	5.999		V
		V <sub>CC</sub> =4.5V, I <sub>OH</sub> =-6mA	3.98	4.3		V
		V <sub>CC</sub> =6.0V, I <sub>OH</sub> =-7.8mA	5.48	5.8		V
Output Voltage Low-Level	V <sub>OL</sub>	V <sub>CC</sub> =2.0V, I <sub>OL</sub> =20μA		2	100	mV
		V <sub>CC</sub> =4.5V, I <sub>OL</sub> =20μA		1	100	mV
		V <sub>CC</sub> =6.0V, I <sub>OL</sub> =20μA		1	100	mV
		V <sub>CC</sub> =4.5V, I <sub>OL</sub> =6mA		170	260	mV
		V <sub>CC</sub> =6.0V, I <sub>OL</sub> =7.8mA		150	260	mV
Input Leakage Current	I <sub>I(LEAK)</sub>	V <sub>CC</sub> =6.0V, V <sub>IN</sub> =V <sub>CC</sub> or GND		±0.1	±100	nA
Disable Output Leakage Current	I <sub>OZ</sub>	V <sub>CC</sub> =6.0V, V <sub>OUT</sub> =V <sub>CC</sub> or GND		±0.01	±0.5	μA
Quiescent Supply Current	I <sub>Q</sub>	V <sub>CC</sub> =6.0V, V <sub>IN</sub> =V <sub>CC</sub> or GND, I <sub>OUT</sub> =0			8	μA
Input Capacitance	C <sub>IN</sub>	V <sub>CC</sub> =2.0V~6.0V		3	10	pF

■ SWITCHING CHARACTERISTICS (See TEST CIRCUIT AND WAVEFORMS)

PARAMETER	SYMBOL	TEST CONDITIONS	MIN	TYP	MAX	UNIT
Propagation delay from input (D) to output (Q)	$t_{PLH}/t_{PHL}$	$V_{CC}=2.0V, C_L=50pF$		77	175	ns
		$V_{CC}=4.5V, C_L=50pF$		26	35	ns
		$V_{CC}=6.0V, C_L=50pF$		23	30	ns
		$V_{CC}=2.0V, C_L=150pF$		95	200	ns
		$V_{CC}=4.5V, C_L=150pF$		33	40	ns
		$V_{CC}=6.0V, C_L=150pF$		21	34	ns
Propagation delay from input (LE) to output (Q)		$V_{CC}=2.0V, C_L=50pF$		87	175	ns
		$V_{CC}=4.5V, C_L=50pF$		27	35	ns
		$V_{CC}=6.0V, C_L=50pF$		23	30	ns
		$V_{CC}=2.0V, C_L=150pF$		103	225	ns
		$V_{CC}=4.5V, C_L=150pF$		33	45	ns
		$V_{CC}=6.0V, C_L=150pF$		29	38	ns
Output enable time from input ( $\overline{OE}$ ) to output (Q)	$t_{PZL}/t_{PZH}$	$V_{CC}=2.0V, C_L=50pF$		68	150	ns
		$V_{CC}=4.5V, C_L=50pF$		24	30	ns
		$V_{CC}=6.0V, C_L=50pF$		21	26	ns
		$V_{CC}=2.0V, C_L=150pF$		85	200	ns
		$V_{CC}=4.5V, C_L=150pF$		29	40	ns
		$V_{CC}=6.0V, C_L=150pF$		26	34	ns
Output disable time from input ( $\overline{OE}$ ) to output (Q)	$t_{PLZ}/t_{PHZ}$	$V_{CC}=2.0V, C_L=50pF$		47	150	ns
		$V_{CC}=4.5V, C_L=50pF$		23	30	ns
		$V_{CC}=6.0V, C_L=50pF$		21	26	ns
Pulse Width	$t_w$	$V_{CC}=2.0V$	80			ns
		$V_{CC}=4.5V$	16			ns
		$V_{CC}=6.0V$	14			ns
Setup Time	$t_{SU}$	$V_{CC}=2.0V$	50			ns
		$V_{CC}=4.5V$	10			ns
		$V_{CC}=6.0V$	9			ns
Hold Time	$t_H$	$V_{CC}=2.0V$	20			ns
		$V_{CC}=4.5V$	5			ns
		$V_{CC}=6.0V$	5			ns

■ OPERATING CHARACTERISTICS ( $T_A=25^\circ C$ , unless otherwise specified)

PARAMETER	SYMBOL	TEST CONDITIONS	MIN	TYP	MAX	UNIT
Power Dissipation Capacitance	$C_{PD}$	No load		50		pF

## ■ TEST CIRCUIT AND WAVEFORMS

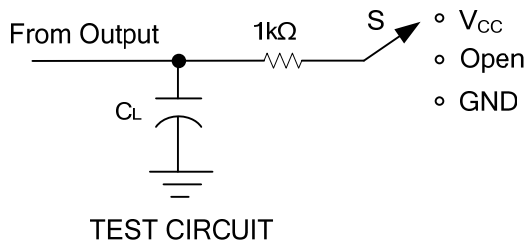

TEST	S
$t_{PLH}/t_{PHL}$	Open
$t_{PHZ}/t_{PZH}$	GND
$t_{PLZ}/t_{PZL}$	$V_{CC}$

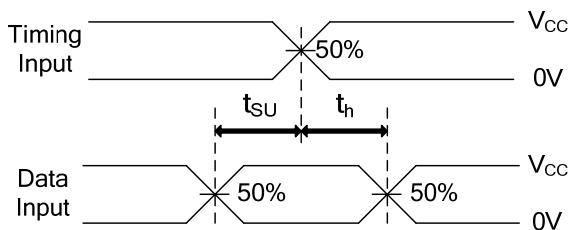

**SETUP TIME AND HOLD TIME**

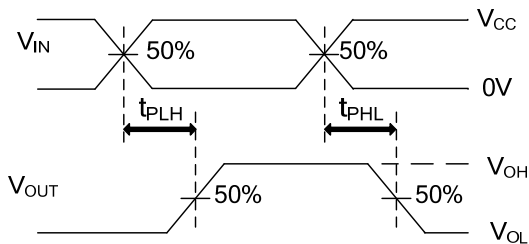

**PROPAGATION DELAY TIMES**

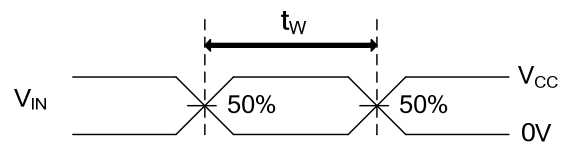

**PULSE WIDTH**

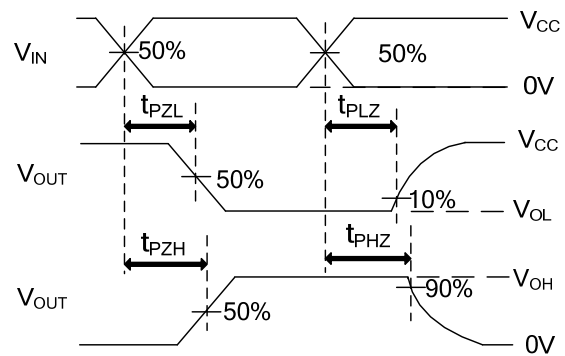

**ENABLE AND DISABLE TIMES**

Note:  $C_L$  includes probe and jig capacitance.  
 $PRR \leq 1\text{MHz}$ ,  $Z_o = 50\Omega$ ,  $t_R \leq 6\text{ns}$ ,  $t_F \leq 6\text{ns}$

UTC assumes no responsibility for equipment failures that result from using products at values that exceed, even momentarily, rated values (such as maximum ratings, operating condition ranges, or other parameters) listed in products specifications of any and all UTC products described or contained herein. UTC products are not designed for use in life support appliances, devices or systems where malfunction of these products can be reasonably expected to result in personal injury. Reproduction in whole or in part is prohibited without the prior written consent of the copyright owner. The information presented in this document does not form part of any quotation or contract, is believed to be accurate and reliable and may be changed without notice.