	<h1>Final Datasheet V1.0</h1>	TS 1378 Rev. 2 Page 1 of 13
	TPM Sensor SP30T	



Final Datasheet V1.0

Tire Pressure Monitoring Sensor SP30T

Revisions dates:

00	2007-06-11
1	2007-12-20
2	2008-05-29

Document history: See end of document

	Date	Sign	Rev	Reference	Date	Dok	Stamp
Prepared	070611	ML	0	Archive 11843	070813	HKW	
Checked	070613	NPH	1	EM 11866	080616	HKW	
Approved	070716	RH	2	EM 12044	080616		



	<h1>Final Datasheet V1.0</h1>	TS 1378 Rev. 2 Page 2 of 13
	TPM Sensor SP30T	

Table of Contents

1	PRODUCT DESCRIPTION	4
1.1	Overview.....	4
1.2	Features	4
1.3	Ordering Information	4
2	PRODUCT CHARACTERISTICS	5
2.1	Measurement Performance.....	5
2.1.1	<i>Pressure Measurement</i>	5
2.1.2	<i>Acceleration Measurement</i>	6
2.1.3	<i>Temperature Measurement</i>	6
2.1.4	<i>Supply Voltage Measurement</i>	6
2.2	Current Consumption	7
2.3	Tmax.....	7
2.4	Vmin	7
2.5	Clock Sources	8
2.5.1	<i>System Clock (MCLK)</i>	8
2.5.2	<i>Low Power (LP) Oscillator</i>	8
2.5.3	<i>External Clock</i>	8
2.6	LF Input	8
2.7	Power-on Reset.....	9
2.8	Digital I/O.....	9
3	OPERATING RANGE	9
4	ABSOLUTE MAXIMUM RATINGS	10
5	PHYSICAL DIMENSIONS	11
6	PIN CONFIGURATION	12
7	DOCUMENT HISTORY	13

	<h1>Final Datasheet V1.0</h1>	TS 1378 Rev. 2 Page 3 of 13
	TPM Sensor SP30T	

Edition 2008-05-29
Published by Infineon Technologies AG,
Am Campeon 1-12
85579 Neubiberg, Germany
© Infineon Technologies AG 2006-03-20.
All Rights Reserved.
Attention please!

The information herein is given to describe certain components and shall not be considered as a guarantee of characteristics.

Terms of delivery and rights to technical change reserved.

We hereby disclaim any and all warranties, including but not limited to warranties of non-infringement, regarding circuits, descriptions and charts stated herein.

Information

For further information on technology, delivery terms and conditions and prices please contact your nearest Infineon Technologies Office in Germany or the Infineon Technologies Companies and our Infineon Technologies Representatives worldwide (www.infineon.com).

Warnings

Due to technical requirements components may contain dangerous substances. For information on the types in question please contact your nearest Infineon Technologies Office.

Infineon Technologies Components may only be used in life-support devices or systems with the express written approval of Infineon Technologies, if a failure of such components can reasonably be expected to cause the failure of that life-support device or system, or to affect the safety or effectiveness of that device or system. Life support devices or systems are intended to be implanted in the human body, or to support and/or maintain and sustain and/or protect human life. If they fail, it is reasonable to assume that the health of the user or other persons may be endangered.

	Final Datasheet V1.0	TS 1378 Rev. 2 Page 4 of 13
	TPM Sensor SP30T	

1 Product Description

1.1 Overview

The SP30T Tire Pressure Monitoring (TPM) Sensor represents Infineon’s high pressure range TPM sensor for SUV and Truck application. The SP30T combines a high pressure range with a high level of integration by including a microcontroller and LF-input stage to meet market demands for flexible, customer specific solutions and overall system cost reduction.

The sensor design is based upon Infineon’s proprietary and patented solutions for high reliability measurements in harsh automotive environments, with a predictable and stable quality in high volume applications.

The SP30T measures pressures up to 1600kPa, temperature, supply voltage and acceleration (optional), and by integrating these functions with an ASIC in one package, Infineon has developed the ideal product for high pressure TPM applications.

1.2 Features

- Integrated Sensors
 - High pressure range
 - Acceleration
 - Temperature
 - Voltage
- Integrated Peripherals
 - Microcontroller
 - On board EEPROM
 - GPIOs
 - ADC for signal conditioning
 - 2x LF Receiver for triggering
- Measurement Ranges
 - Pressure Sensor 100 to 1600 kPa
 - Temperature Sensor -40 to +125°C
 - Supply Voltage Sensor 2.1 to 3.6 V
 - Acceleration Sensor -12 to 115 g

1.3 Ordering Information

Product Name	Product Type	Ordering Code	Package
SP30T-00E00-06B	Tire Pressure Monitoring Sensor	SP000411794	P-DSOSP-14-6

2 Product Characteristics

The max and min numbers are to be understood as + and – 5σ values (Cpk = 1.67) unless otherwise specified.

2.1 Measurement Performance

2.1.1 Pressure Measurement

The presented performance reflects the use of 11-bit measurement of pressure signal and 10-bit measurement of temperature.

Table 1 Pressure measurement specifications

PARAMETER	SPECIFICATION				AMBIENT CONDITIONS			COMMENTS
	Min	Typ	Max	Unit	Temp [°C]	VDD [V]	Pressure [kPa]	
Input pressure range*	100		1600	kPa	-40 to 125	2.1 to 3.6		
Measurement error	-25		25	kPa	0 to 50	2.1 to 3.6	100 to 1000	Linear behavior between 1000 kPa and 1600 kPa according to Figure 1
	-30		30	kPa	-40 to 125	2.1 to 3.6		
	-45		45	kPa	0 to 50	2.1 to 3.6	1000 to 1600	
	-50		50	kPa	-40 to 125	2.1 to 3.6		

Table 2 Pressures 100, 375, 657, 1000, 1300, 1600 kPa verified in qualification

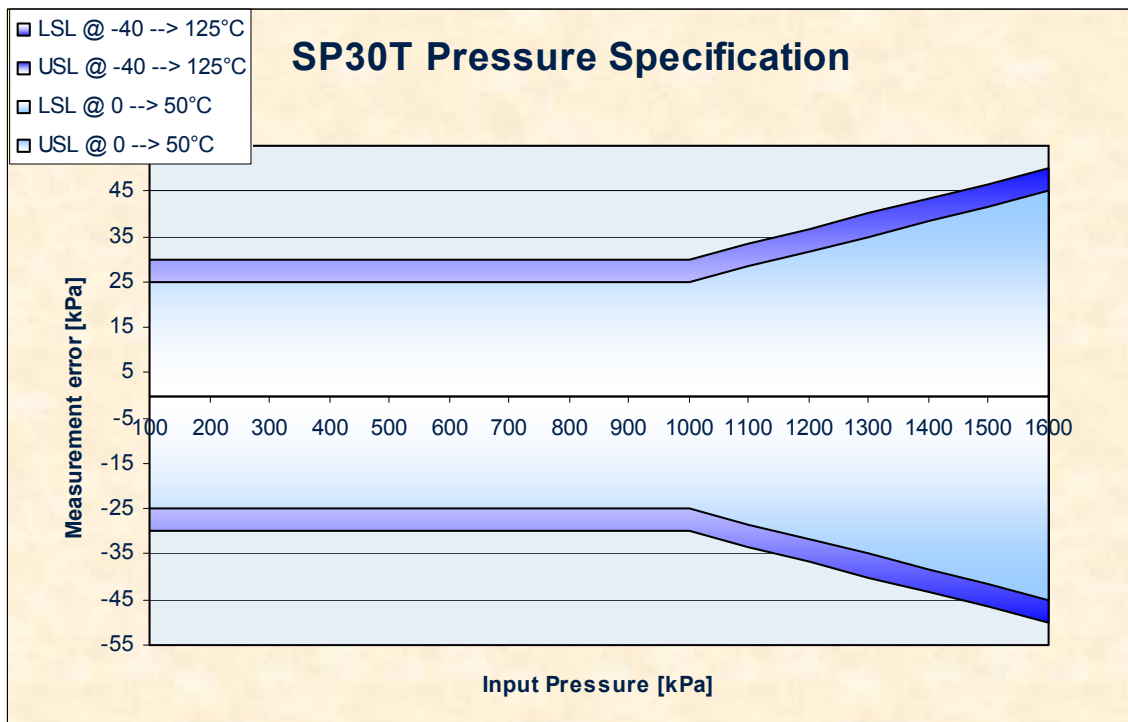



Figure 1: Pressure measurement error

	Final Datasheet V1.0					TS	1378
	TPM Sensor SP30T					Rev.	2
						Page	6
						of	13

2.1.2 Acceleration Measurement

The presented performance reflects the use of 12-bit measurement of acceleration signal and 10-bit measurement for temperature.

Table 2 Acceleration measurement specifications

PARAMETER	SPECIFICATION				AMBIENT CONDITIONS		COMMENTS
	Min	Typ	Max	Unit	Temp [°C]	VDD [V]	
Input acceleration range	-12		115	g	-40 to 125	2.1 to 3.6	
Sensitivity error	-18.75		18.75	%	-40 to 90	2.1 to 3.6	
	-24		24		90 to 125		
Offset error@9g	-6		6	g	-20 to 70	2.1 to 3.6	
	-8.5		8.5		-40 to 90		
	-12		12		90 to 125		

2.1.3 Temperature Measurement

The presented performance reflects the use of 10-bit measurement of temperature.

Table 3 Temperature measurement specifications

PARAMETER	SPECIFICATION				AMBIENT CONDITIONS		COMMENTS
	Min	Typ	Max	Unit	Temp [°C]	VDD [V]	
Measurement error	-3		3	°C	-20 to 70	2.1 to 3.6	
	-5		5	°C	-40 to 90	2.1 to 3.6	
	-3		7	°C	90 to 125	2.1 to 3.6	

2.1.4 Supply Voltage Measurement

The presented performance reflects the use of 9-bit measurement of supply voltage.

Table 4 Supply voltage measurement specifications

PARAMETER	SPECIFICATION				AMBIENT CONDITIONS		COMMENTS
	Min	Typ	Max	Unit	TEMP [°C]	VDD [V]	
Measurement error	-100		+100	mV	-40 to 125	V _{THR} to 3.6	

	Final Datasheet V1.0					TS	1378
	TPM Sensor SP30T					Rev.	2
						Page	7
						of	13

2.2 Current Consumption

Table 5 Current consumption

PARAMETER	SPECIFICATION				AMBIENT CONDITIONS		COMMENTS
	Min	Typ	Max	Unit	Temp [°C]	VDD [V]	
Power down current		0.4	0.6	µA	25	3.0	
Power down current		13	20	µA	125	3.0	
IDLE current		30	50	µA	25	3.0	
IDLE current		50	75	µA	125	3.0	
RUN current		0.53	0.8	mA	25	3.0	
RUN current		0.65	1.0	mA	125	3.0	
Pressure measurement		4	12	µAs	-40 to 125	2.1 to 3.6	11 bit A/D conversion, excl. temperature meas
Acceleration measurement		6	16	µAs	-40 to 125	2.1 to 3.6	12 bit A/D conversion, excl. temperature meas
Temperature measurement		0.9	2.5	µAs	-40 to 125	2.1 to 3.6	10 bit A/D conversion
Supply voltage measurement		0.3	2.5	µAs	-40 to 125	2.1 to 3.6	9 bit A/D conversion
Peak current		1.6	2.5	mA	25	3.0	Pressure measurement and 1 LF channel on, duration is 1280µs for 11 bit measurement for the peak current only.
1 channel LF current		2.6	4.6	µA	25	3.0	
1 channel LF current		3.0	6.7	µA	125	3.0	
2 channel LF current		4.5	5.5	µA	25	3.0	2 nd LF channel is optional
2 channel LF current		6.5	11	µA	125	3.0	2 nd LF channel is optional
Thermal shutdown current		18	25	µA	125	3.0	
Thermal shutdown current		30	50	µA	150	3.0	

2.3 Tmax

ϑ_{SHTD} represents the temperature at which the Thermal Shut-down function can be enabled and ϑ_{REL} represents the temperature at which the Master Reset state is released. The ϑ_{SHTD} is always higher than ϑ_{REL} .

Table 6 Trigger temperatures for thermal shutdown

PARAMETER	SPECIFICATION				AMBIENT CONDITIONS		COMMENTS
	Min	Typ	Max	Unit	TEMP [°C]	VDD [V]	
ϑ_{SHTD}	102		123	°C	-40 to 175	2.1 to 3.6	Thermal shutdown enable
ϑ_{REL}	100		121	°C	-40 to 175	2.1 to 3.6	Master Reset release

2.4 Vmin

The voltage at which the Vmin-circuit will return a low battery voltage status is specified in Table :

Table 7 Vmin specifications

PARAMETER	SPECIFICATION				AMBIENT CONDITIONS		COMMENTS
	Min	Typ	Max	Unit	TEMP [°C]	VDD [V]	
Vmin	2.0	2.1	2.2	V	-40 to 125	V _{THR} to 3.6	

	Final Datasheet V1.0					TS	1378
	TPM Sensor SP30T					Rev.	2
						Page	8
						of	13

2.5 Clock Sources

2.5.1 System Clock (MCLK)

Table 8 System clock (MCLK) specifications

PARAMETER	SPECIFICATION				AMBIENT CONDITIONS		COMMENTS
	Min	Typ	Max	Unit	TEMP [°C]	VDD [V]	
MCLK frequency	1.8	2.0	2.2	MHz	-40 to 125	2.1 3.6	

2.5.2 Low Power (LP) Oscillator

Table 9 LP oscillator specifications

PARAMETER	SPECIFICATION				AMBIENT CONDITIONS		COMMENTS
	Min	Typ	Max	Unit	TEMP [°C]	VDD [V]	
T _{it}	0.5, 1.0, 2.0 or 4.0			s	-40 to 125	2.1 to 3.6	Interval timer main tick
del _{2t}	25, 50, 75 or 100			ms	-40 to 125	2.1 to 3.6	Delay to extra tick
LP oscillator accuracy	-20		20	%	-40 to 125	2.1 to 3.6	

2.5.3 External Clock

Table 10 External clock specifications

PARAMETER	SPECIFICATION				AMBIENT CONDITIONS		COMMENTS
	Min	Typ	Max	Unit	TEMP [°C]	VDD [V]	
External clock			3.5	MHz	-40 to 125	2.1 to 3.6	

2.6 LF Input

Table 11 LF telegram

PARAMETER	SPECIFICATION				AMBIENT CONDITIONS		COMMENTS
	Min	Typ	Max	Unit	TEMP [°C]	VDD [V]	
Modulation		ASK			-40 to 125	2.1 to 3.6	
Carrier frequency	121.25	125	128.75	kHz	-40 to 125	2.1 to 3.6	
Preamble period	4			ms	-40 to 125	2.1 to 3.6	
Data rate	3.84	3.9	3.96	kHz	-40 to 125	2.1 to 3.6	
Settling time			2	ms	-40 to 125	2.1 to 3.6	Time from LF interface is turned on by RISC to the LF interface is active
Detection threshold			5	mVp-p	-40 to 125	2.1 to 3.6	
Input capacitance		10	12	pF	-40 to 125	2.1 to 3.6	
Input resistance	500			kΩ	-40 to 125	2.1 to 3.6	
Other	The input signals from the enabled LF channels are rectified and real time summed						

	Final Datasheet V1.0					TS	1378
	TPM Sensor SP30T					Rev.	2
						Page	9
						of	13

Table 12 LF Carrier Detection

PARAMETER	SPECIFICATION				AMBIENT CONDITIONS		COMMENTS
	Min	Typ	Max	Unit	TEMP [°C]	VDD [V]	
Carrier frequency	121.25	125	128.75	kHz	-40 to 125	2.1 to 3.6	
Maximum sensitivity not to detect, 2 amplifiers enabled	4			mVp-p	0 to 90	2.1 to 3.6	
	3.5			mVp-p	90 to 125	2.1 to 3.6	
	3.5			mVp-p	-40 to 0	2.1 to 3.0	
	2.9			mVp-p	-40 to 0	3.0 to 3.6	
Minimum sensitivity to detect, 2 amplifiers enabled	10			mVp-p	0 to 90	2.1 to 3.6	
	12.2			mVp-p	90 to 125	2.1 to 3.6	
	12.2			mVp-p	-40 to 0	2.1 to 3.6	
Maximum sensitivity not to detect, 3 amplifiers enabled		0.8		mVp-p	-40	3.6	
	0.25			mVp-p	-40	2.1 to 3.0	
	0.25			mVp-p	0 to 125	2.1 to 3.6	
Minimum sensitivity to detect, 3 amplifiers enabled			2.5	mVp-p	-40 to 125	2.1 to 3.6	

2.7 Power-on Reset

Table 13 Power-on reset level

PARAMETER	SPECIFICATION				COMMENTS
	Min	Typ	Max	Unit	
Power-on reset level, V_{THR}	1.8	1.85	1.9	V	

2.8 Digital I/O

Table 14 Digital I/O specifications

PARAMETER	SPECIFICATION				COMMENTS
	Min	Typ	Max	Unit	
Digital output high	$V_{DD}-0.3$			V	At 1 mA load current
Digital output low			0.3	V	At 1 mA load current
Digital input high	$0.8 \cdot V_{DD}$			V	
Digital input low			$0.2 \cdot V_{DD}$	V	
Input current			± 1	μA	

3 Operating Range

Table 15 Operating range

PARAMETER	SPECIFICATION				COMMENTS
	Min	Typ	Max	Unit	
Supply voltage	V_{THR}		3.6	V	Unless otherwise specified
Ambient temperature	-40		125	°C	

	Final Datasheet V1.0				TS	1378
	TPM Sensor SP30T				Rev.	2
					Page	10
					of	13

4 Absolute Maximum Ratings

Table 16 Absolute maximum ratings

PARAMETER	SPECIFICATION				COMMENTS
	Min	Typ	Max	Unit	
Ambient temperature, operating	-40		150	°C	Max 24 h accumulated over life time
Ambient temperature, storage	-40		150	°C	Max 1000 h
Transient temperature ¹			175	°C	Max 3 min
Supply Voltage	-0.3		4.0	V	
Input voltage	-0.3		V _{dd} +0.3	V	
Input current, any pin (DC)	-10		10	mA	
Input current, any pin (transient)	-100		100	mA	
Input current, LF pins	-1		1	mA	
Maximum input pressure	50		2000	kPa	Max 2 s, 5 times over lifetime
			2500	kPa	
Static acceleration			3000	g	
Mechanical shock			4000	g	Half sine, 0.3ms
ESD HBM	2			kV	Human body model JESD22-A114
ESD CDM	750			V	Charge Device Model ESD-STM5.3.1, Corner pins
	500				Charge Device Model ESD-STM5.3.1, All other pins
Latch Up	100			mA	AEC-Q100

¹ Will withstand standard SnPb Eutectic reflow soldering process (JEDEC J-STD-020, J-STD-A113)

Attention: *Stresses above the max. values listed here may cause permanent damage to the device. Exposure to absolute maximum rating conditions for extended periods may affect device reliability. Maximum ratings are absolute ratings; exceeding only one of these values may cause irreversible damage to the device.*

5 Physical dimensions

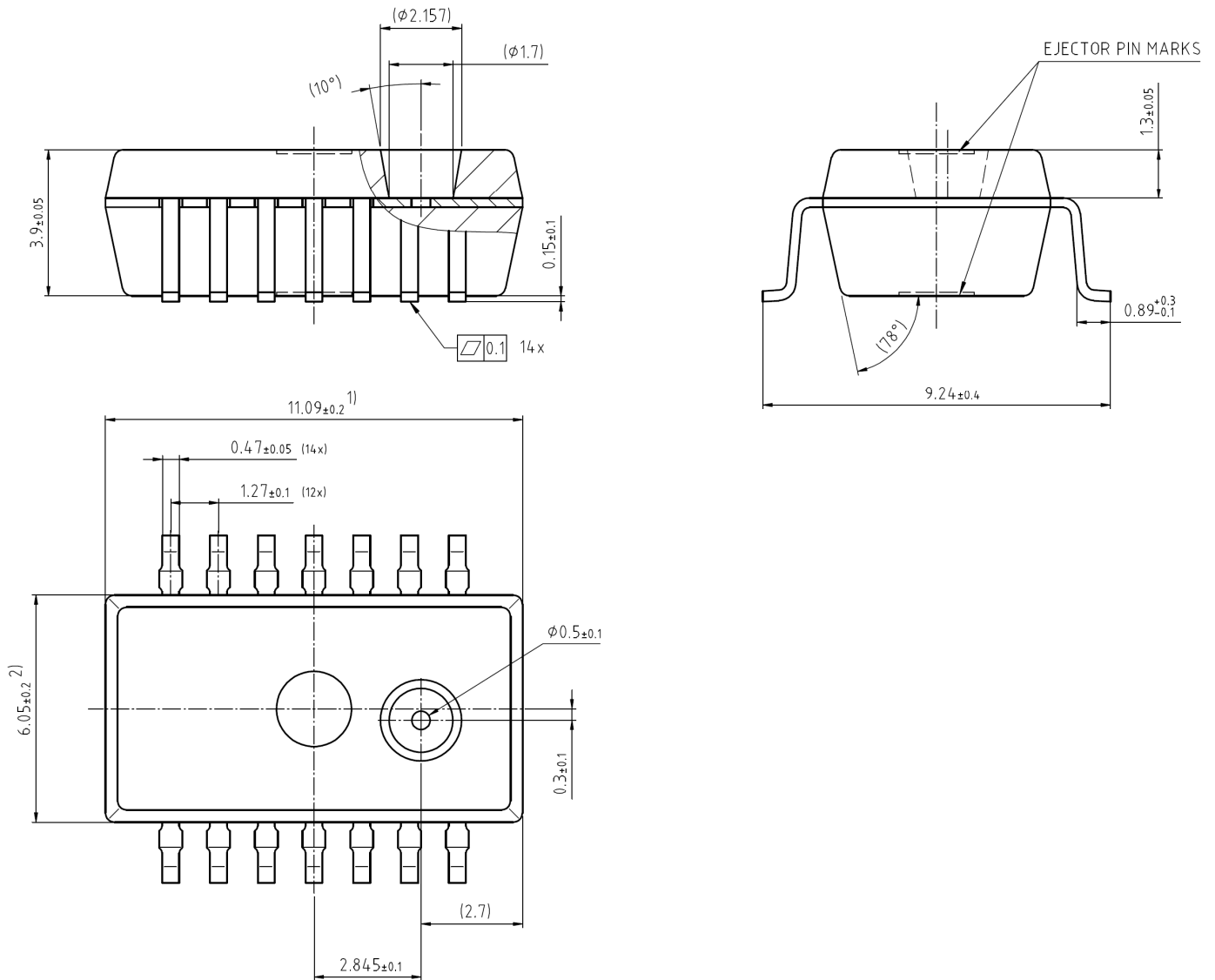

Figure 2: Physical Dimensions – Drawing P-DSOSP-14-6 1) Dimension does not include mold flash, protrusions or gate burrs. Mold flash, protrusions and gate burrs do not exceed 0.15mm (0.006 inch) per side. 2) Dimension does not include inter-lead flash or protrusions. Inter-lead flash and protrusions do not exceed 0.25mm (0.010 inch) per side.

6 Pin Configuration

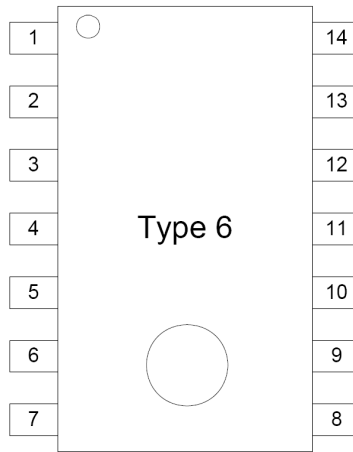



Figure 3: Pin Configuration. Top view, not to scale

Table 17 Pin Description

PIN	NAME	FUNCTION
1	IN4	LF receiver channel 2, negative input
2	P10	General purpose I/O with external wakeup, internal pull-up/pull-down
3	P11	General purpose I/O with external wakeup, internal pull-up/pull-down
4	MSDA	Monitor Serial Data I/O, internal pull-up
5	MSCL	Monitor Serial Clock input
6	VDD	Supply pad VDD (battery, positive terminal)
7	VSS	Common ground (battery, negative terminal)
8	VSS	Common ground (battery, negative terminal)
9	P17	General purpose I/O (or digital modulator output)
10	P15	General purpose I/O or external clock
11	P14	General purpose I/O (or digital modulator output)
12	IN1	LF receiver channel 1, positive input
13	IN2	LF receiver channel 1, negative input
14	IN3	LF receiver channel 2, positive input

	<h1>Final Datasheet V1.0</h1>	TS 1378 Rev. 2
	TPM Sensor SP30T	Page 13 of 13

7 Document history

Rev	Paragraphs	Description
00		First issue of TS1378
1	1	Disclaimer included
1	2.1.1	Pressure range extended from max 1500kPa to max 1600kPa. Measurement error adjusted accordingly.
1	2.1.1	Footnote included displaying the Pressure values verified in qualification
1	5	Physical Drawing updated
2	1	Added section "Product Description "
2	5	Physical Drawing updated
2	5	Added wording to Figure title of figure 2
2	6	Added section "Pin Configuration"
2		Removed "Confidential" marking
2	2	Updated fig. 1