

Features

- ✧ High efficiency, low VF
- ✧ High current capability
- ✧ High reliability
- ✧ High surge current capability
- ✧ Low power loss
- ✧ For use in low voltage, high frequency inverter, Free wheeling, and polarity protection application
- ✧ Green compound with suffix "G" on packing code & prefix "G" on datecode

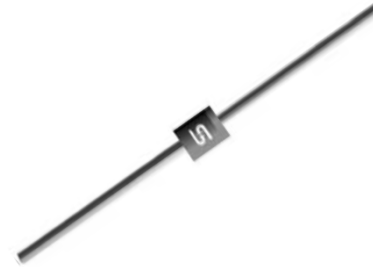

Mechanical Data

- ✧ Cases: Molded plastic
- ✧ Epoxy: UL 94V-0 rate flame retardant
- ✧ Lead: Pure tin plated, lead free, solderable per MIL-STD-202, Method 208 guaranteed
- ✧ Polarity: Color band denotes cathode
- ✧ High temperature soldering guaranteed: 260°C/10 seconds/.375", (9.5mm) lead lengths at 5 lbs., (2.3kg) tension
- ✧ Weight: 1.2 grams

Ordering Information (example)

Part No.	Package	Packing	INNER TAPE	Packing code	Green Compound Packing code
SF31	DO-201AD	500 / AMMO box	52mm	A0	A0G

Maximum Ratings and Electrical Characteristics

Rating at 25 °C ambient temperature unless otherwise specified.

Single phase, half wave, 60 Hz, resistive or inductive load.

For capacitive load, derate current by 20%

Type Number	Symbol	SF 31	SF 32	SF 33	SF 34	SF 35	SF 36	SF 37	SF 38	Units
Maximum Recurrent Peak Reverse Voltage	V_{RRM}	50	100	150	200	300	400	500	600	V
Maximum RMS Voltage	V_{RMS}	35	70	105	140	210	280	350	420	V
Maximum DC Blocking Voltage	V_{DC}	50	100	150	200	300	400	500	600	V
Maximum Average Forward Rectified Current	$I_{F(AV)}$	3								A
Peak Forward Surge Current, 8.3 ms Single Half Sine-wave Superimposed on Rated Load (JEDEC method)	I_{FSM}	125								A
Maximum Instantaneous Forward Voltage (Note 1) @ 3 A	V_F	0.95			1.3		1.7			V
Maximum DC Reverse Current at Rated DC Blocking Voltage @ $T_A=25\text{ }^\circ\text{C}$	I_R	5								uA
		100								uA
Maximum Reverse Recovery Time (Note 2)	T_{rr}	35								nS
Typical Junction Capacitance (Note 3)	C_j	80				70				pF
Typical Thermal Resistance	$R_{\theta JA}$	35								$^\circ\text{C/W}$
Operating Temperature Range	T_J	- 65 to + 125								$^\circ\text{C}$
Storage Temperature Range	T_{STG}	- 65 to + 150								$^\circ\text{C}$

Note 1: Pulse Test with PW=300 usec, 1% Duty Cycle

Note 2: Reverse Recovery Test Conditions: $I_F=0.5A$, $I_R=1.0A$, $I_{RR}=0.25A$

Note 3: Measured at 1 MHz and Applied Reverse Voltage of 4.0V D.C.

RATINGS AND CHARACTERISTIC CURVES (SF31 THRU SF38)

FIG.1- MAXIMUM AVERAGE FORWARD CURRENT DERATING

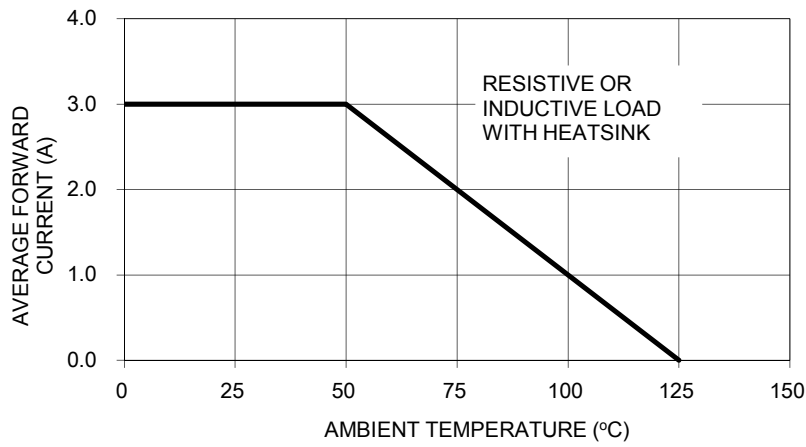

FIG.2- TYPICAL REVERSE CHARACTERISTICS

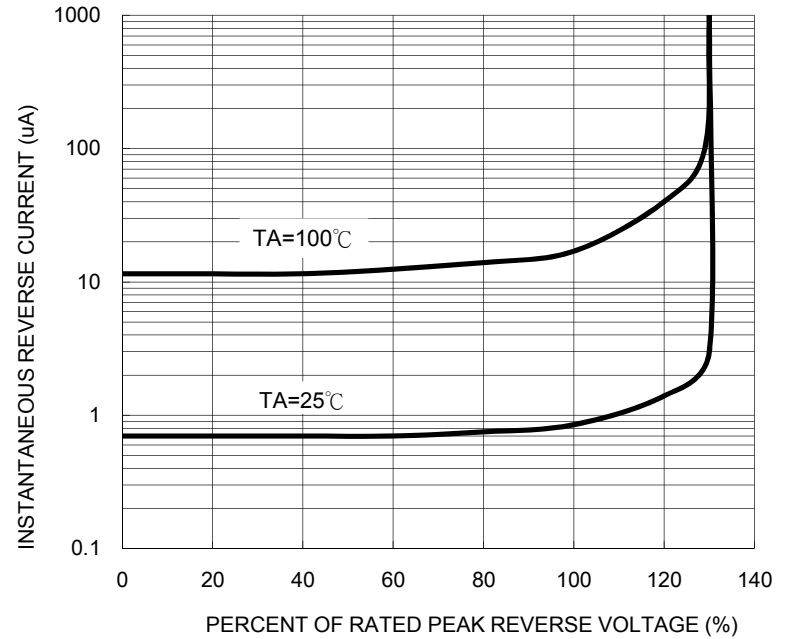

FIG. 3- MAXIMUM NON-REPETITIVE FORWARD SURGE CURRENT

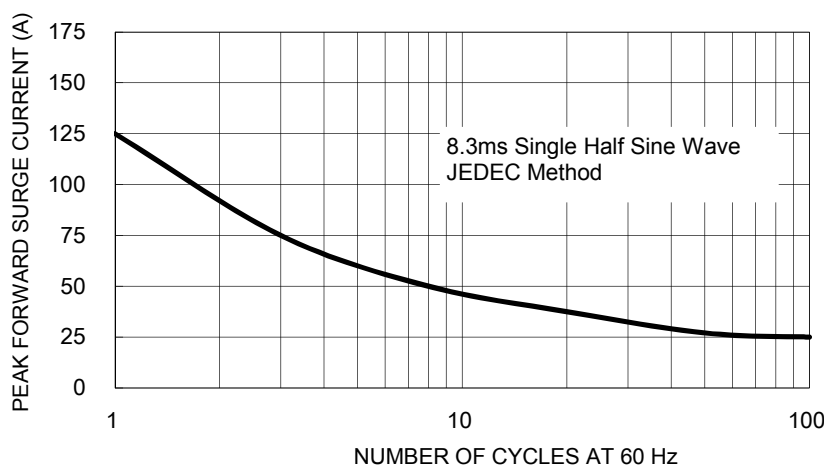

FIG. 5- TYPICAL FORWARD CHARACTERISTICS

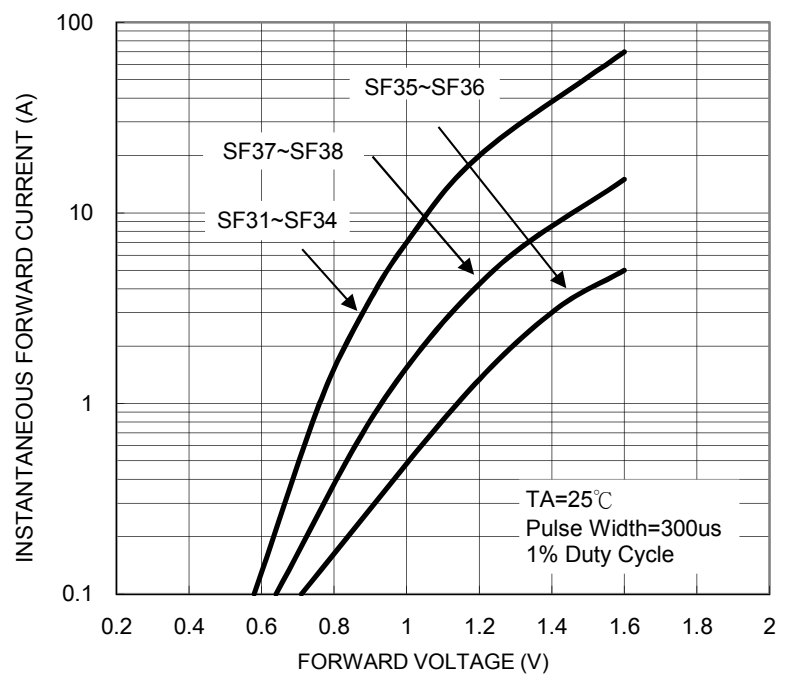

FIG. 4- TYPICAL JUNCTION CAPACITANCE

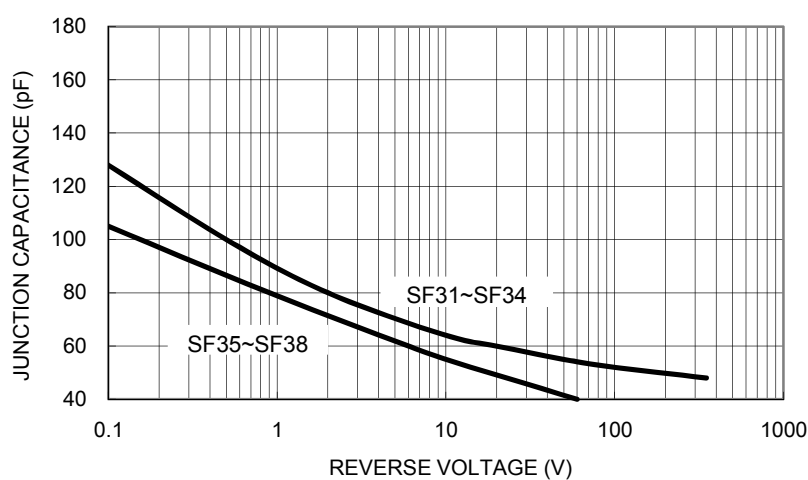
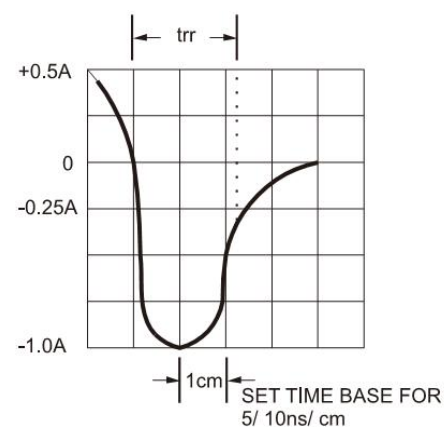
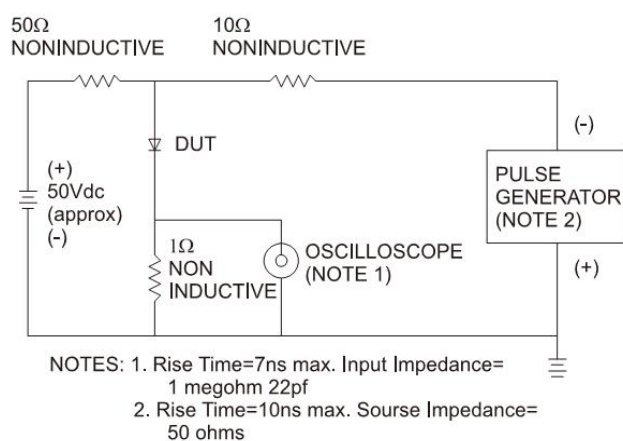

FIG.6- REVERSE RECOVERY TIME CHARACTERISTIC AND TEST CIRCUIT DIAGRAM



Ordering information

Part No.	Package	Packing	INNER TAPE	Packing code	Green Compound Packing code
SF3x (Note)	DO-201AD	500 / AMMO box	52mm	A0	A0G
	DO-201AD	1.25K / 13" Reel	52mm	R0	R0G
	DO-201AD	500 / Bulk packing		B0	B0G
	DO-201AD	500 / Bulk packing		X0	X0G

Note: "x" is Device Code from "1" thru "8".

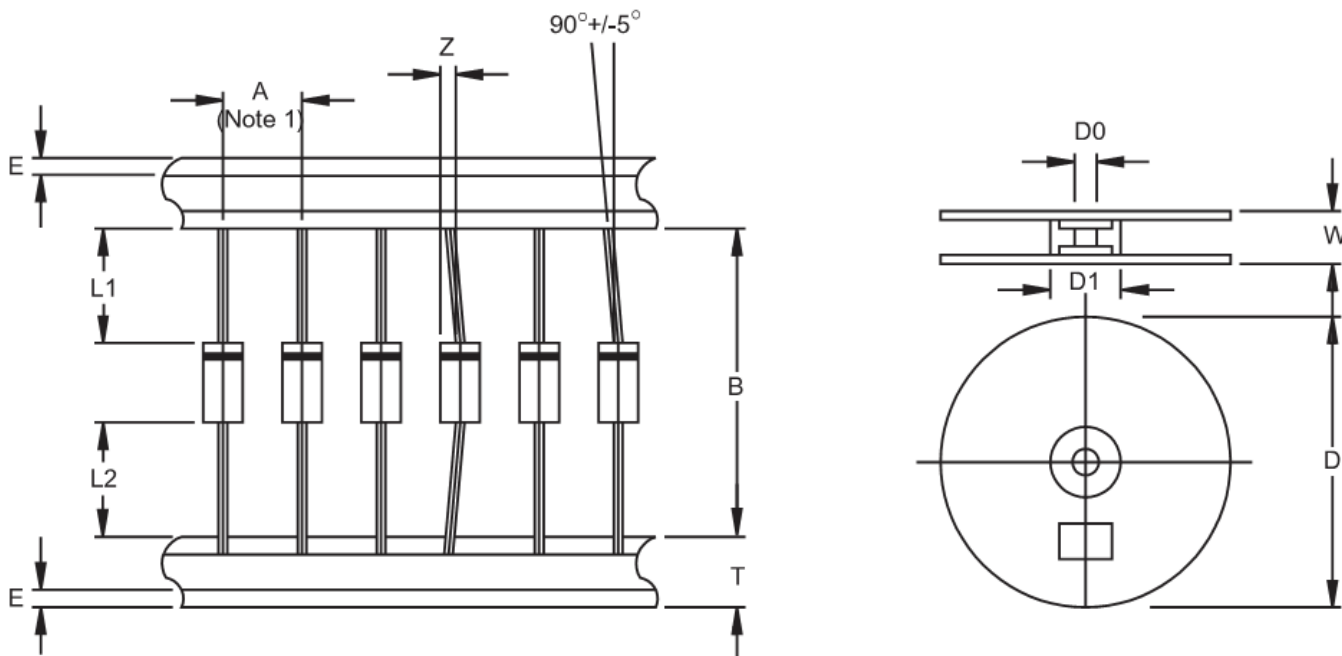
AXIAL LEAD TAPING SPECIFICATIONS

Outline	A	B	Z	T	E	L1-L2	D	D1	D0	W
		±0.5	±1.5	MAX	±0.4	MAX	MAX		±0.3	±0.4
DO-201AD	10	52.4	1.2	6	0.8	1	330	85.7	16.6	76

Unit (mm)

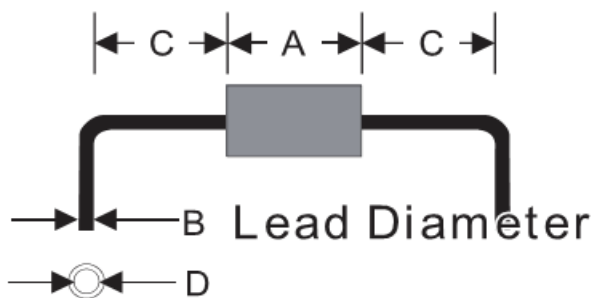
Suggested Mounting Hole Rule

Symbol	Unit(mm)
A	9.0
B	1.2
C	4.0
D	1.6

Dimensions

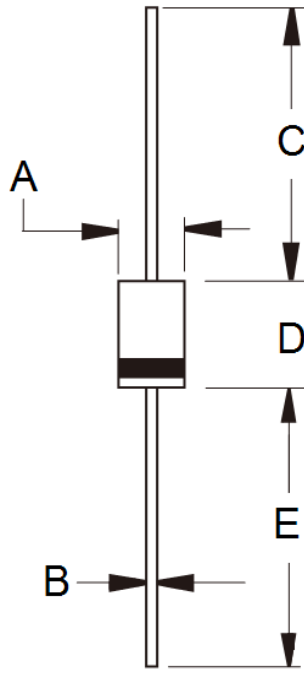

DIM.	Unit(mm)		Unit(inch)	
	Min	Max	Min	Max
A	5.00	5.60	0.197	0.220
B	1.20	1.30	0.048	0.052
C	25.40	-	1.000	-
D	8.50	9.50	0.335	0.375
E	25.40	-	1.000	-

Marking Diagram



- P/N = Specific Device Code
- G = Green Compound
- YWW = Date Code