

## FLOPPY DISK FORMATTER/CONTROLLER (FDC)

### DESCRIPTION

The Fujitsu MB8876A and MB8877A are one-chip Floppy Disk Formatter/Controllers (FDC) which are fabricated with N-channel E/D MOS technology. They can be applied to any single density floppy disk, double density floppy disk and mini floppy disk.

The IBM3740 format and the frequency modulation (FM) recording are used for the single density

storage, and the IBM System-34 format and the modified frequency modulation (MFM) recording are used for the double density storage.

The MB8867A and MB8877A interface with an 8-bit parallel microprocessor to control data transfer and mechanical operation. They are packaged in a standard 40-pin dual in-line package.

### FEATURES

- Interface to 8-bit Microprocessor
  - MB8876A: Negative-logic 8-bit Data Bus
  - MB8877A: Positive-logic 8-bit Data Bus
- IBM Compatible Sector Format
- Automatic Track Seeking and Verification
- Both Single and Double Density Formats
  - a) Single Density in IBM3740 Format and FM Recording
  - b) Double Density in IBM System-34 Format and MFM Recording
- Programmable Single Sector/ Multiple Sectors/Entire Track Read Operation
- Programmable Single Sector/ Multiple Sectors/Entire Track Write Operation
- Programmable Side Compare Function
- Programmable Sector Length
- Programmable Head Step Rate
- Applicable to Single Density, Double Density, and Mini Floppy Disks
- Programmable Head Engage/Head Settle Time
- Double Buffered Data I/O
- DMA Data Transfer Capability
- Write Precompensation Capability
- All TTL Compatible I/O
- Single + 5V Power Supply
- N-Channel Silicon-gate E/D MOS Process
- MB8876A: Upward Compatible with Western Digital FD1791-02
- MB8877A: Upward Compatible with Western Digital FD1793-02
- Two Package Options
  - 40-pin Ceramic DIP (Suffix: -C)
  - 40-pin Plastic DIP (Suffix: -P)

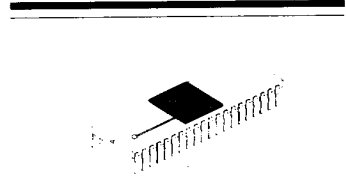

CERAMIC DIP  
DIP-40C-A01

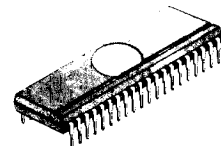

PLASTIC DIP  
DIP-40P-M01

### PIN ASSIGNMENT

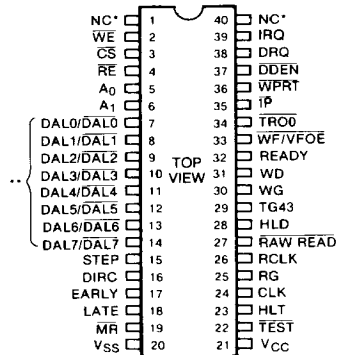

PACKAGE  
DIP-40C-A01

\* No Connection

\*\* MB8876A: Negative Logic

MB8877A: Positive Logic

This device contains circuitry to protect the inputs against damage due to high static voltages or electric fields. However, it is advised that normal precautions be taken to avoid application of any voltage higher than maximum rated voltages to this high impedance circuit.

FUJITSU reserves the right to change products and specifications without notice. This information does not convey any license under patent rights of FUJITSU LTD. or others.

**MB8876A/MB8877A****PIN DESCRIPTIONS**

Pin No.	Symbol	Pin Name	I/O	Description
20	V <sub>SS</sub>	Power Supply	I	Ground (GND)
21	V <sub>CC</sub>			+5V DC supply
24	CLK	Clock	I	2-MHz fixed frequency clock signal (1-MHz for mini-floppy disk).
19	$\overline{MR}$	Master Reset	I	Signal for resetting the FDC.
22	TEST	Test	I	Signal for setting the FDC into a test mode.
1, 40	NC	Non Connection	—	These pins are not used.

**MPU INTERFACE PINS**

37	$\overline{DDEN}$	Double Density	I	Signal for selecting a FDC operation mode: When $\overline{DDEN} = 0$ , the double density operation mode is selected. When $\overline{DDEN} = 1$ , the single density operation mode is selected. This input must be fixed while the FDC is in busy state.
3	$\overline{CS}$	Chip Select	I	Signal for controlling the DALs: When $\overline{CS} = 0$ , the DALs are activated and data transfer between the FDC and the MPU is enabled. When $\overline{CS} = 1$ , the DALs are in high impedance state and data transfer is inhibited. (i.e., RE and WE are ignored.)
4	$\overline{RE}$	Read Enable	I	Strobe signal provided when data is read from internal registers: When $\overline{CS} = \overline{RE} = 0$ , data can be read from internal registers.
2	$\overline{WE}$	Write Enable	I	Strobe signal provided when data is written into internal registers: When $\overline{CS} = \overline{WE} = 0$ , data can be written internal registers.
5, 6	A <sub>0</sub> , A <sub>1</sub>	Register Select Line	I	Signal for addressing an internal register among Command Register (CR), Status Register (STR), Track Register (TR), Sector Register (SCR) and Data Register (DR): Refer to table of REGISTER SELECTION (p. 6).
7 ~ 14	DAL <sub>0</sub> ~ DAL <sub>7</sub> DAL <sub>0</sub> ~ DAL <sub>7</sub>	Data Access Line	I/O	8-bit bidirectional bus for transferring 8-bit data between the FDC and the MPU. MB8876A: negative logic/MB8877A: positive logic.
38	DRQ	Data Request	O	Signal for informing the MPU of a DR status: Read operation: DRQ = 1 shows the DR is filled with a 8-bit data from a disk, and the FDC is requesting for the MPU to read the data. Write operation: DRQ = 1 shows the DR is empty, and the FDC is requesting for the MPU to write the next data into the DR.
39	IRQ	Interrupt Request	O	Interrupt signal to the MPU: IRQ is set when a Command is completed or the TYPE IV Command is executed. IRQ is reset when the next Command is written or the STR is read.

**FLOPPY DISK INTERFACE PINS****Disk Head Control Signal**

15	STEP	Step Move	O	Step pulse signal for moving a disk head.
16	DIRC	Direction	O	Signal for indicating a direction of disk head moving to the FDD: DIRC = 0 shows the head moves toward outside. DIRC = 1 shows the head moves toward inside.
28	HLD	Head Load	O	Signal for loading a disk head: When HLD = 1, the head is engaged on the disk. When HLD = 0, the head is released from the disk.

**FUJITSU  
MICROELECTRONICS**

## Disk Head Control Signal (Continued)

Pin No.	Symbol	Pin Name	I/O	Description
23	HLT	Head Load Timing	I	Signal for informing a disk head status: HLT = 1 shows a disk head is in an engaged state. HLT is set when a disk head has been settled or a head settle time pre-determined by one shot circuit has elapsed after HLD = 1.
34	TR00	Track 00	I	Signal for informing whether a disk head is positioned on Track No. 00 or not: TR00 = 0 shows Track No. 00 is detected during track seeking operation.
32	READY	Ready	I	Signal for informing the FDC of a disk drive status: READY = 1 shows the disk drive is ready for operation, and only when READY = 1, read/write operation for disk can be executed. READY = 0 shows the disk drive is not ready, and neither read/write operation cannot be executed. However, seek operation is executed regardless of this signal.
35	IP	Index Pulse	I	Signal for informing the FDC of an index hole of disk being detected in the FDD.

## Disk Read Operation Signal

25	RG	Read Gate	O	Signal for informing synchronization between RCLK and RAWREAD to an external VFO circuit: RG = 1 show the FDC has found out a SYNC byte during disk reading operation.
26	RCLK	Read Clock	I	A data window signal which is generated in an external VFO circuit out of Read Data.
27	RAWREAD	Raw Read	I	A raw read data signal transferred from the FDD.

## Disk Write Operation Signal

30	WG	Write Gate	O	Signal for indicating data is being written into a disk.
17	EARLY	Early Shift	O	Signal for indicating early pre-compensation of data write timing to a disk: EARLY = 1 shows a serial data to be transmitted via the WD pin to a disk must be shifted earlier.
18	LATE	Late Shift	O	Signal for indicating later pre-compensation of data write timing to a disk: LATE = 1 shows a serial data to be transmitted via the WD pin to a disk must be shifted later.
31	WD	Write Data	O	A write data signal transferred to the FDD.
29	TG43	Track Greater Than 43	O	Signal for indicating a head position of a disk: TG43 = 1 shows the head is located on any Track No. 44 thru 76. TG43 = 0 shows the head is located on any Track No. 0 thru 43.
33	WF/VFOE	Write Fault/Variable Frequency Oscillator Enable	I/O	Input signal for informing a fault is detected during write operation for a disk (during WG = 1). Output signal for informing the FDC is reading a disk (during WG = 0).
34	WPRT	Write Protect	I	Signal for inhibiting write operation for disk.

# MB8876A/MB8877A

## REGISTER SELECTION

Chip Select	Address		Selected Register		Data Access Line Status
$\overline{CS}$	$A_1$	$A_0$	Read Mode ( $\overline{RE} = 0$ )	Write Mode ( $\overline{WE} = 0$ )	$\overline{DAL}_7 \sim \overline{DAL}_0$ $\overline{DAL}_7 \sim \overline{DAL}_0$
1	*	*	Deselected	Deselected	High Impedance
0	0	0	Status Register (STR)	Command Register (CR)	Enabled
0	0	1	Track Register (TR)	Track Register (TR)	Enabled
0	1	0	Sector Register (SCR)	Sector Register (SCR)	Enabled
0	1	1	Data Register (DR)	Data Register (DR)	Enabled

\*: Don't care

## MB8876A/MB8877A BLOCK DIAGRAM

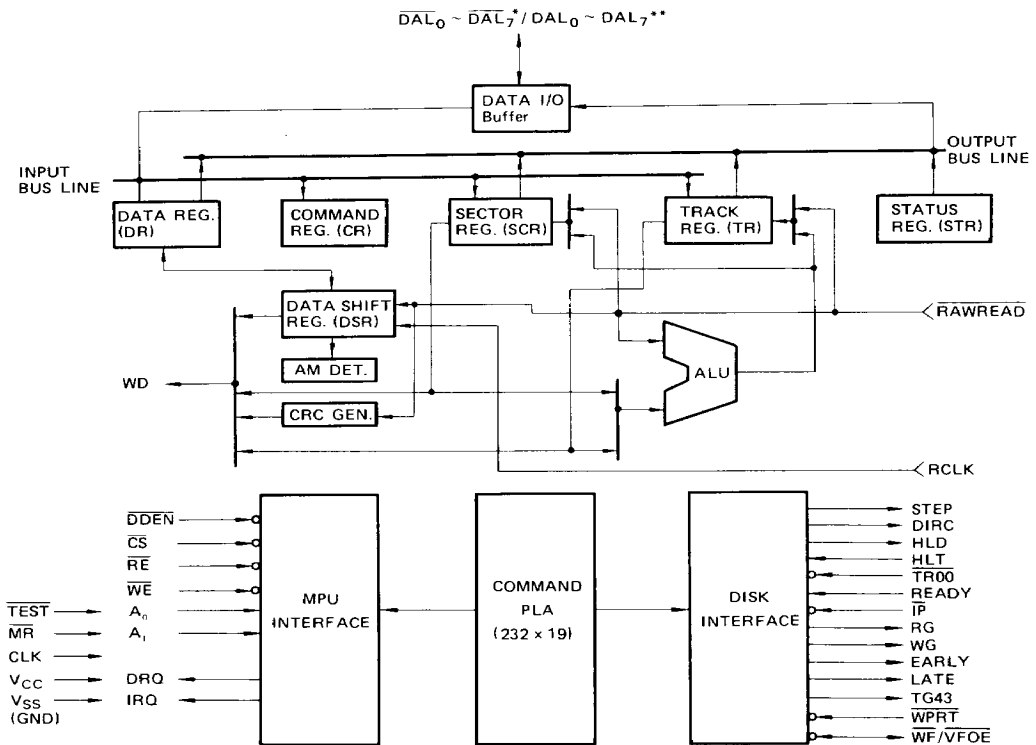

\* MB 8876A: Negative Logic  
 \*\* MB 8877A: Positive Logic

**FUJITSU**  
**MICROELECTRONICS**

## FUNCTIONAL BLOCK DESCRIPTION

### INTERNAL REGISTERS

- **Command Register (CR)**

An 8-bit write-only register, holds the command which is being executed. This register should not be loaded when the BUSY flag is set (BUSY = 1) unless the execution of the current command is to be overridden, using the Force Interrupt command.

- **Status Register (STR)**

An 8-bit read-only register, holds the device status information. The contents of STR are automatically updated according to the status of the executing Command. After the STR is read, the IRQ output is usually reset (IRQ = 0) except for the Type IV Command.

- **Data Register (DR)**

An 8-bit read/write used as a holding register during Disk Read and Write operations. In Disk Read operations, the serial data assembled in the Data Shift Register is transferred to the DR, where it is made available to the data bus. In Disk Write operations, parallel data from the data bus is written into the DR where it is transferred to Data Shift Register. In a Seek Command, the data written into the DR holds the address of the desired Track address.

- **Data Shift Register (DSR)**

An 8-bit shift register which cannot be accessed directly through the data bus. The DSR assembles serial data from the RAW READ input during Read operations and transfers the data to the DR. In Write operations, the DSR receives data from the DR and serially transfers it out through the WRITE DATA output.

- **Track Register (TR)**

An 8-bit read/write register, holds the track number of the current disk head position for Restore, Seek, Step, Step-In and Step-Out Commands (i.e. TYPE 1 Commands), and is updated during the Command execution. The TR contents are compared with the track number (recorded in the disk's ID field) during

ing Read, Write, and Verify operations. The TR should not be written to when the device is busy (BUSY = 1).

- **Sector Register (SCR)**

An 8-bit read/write register, holds the address of the desired sector number. The sector number is written into the SCR prior to the Read and Write Data Command execution. It should not be written to during busy (BUSY = 1). Executing the Read Address Command causes the SCR to be loaded with the track number from the ID field.

### OTHER FUNCTIONAL BLOCKS

- **Cycle Redundancy Check (CRC) Logic**

This logic is used for checking or generating the 16-bit Cycle Redundancy Check that is in the ID and Data fields used for error detection. The polynomial is:  $G(X) = X^{16} + X^{12} + X^5 + 1$ .

- **Arithmetic/Logic Unit (ALU)**

The ALU is a serial comparator, incrementer, and decremter used for register comparisons and modifications with the disk record ID fields.

- **Address Mark (AM) Detection Circuit**

A circuit to detect specific bit pattern data in the serial data from a disk (i.e. Index Mark, ID Address Mark, Data Address Mark).

- **Data Modulator**

A circuit to modulate data to be written onto a disk in the specific recording format: Single density recording format: Frequency Modulation (FM) Double density recording format: Modified Frequency Modulation (MFM)

- **Programmable Logic Array (PLA) for Commands**

A micro-program to generate control signals (Commands) which control the FDC operation: The size of micro-program is approximately 232 x 19 bits.

**MB8876A/MB8877A**

**BIT STRUCTURES OF COMMANDS**

**MB8876A/MB8877A**

TYPE	COMMAND	BITS							
		7	6	5	4	3	2	1	0
I	Restore	0	0	0	0	h	V	r <sub>1</sub>	r <sub>0</sub>
I	Seek	0	0	0	1	h	V	r <sub>1</sub>	r <sub>0</sub>
I	Step	0	0	1	u	h	V	r <sub>1</sub>	r <sub>0</sub>
I	Step In	0	1	0	u	h	V	r <sub>1</sub>	r <sub>0</sub>
I	Step Out	0	1	1	u	h	V	r <sub>1</sub>	r <sub>0</sub>
II	Read Sector	1	0	0	m	S	E	C	0
II	Write Sector	1	0	1	m	S	E	C	a <sub>0</sub>
III	Read Address	1	1	0	0	0	E	0	0
III	Read Track	1	1	1	0	0	E	0	0
III	Write Track	1	1	1	1	0	E	0	0
IV	Force Interrupt	1	1	0	1	l <sub>3</sub>	l <sub>2</sub>	l <sub>1</sub>	l <sub>0</sub>

NOTE: Bits shown in TRUE form.

**TABLE 1. STEPPING RATES**

CLK	2 MHz	2 MHz	1 MHz	1 MHz	2 MHz	1 MHz
DDEN	0	1	0	1	X	X
R1 R0	TEST = 1	TEST = 1	TEST = 1	TEST = 1	TEST = 0	TEST = 0
0 0	3 ms	3 ms	6 ms	6 ms	184μs	368μs
0 1	6 ms	6 ms	12 ms	12 ms	190μs	380μs
1 0	10 ms	10 ms	20 ms	20 ms	198μs	396μs
1 1	15 ms	15 ms	30 ms	30 ms	208μs	416μs

**TYPE I COMMANDS**

**h = Head Load Flag (Bit 3)**  
 h = 1, Load head at beginning  
 h = 0, Unload head at beginning

**V = Verify flag (Bit 2)**  
 V = 1, Verify on destination track  
 V = 0, No verify

**r<sub>1</sub> r<sub>0</sub> = Stepping motor rate (Bits 1-0)**  
 Refer to Table 1 for rate summary

**u = Update flag (Bit 4)**  
 u = 1, Update Track register  
 u = 0, No update

**TYPE II & III COMMANDS**

**m = Multiple Record flag (Bit 4)**  
 m = 0, Single Record  
 m = 1, Multiple Records

**a<sub>0</sub> f = Data Address Mark (Bit 0)**  
 a<sub>0</sub> = 0, FB (Data Mark)  
 a<sub>0</sub> = 1, F8 (Deleted Data Mark)

**E = 15 ms Delay (2MHz)**  
 E = 1, 15 ms delay  
 E = 0, no 15 ms delay

**S = Side Select Flag**  
 S = 0, Compare for Side 0  
 S = 1, Compare for Side 1

**C = Side Compare Flag**  
 C = 0, disable side select compare  
 C = 1, enable side select compare

**TYPE IV COMMAND**

**li = Interrupt Condition flags (Bits 3-0)**  
 l<sub>0</sub> = 1, Not-Ready to Ready Transition  
 l<sub>1</sub> = 1, Ready to No-Ready Transition  
 l<sub>2</sub> = 1, Index Pulse  
 l<sub>3</sub> = 1, Immediate Interrupt  
 l<sub>3</sub> - l<sub>0</sub> = 0, Terminate with no Interrupt

## STATUS REGISTER SUMMARY

Command	Status Bit							
	7	6	5	4	3	2	1	0
All Type I	Not Ready	Write Protect	Head Loaded	Seek Error	CRC Error	Track 0	Index	Busy
Read Sector	Not Ready	0	Record Type	Rec not Found	CRC Error	Lost Data	DRQ	Busy
Write Sector	Not Ready	Write Protect	Write Fault	Rec not Found	CRC Error	Lost Data	DRQ	Busy
Read Address	Not Ready	0	0	Rec not Found	CRC Error	Lost Data	DRQ	Busy
Read Track	Not Ready	0	0	0	0	Lost Data	DRQ	Busy
Write Track	Not Ready	Write Protect	Write Fault	0	0	Lost Data	DRQ	Busy

## STATUS DESCRIPTION FOR TYPE I COMMANDS

Bit	Name	Meaning
S7	Not Ready	This bit when set indicates the drive is not ready. When reset it indicates that the drive is ready. This bit is an inverted copy of the Ready input and logically 'ored' with MR.
S6	Protected	When set, indicates Write Protect is activated. This bit is an inverted copy of WRPT input.
S5	Head Loaded	When set, it indicates the head is loaded and engaged. This bit is a logical "and" of HLD and HLT signals.
S4	Seek Error	When set, the desired track was not verified. This bit is reset to 0 when updated.
S3	CRC Error	CRC encountered in ID filed.
S2	Track 00	When set, indicates Read/Write head is positioned to Track 0. This bit is an inverted copy of the TR00 input.
S1	Index	When set, indicates index mark detected from drive. This bit is an inverted copy of the IP input.
S0	Busy	When set command is in progress. When reset no command is in progress.

## STATUS DESCRIPTION FOR TYPE II AND III COMMANDS

Bit	Name	Meaning
S7	Not Ready	This bit when set indicates the drive is not ready. When reset, it indicates that the drive is ready. This bit is an inverted copy of the Ready input and 'ored' with MR. The Type II and III Commands will not execute unless the drive is ready.
S6	Write Protect	On Read Record: Not Used. On Read Track: Not Used. On any Write: It indicates a Write Protect. This bit is reset when updated.
S5	Record Type/ Write Fault	On Read Record: It indicates the record-type code from data field address mark. 1 = Deleted Data Mark. 0 = Data Mark. On any Write: It indicates a Write Fault. This bit is reset when updated.
S4	Record Not Found (RNF)	When set, it indicates that the desired track, sector, or side were not found. This bit is reset when updated.
S3	CRC Error	If S4 is set, an error is found in one or more ID fields; otherwise it indicates error in data field. This bit is reset when updated.
S2	Lost Data	When set, it indicates the computer did not respond to DRQ in one byte time. This bit is reset to zero when updated.
S1	Data Request	This bit is a copy of the DRQ output. When set, it indicates the DR is full on a Read Operation or the DR is empty on a Write operation. This bit is reset to zero when updated.
S0	Busy	When set, command is under execution. When reset, no command is under execution.

TRACK FORMAT

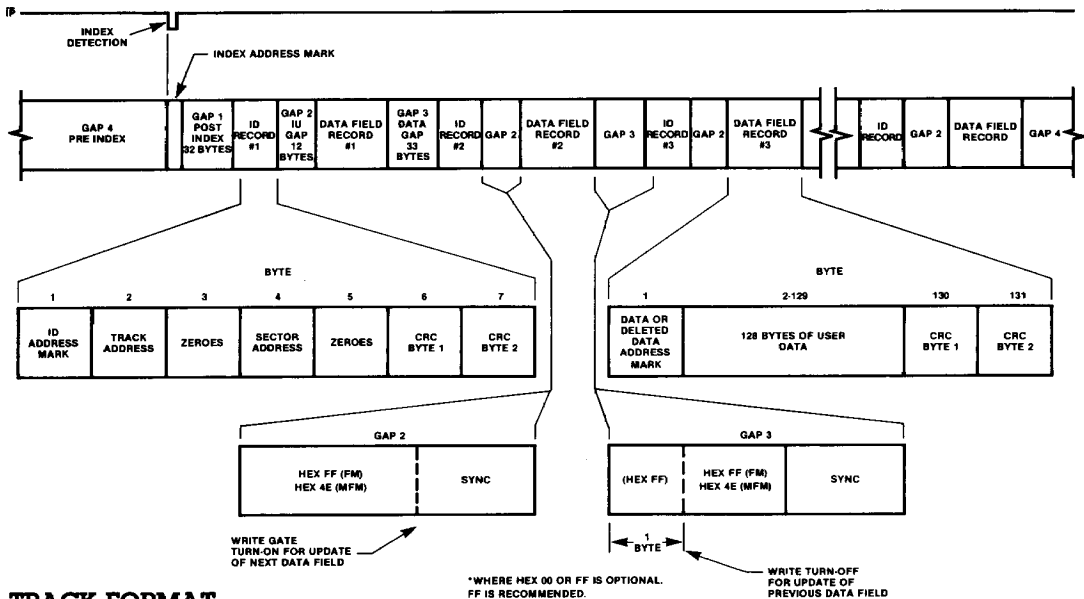

TRACK FORMAT

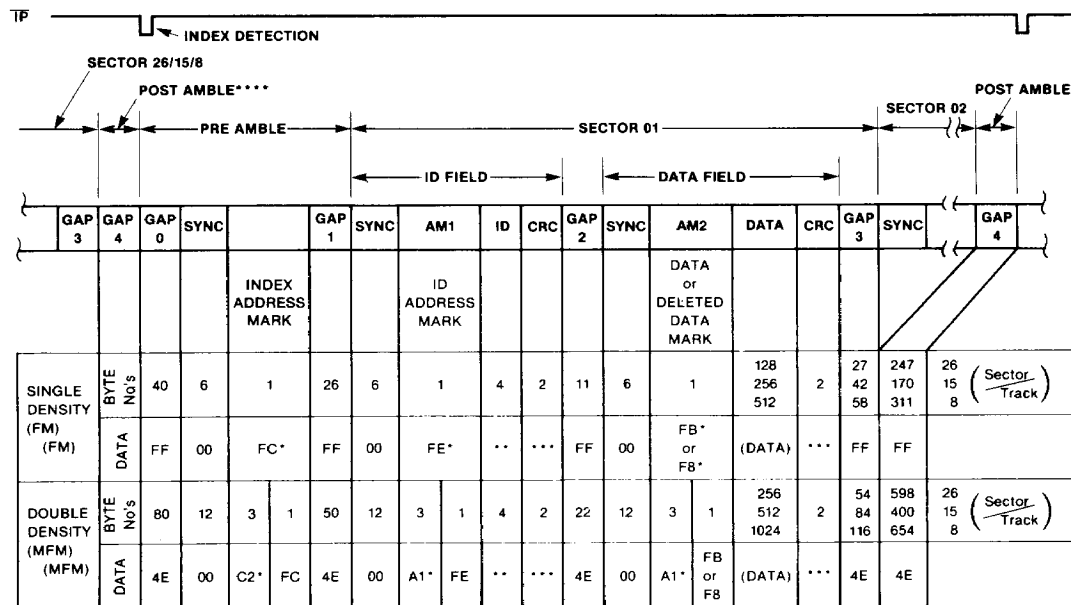

NOTE: \*: Shows to have missing clock.  
 \*\*: Shows the ID field  
 \*\*\*: Shows the cyclic Redundancy check polynomial  $G(X) = X^5 + X^{12} + X^{16}$   
 \*\*\*\*: See the most right column for its byte numbers and data.



SECTOR FORMAT

ID FIELD									DATA FIELD						
SYC	ID AM	TRACK NUMBER	SIDE NUMBER	SECTOR NUMBER	SECTOR LENGTH	CRC 1	CRC 2	GAP 2	SYNC	DATA AM	DATA	CRC 1	CRC 2	GAP 3	
6	1	1	1	1	1	1	1	11	6	1	*	1	1	27/42/58	
bytes	byte	byte	byte	byte	byte	byte	byte	bytes	bytes	byte	*	byte	byte	bytes	
12	4	1	1	1	1	1	1	22	12	4	*	1	1	54/84/116	
bytes	bytes	byte	byte	byte	byte	byte	byte	bytes	bytes	byte	*	byte	byte	bytes	

(FM)  
or  
(MFM)

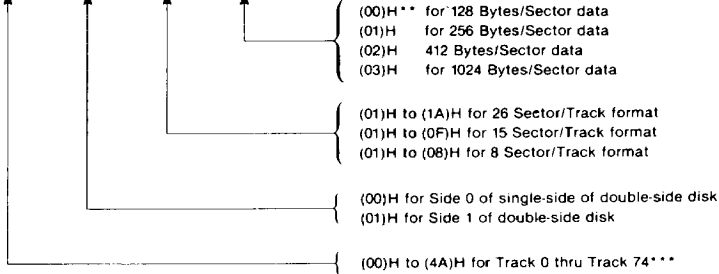

NOTE \*\*: Byte number of this column is defined in the SECTOR LENGTH column.  
 \*\*\*: "H" after parentheses show that the parenthesized figures are hexa-decimal.  
 \*\*\*: Track 75 and 76 are usually used for correction.

MB8876A/MB8877A TYPICAL SYSTEM CONSTRUCTION

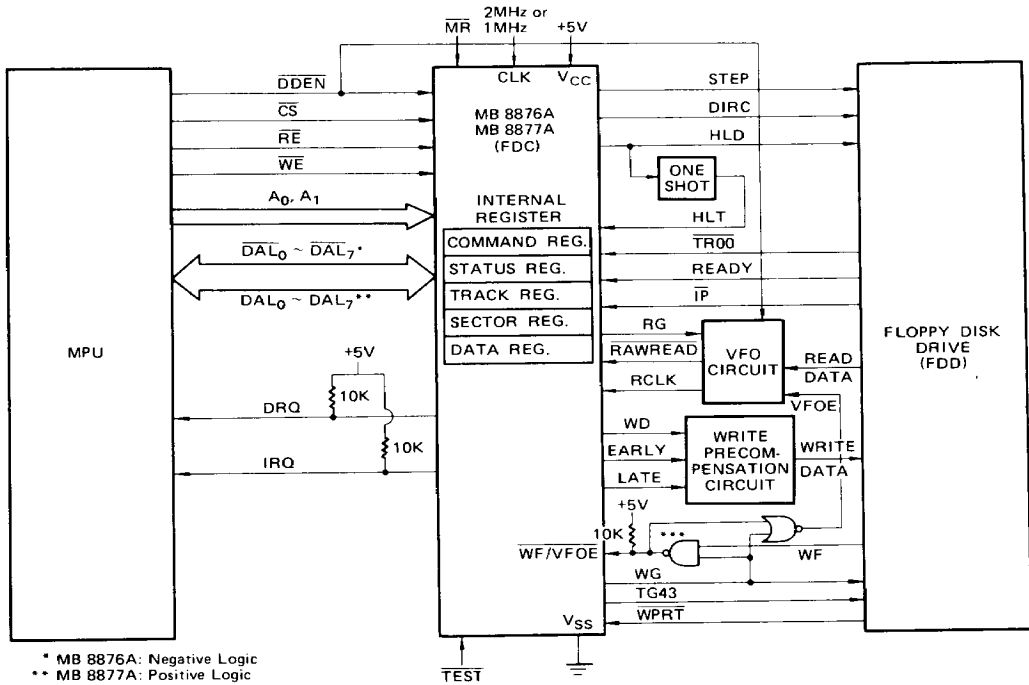

\* MB 8876A: Negative Logic  
 \*\* MB 8877A: Positive Logic  
 \*\*\* Open Collector Output

## MB8876A/MB8877A

### IBM 3740 Format

This single-density (FM) format utilizes 128 bytes/sector. The bytes to be generated by the system MPU for use in the execution of the Write Track command are shown below.

Data Byte (hex)	No. of Bytes	Comments
FF	40	Gap 5 (Post Index)
00	6	
FC	1	Index AM
FF	26	Gap 1
00	6	
FE	1	ID AM
XX	1	Track Number (00-4A)
0X	1	Side Number (00 or 01)
XX	1	Sector Number (01-1A)
00	1	Sector Length (128 bytes)
F7	1	Causes 2-Byte CRC to be Written
FF	11	Gap 2 (ID Gap)
00	6	
FB	1	Data AM
E5	128	Data Field
F7	1	Causes 2-Byte CRC to be Written
FF	27	Part of Gap 3 (Data Gap)
FF	247 <sup>②</sup>	Gap 4 (Pre-Index)

ONE SECTOR  
①

- Notes:** 1. This pattern must be written 26 times per track.  
2. Continue writing Hex FF until FDC completes sequence and generates INTRQ interrupt.

### IBM System 34 Format

This double-density (MFM) format utilizes 256 bytes/sector. The bytes to be generated by the system MPU for use in the execution of the Write Track command are shown below.

Data Byte (hex)	No. of Bytes	Comments
4E	80	Gap 5 (Post Index)
00	12	
F6	3	Writes C2
FC	1	Index AM
4E	50	Gap 1
00	12	
F5	3	Writes ID AM Sync Bytes
FE	1	ID AM
XX	1	Track Number (00-4C)
0X	1	Side Number (00 or 01)
XX	1	Sector Number (01-1A)
01	1	Sector Length (256 Bytes)
F7	1	Causes 2-Byte CRC to be Written
4E	22	Gap 2 (ID Gap)
00	12	
F5	3	Writes ID AM Sync Bytes
FB	1	Data AM
40	256	Data Field
F7	1	Causes 2-Byte CRC to be Written
4E	54	Part of Gap 3 (Data Gap)
4E	598 <sup>②</sup>	Gap 4 (Pre Index)

ONE SECTOR  
①

- Notes:** 1. This pattern must be written 26 times per track.  
2. Continue writing Hex 4E until FDC completes sequence and generates INTRQ interrupt.

**ABSOLUTE MAXIMUM RATINGS**

Parameter	Symbol	Rating	Unit
Voltage on any pin	$V_{CC}, V_{IN}, V_{OUT}$	$V_{SS} - 0.3$ to $V_{SS} + 7.0$	V
Operating Temperature	$T_A$	0 to 70	°C
Storage Temperature	$T_{stg}$	-55 to +150	°C

Note: Permanent device damage may occur if Absolute Maximum Ratings are exceeded. Functional operation should be restricted to the conditions as detailed in the operational sections of this data sheet. Exposure to absolute maximum rating conditions for extended periods may affect device reliability.

**RECOMMENDED OPERATING CONDITIONS**

Parameter	Symbol	Value			Unit	Operating Temperature
		Min	Typ	Max		
Supply Voltage	$V_{CC}$	4.75	5.00	5.25	V	0°C to +70°C
	$V_{SS}$	—	0	—		
Input High Voltage	$V_{IH}$	2.0	—	$V_{CC}$	V	
Input Low Voltage	$V_{IL}$	-0.3	—	0.8	V	

**DC CHARACTERISTICS**

(Recommended Operating Conditions unless otherwise noted.)

Parameter	Symbol	Value			Unit
		Min	Typ	Max	
Output High Voltage ( $I_{OH} = -200\mu A$ )	$V_{OH}$	2.4	—	—	V
Output Low Voltage ( $I_{OL} = 1.8mA$ )	$V_{OL}$	—	—	0.4	V
Three-State (Off-State) Input Current ( $V_{IN} = 0.4V$ to 2.4)	$I_{TSI}$	—	—	10	$\mu A$
Input Leakage Current (See Note 1)	$I_{IN1}$	—	—	2.5	$\mu A$
Input Leakage Current (See Note 2)	$I_{IN2}$	—	—	100	$\mu A$
Output Leakage Current for Off-State ( $V_{OH} = 2.4V$ )	$I_{LOH}$	—	—	10	$\mu A$
Power Consumption	$P_D$	—	—	350	mW

Note1) Except for HLT, TEST, WF, WPRT, and DDEN. ( $V_{IN} = 0$  to 5.25V)  
 2) For HLT, TEST, WF, WPRT, and DDEN. ( $V_{IN} = 0$  to 5.25V)

4

# MB8876A/MB8877A

## AC CHARACTERISTICS

(Recommended Operating Conditions unless otherwise noted.)

### MPU Read Timing (From FDC)

Parameter	Symbol	Value			Unit
		Min	Typ	Max	
Address Setup Time	$t_{SET}$	50	—	—	ns
Address Hold Time	$t_{HLD}$	10	—	—	ns
$\overline{RE}$ Pulse Width	$t_{RE}$	280	—	—	ns
DRQ Reset Time	$t_{DRR}$	—	—	250	ns
IRQ Reset Time	$t_{IRR}$	—	—	500	ns
Data Delay Time ( $C_L = 25pF$ )	$t_{DACC}$	—	—	250	ns
Data Hold Time ( $C_L = 25pF$ )	$t_{DOH}$	50	—	150	ns
DRQ Service Time (RCLK Cycle = $2\mu s$ )	$t_{SEVR}$	—	—	13.5*	$\mu s$

\*: These values are doubled when CLK = 1MHz.

### READ TIMING

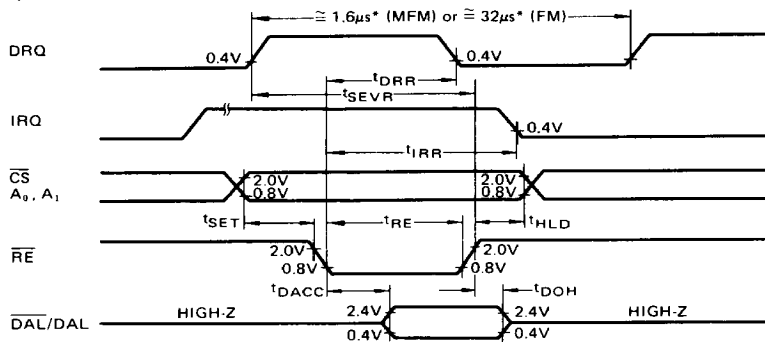

**FUJITSU**  
MICROELECTRONICS

**MPU Write Timing** (To FDC)

Parameter	Symbol	Value			Unit
		Min	Typ	Max	
Address Setup Time	$t_{SET}$	50	—	—	ns
Address Hold Time	$t_{HLD}$	10	—	—	ns
WE Pulse Width	$t_{WE}$	200	—	—	ns
DRQ Reset Time	$t_{DRR}$	—	—	250	ns
INTRQ Reset Time	$t_{IRR}$	—	—	500	ns
Data Setup Time	$t_{DS}$	250	—	—	ns
Data Hold Time	$t_{DH}$	0	—	—	ns
DRQ Service Time (DDEN = "L")	$t_{SEVW}$	—	—	11.5*	$\mu$ s

\*: These values are doubled when CLK = 1MHz.

**WRITE TIMING**

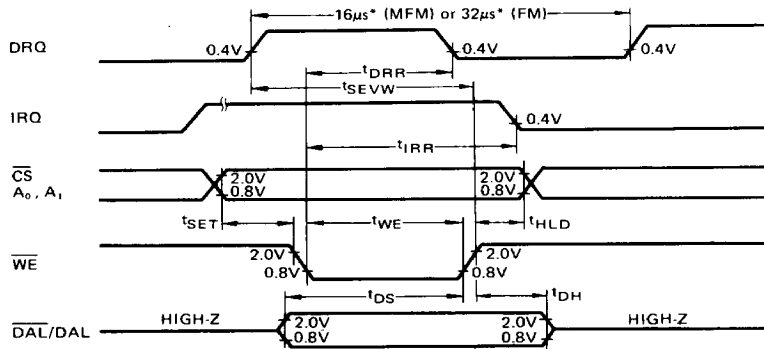

\*: These values are doubled when CLK = 1MHz.

# MB8876A/MB8877A

## FDC Read Data Timing (From Disk)

Parameter	Symbol	Value			Unit	
		Min	Typ	Max		
RAWREAD Pulse Width	$t_{pw}$	100	—	250*	ns	
Clock Setup Time	$t_D$	40	—	—	ns	
Clock Hold Time for MFM	$t_{CD}$	40	—	—	ns	
Clock Hold Time for FM	$t_{CS}$	40	—	—	ns	
RAWREAD Cycle Time	MFM	$t_{BC}$	—	2*, 3* or 4*	—	$\mu S$
	FM		—	2* or 4*	—	$\mu S$
RCLK High Pulse Width	MFM	$t_A$	0.8	1*	20	$\mu S$
	FM		0.8	2*	20	$\mu S$
RCLK Low Pulse Width	MFM	$t_B$	0.8	1*	20	$\mu S$
	FM		0.8	2*	20	$\mu S$
RCLK Cycle Time	MFM	$t_C$	—	2*	—	$\mu S$
	FM		—	4*	—	$\mu S$

\*: These values are double when CLK = 1MHz.

## READ DATA TIMING

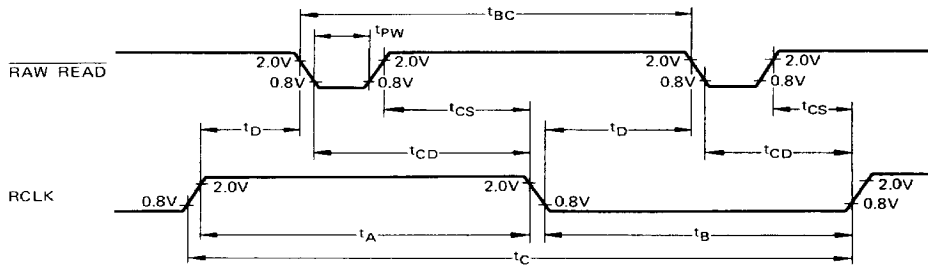

**FUJITSU**  
MICROELECTRONICS

**FDC Write Data Timing** (To Disk)

Parameter	Symbol	Conditions	Value			Unit	
			Min	Typ	Max		
Write Data Pulse Width	$t_{WD}^{**}$	CLK = 2 MHz	FM	450	500	550	ns
			MFM	150	200	250	
Write Gate To Write Data	$t_{WG}^{**}$	CLK = 2 MHz	FM	—	2	—	$\mu$ s
			MFM	—	1	—	
Write Gate off from WD	$t_{WF}^{**}$	CLK = 2 MHz	FM	—	2	—	$\mu$ s
			MFM	1	—	2	
Early (Late) to Write Data	$t_S$	CLK = 2 MHz	MFM	125	—	—	ns
Early (Late) from Write Data	$t_H$	CLK = 2 MHz	MFM	-50*	—	—	ns
WD Valid to CLK	$t_{D1}$	CLK = 1 MHz	MFM	200	—	—	ns
		CLK = 2 MHz	MFM	30	—	—	
WD Valid after CLK	$t_{D2}$	CLK = 1 MHz	MFM	50	—	—	ns
		CLK = 2 MHz	MFM	50	—	—	

\*: This value, -50ns (min) indicated that Early (Late) signal changes 50ns (min) before WD falls down in worst case. See DISK DATA OUTPUT TIMING.

\*\* : All times are doubled when CLK = 1 MHz.

**WRITE DATA TIMING**

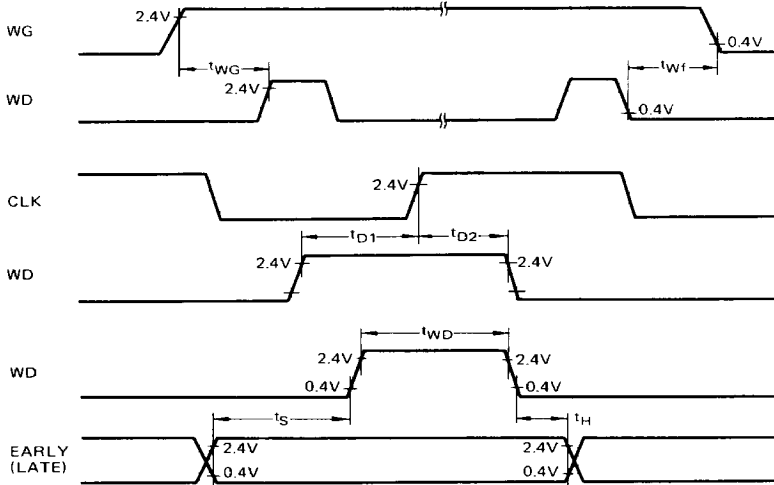

4

# MB8876A / MB8877A

## OTHER TIMINGS

Parameter	Symbol	Value			Unit
		Min	Typ	Max	
CLK Low Pulse Width	$t_{CD1}$	230	—	20000	ns
CLK High Pulse Width	$t_{CD2}$	200	—	20000	ns
STEP Pulse Width	MFM	2*	—	—	$\mu$ S
	FM	4*	—	—	$\mu$ S
DIRC Setup Time	$t_{DIR}$	12*	—	—	$\mu$ S
MR Pulse Width**	$t_{MR}$	50*	—	—	$\mu$ S
$\overline{IP}$ Pulse Width	$t_{IP}$	10*	—	—	$\mu$ S
$\overline{WF}$ Pulse Width	$t_{WF}$	10*	—	—	$\mu$ S
CLK Cycle Time	$t_{CYC}$	—	0.5*	—	$\mu$ S

\*: These Values are doubled when CLK = 1MHz.

\*\* : During Master Reset, CLK of more than 10 cycles are required.

## OTHER TIMINGS

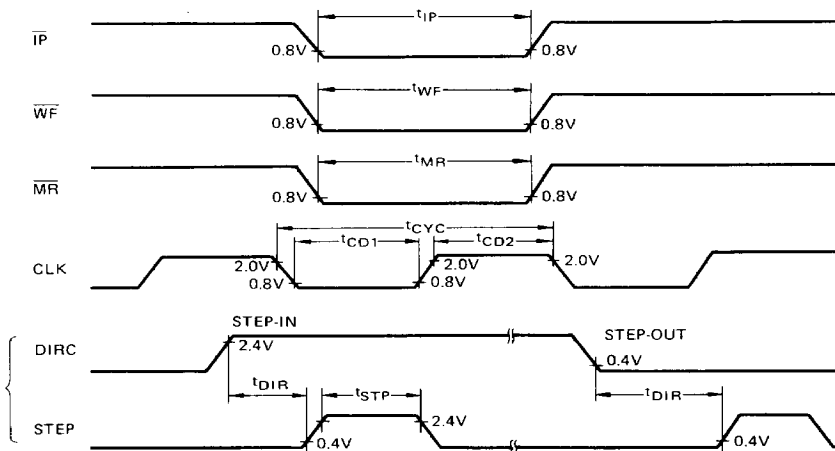



**PACKAGE DIMENSIONS** Dimensions in inches (millimeters)

**40-LEAD CERAMIC (METAL SEAL) DUAL IN-LINE PACKAGE**  
(Case No.: DIP-40C-A01)

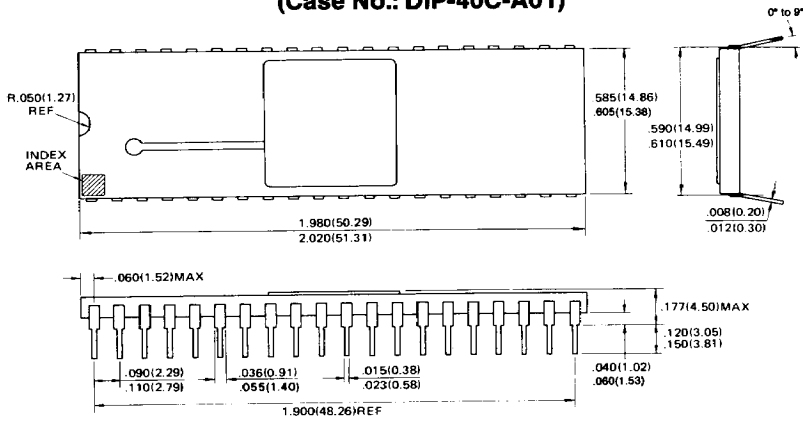

**40-LEAD PLASTIC DUAL IN-LINE PACKAGE**  
(Case No.: DIP-40P-M01)

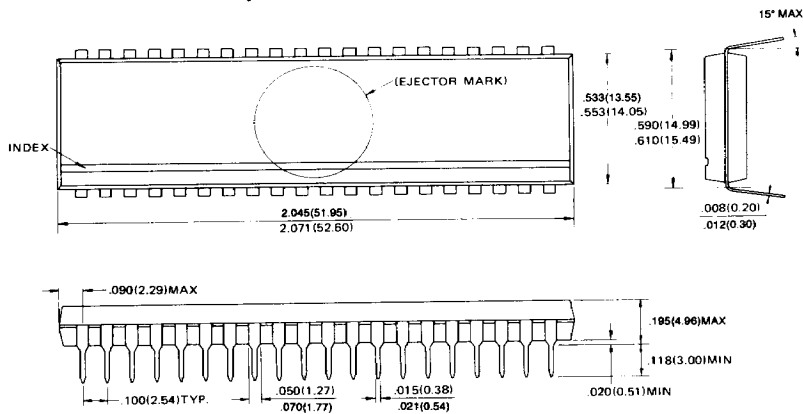

**FUJITSU**  
MICROELECTRONICS