



ICR620H-T11503 High Speed Lector62x

IMAGE-BASED CODE READERS

SICK
Sensor Intelligence.



Ordering information

Type	Part no.
ICR620H-T11503 High Speed	1055890

Other models and accessories → www.sick.com/Lector62x



Detailed technical data

Features

Reading field	Side
Focus	Teach auto focus
Sensor	CMOS matrix sensor, grayscale values
Sensor resolution	752 px x 480 px (WVGA)
Internal lighting	Red, Blue
Light source	Illumination LEDs: visible red light ($\lambda = 617 \pm 15 \text{ nm}$), visible blue light ($\lambda = 470 \pm 15 \text{ nm}$) Feedback spot: visible green light ($\lambda = 525 \pm 15 \text{ nm}$) Aiming laser: visible red light ($\lambda = 630 \dots 680 \text{ nm}$)
MTBF	75,000 h
LED class	1 (IEC 62471 (2006-07) / EN 62471 (2008-09))
Laser class	1, complies with 21 CFR 1040.10 except for the tolerance according to "Laser Notice No. 50" from June 24, 2007 (IEC 60825-1 (2007-3))
Scanning frequency	60 Hz, WVGA resolution
Focal length	7 mm
Code resolution	$\geq 0.1 \text{ mm}^{1)}$
Reading distance	30 mm ... 500 mm ^{1) 2)}

¹⁾ Valid for Data Matrix, PDF417, and 1D codes with good print quality.

²⁾ For details see reading field diagram.

Performance

Readable code structures	1D, 2D, Stacked
Bar code types	GS1-128 / EAN 128, UPC / GTIN / EAN, Interleaved 2 of 5, Pharmacode, GS1 DataBar, Code 39, Code 128, Codabar, Code 32, Code 93
2D code types	Data Matrix ECC200, GS1 Data-Matrix, PDF417, PDF417 Truncated, QR code
Code qualification	On the basis of ISO/IEC 16022, ISO/IEC 15415, ISO/IEC 15416, ISO/IEC 18004

No. of codes per reading interval	1 ... 50
No. of characters per reading interval	500 (for multiplexer function in CAN operation)
Internal image storage	135 MB
Transport speed	6 m/s

Interfaces

Ethernet TCP/IP	✓
Function	Host, AUX, OPC DA Server, FTP (image transmission)
Data transmission rate	10/100 MBit/s
PROFINET	✓
Function	PROFINET Single Port, PROFINET Dual Port (optional via external connection module CDF600-2)
Data transmission rate	10/100 MBit/s
EtherNet/IP™	✓
Data transmission rate	10/100 MBit/s
EtherCAT®	✓
Type of fieldbus integration	Optional over external fieldbus module CDF600
Serial	✓, RS-232, RS-422
Function	Host, AUX
Data transmission rate	0.3 kBaud ... 115.2 kBaud, AUX: 57.6 kBaud (RS-232)
CAN	✓
Function	SICK CAN sensor network (Master/Slave, Multiplexer/Server)
Data transmission rate	20 kbit/s ... 1 Mbit/s
CANopen	✓
Data transmission rate	20 kbit/s ... 1 Mbit/s
PROFIBUS DP	✓
Type of fieldbus integration	Optional over external fieldbus module CDF600-2
USB	✓
Remark	USB 2.0
Switching inputs	4 ("Sensor 1", "Sensor 2", 2 inputs via optional parameter storage CMC600 in CDB620/CDM420)
Switching outputs	4 ("Result 1", "Result 2", 2 outputs via CMC and CDB620/CDM420 or "Result 1", "Result 2", "Result 3", "Result 4" when using the 17-wire cable with open cable end)
Reading pulse	Switching inputs, non-powered, serial interface, Ethernet, CAN, auto pulse, presentation mode
Optical indicators	16 LEDs (5 x status display, 10 x LED bar graph, 1 green feedback spot)
Acoustic indicators	Beeper/buzzer (can be switched off, can be assigned a function to signal a result)
Operating elements	2 buttons (choose and start/stop functions)
Configuration software	SOPAS ET
Memory card	Micro SD memory card (flash card) max. 32 GB, optional
Data storage and retrieval	Image and data storage via microSD memory card, internal storage and external FTP
Maximum encoder frequency	300 Hz
External illumination control	Via digital output (max. 24 V trigger)

Mechanics/electronics

Electrical connection	1 x M12, 17-pin male connector 1 x M12, 4-pin Ethernet female connector
Operating voltage	10 V DC ... 30 V DC
Power consumption	Typ. 3 W
Output current	≤ 100 mA
Housing	Aluminum die cast
Housing color	Light blue (RAL 5012)
Enclosure rating	IP65 (EN 60529 (1991-10), EN 60529/A2 (2002-02))
Protection class	III
Electrical safety	EN 60950-1 (2006-04) / EN 60950-1/A11 (2009-03)
Weight	170 g
Dimensions (L x W x H)	71 mm x 43 mm x 35.6 mm ¹⁾
Lens	7 mm, integrated

¹⁾ Swivel connector is 17.8 mm longer.

Ambient data

Electromagnetic compatibility (EMC)	EN 61000-6-2 (2006-03) / EN 61000-6-2 (2009-05)
Vibration resistance	EN 60068-2-6 (2008-02)
Shock resistance	EN 60068-2-27 (2009-05)
Ambient operating temperature	0 °C ... +50 °C
Storage temperature	-20 °C ... +70 °C
Permissible relative humidity	90 %, Non-condensing
Ambient light immunity	2,000 lx, on code

Classifications

ECl@ss 5.0	27280103
ECl@ss 5.1.4	27280103
ECl@ss 6.0	27280103
ECl@ss 6.2	27280103
ECl@ss 7.0	27280103
ECl@ss 8.0	27280103
ECl@ss 8.1	27280103
ECl@ss 9.0	27280103
ETIM 5.0	EC002550
ETIM 6.0	EC002550
UNSPSC 16.0901	43211701

Dimensional drawing (Dimensions in mm (inch))

Lector62x Professional

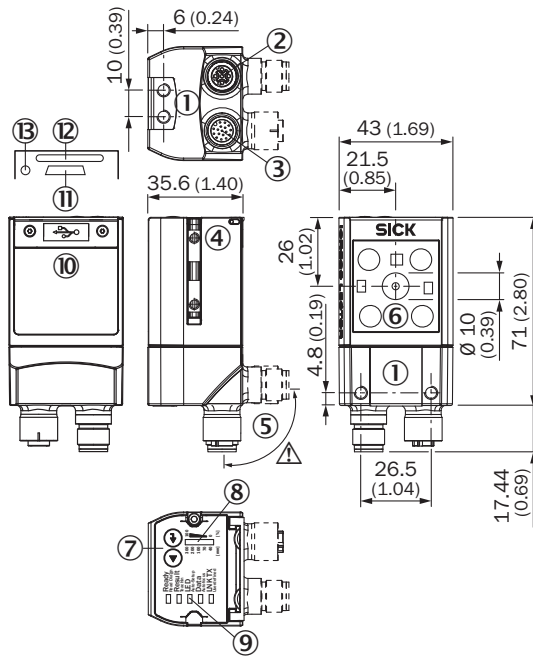

- ① M5 blind tapped holes, 5 mm deep (4 x), for mounting the sensor
- ② Ethernet connection
- ③ "Power/Serial Data/CAN/I/O" connection
- ④ Sliding nut M5, 5 mm deep (2 x), for mounting (as alternative)
- ⑤ Swivel connector unit
- ⑥ Reading field
- ⑦ Function button (2 x)
- ⑧ Bar graph display
- ⑨ LEDs for status display (2 levels), 5 x
- ⑩ Cover (flap)
- ⑪ "Micro USB" connection
- ⑫ Slot for microSD memory card
- ⑬ LED for microSD memory card

Reading field diagram

Working distance in mm (inch)

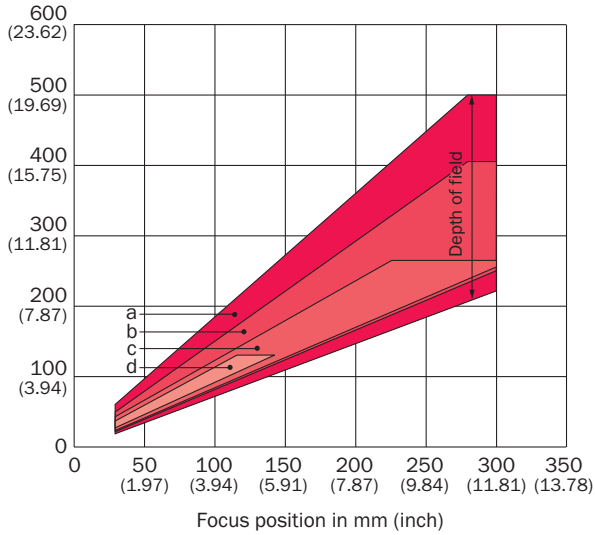

Resolution

- a: 1.00 mm (39.4 mil)
- b: 0.75 mm (29.5 mil)
- c: 0.50 mm (19.7 mil)
- d: 0.25 mm (9.8 mil)

Working distance in mm (inch)

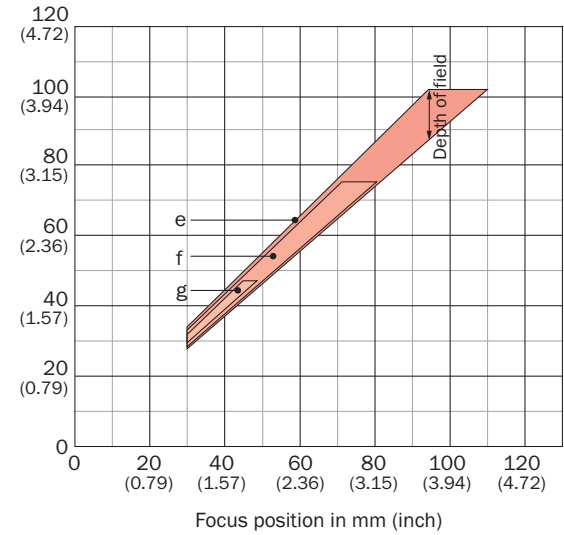

Resolution

- e: 0.20 mm (7.9 mil)
- f: 0.15 mm (5.9 mil)
- g: 0.10 mm (3.9 mil)

Field of view

Field of view in mm² (sq inch)

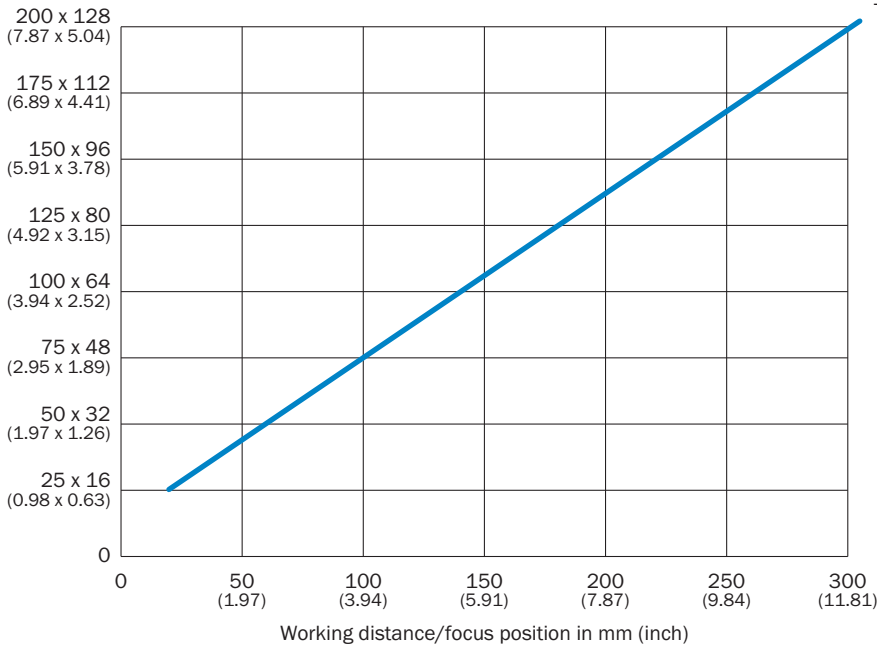



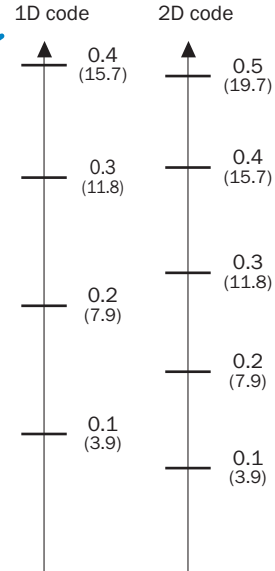

Min. resolution in mm (mil)



— f = 7 mm (ICR620H-T11503, ICR620D-T11503, ICR620D-T17503, ICR620C-T11503S50)

Recommended accessories

Other models and accessories → www.sick.com/Lector62x

	Brief description	Type	Part no.
Mounting brackets and plates			
	Bracket with adapter board	Mounting bracket	2042902
Modules			
	Small connection module for one sensor, 4 cable glands, base for CMC600	CDB620-001	1042256
	Fieldbus proxy/gateway for connecting identification sensors to PROFIBUS-DP networks (PROFIBUS interface: 2 x M12, male connector/female connector, 5-pin)	CDF600-2100	1058965
	Fieldbus proxy/gateway for connecting identification sensors to PROFIBUS-DP networks (PROFIBUS interface: 1 x D-Sub, female connector, 9-pin)	CDF600-2103	1058966
Plug connectors and cables			
	Head A: female connector, M12, 17-pin, straight Head B: male connector, D-Sub-HD, 15-pin, straight Cable: Power, serial, CAN, digital I/Os, shielded, 2 m	Connection cable (male connector - female connector)	2055419
	Head A: male connector, M12, 4-pin, D-coded Head B: male connector, M12, 4-pin, D-coded Cable: Ethernet, PUR, shielded, 2 m	SSL-1204-G02ME	6034420
	Head A: male connector, M12, 4-pin, straight, D-coded Head B: male connector, RJ45, 8-pin, straight Cable: Ethernet, drag chain use, PUR, shielded, 2 m	SSL-2J04-G02ME	6034414
	Head A: male connector, USB-A Head B: male connector, Micro-B Cable: USB 2.0, unshielded, 2 m	USB cable	6036106

SICK AT A GLANCE

SICK is one of the leading manufacturers of intelligent sensors and sensor solutions for industrial applications. A unique range of products and services creates the perfect basis for controlling processes securely and efficiently, protecting individuals from accidents and preventing damage to the environment.

We have extensive experience in a wide range of industries and understand their processes and requirements. With intelligent sensors, we can deliver exactly what our customers need. In application centers in Europe, Asia and North America, system solutions are tested and optimized in accordance with customer specifications. All this makes us a reliable supplier and development partner.

Comprehensive services complete our offering: SICK LifeTime Services provide support throughout the machine life cycle and ensure safety and productivity.

For us, that is “Sensor Intelligence.”

WORLDWIDE PRESENCE:

Contacts and other locations –www.sick.com