



# ICR620D-T31503 DPM Plus

Lector62x

IMAGE-BASED CODE READERS

**SICK**  
Sensor Intelligence.



Illustration may differ



### Ordering information

Type	Part no.
ICR620D-T31503 DPM Plus	1064255

Other models and accessories → [www.sick.com/Lector62x](http://www.sick.com/Lector62x)

### Detailed technical data

#### Features

<b>Reading field</b>	Side
<b>Focus</b>	Teach auto focus
<b>Sensor</b>	CMOS matrix sensor, grayscale values
<b>Sensor resolution</b>	752 px x 480 px (WVGA)
<b>Internal lighting</b>	Red, Blue
<b>Light source</b>	Illumination LEDs: visible red light ( $\lambda = 617 \pm 15 \text{ nm}$ ), visible blue light ( $\lambda = 470 \pm 15 \text{ nm}$ ) Feedback spot: visible green light ( $\lambda = 525 \pm 15 \text{ nm}$ ) Aiming laser: visible red light ( $\lambda = 630 \dots 680 \text{ nm}$ )
<b>MTBF</b>	75,000 h
<b>LED class</b>	1 (IEC 62471 (2006-07) / EN 62471 (2008-09))
<b>Laser class</b>	1, complies with 21 CFR 1040.10 except for the tolerance according to "Laser Notice No. 50" from June 24, 2007 (IEC 60825-1 (2007-3))
<b>Scanning frequency</b>	60 Hz, WVGA resolution
<b>Focal length</b>	12 mm
<b>Code resolution</b>	$\geq 0.15 \text{ mm}^1$
<b>Reading distance</b>	120 mm ... 950 mm <sup>1) 2)</sup>

<sup>1)</sup> Valid for Data Matrix, PDF417, and 1D codes with good print quality.

<sup>2)</sup> For details see reading field diagram.

#### Performance

<b>Readable code structures</b>	1D, 2D, Stacked, DPM
<b>Bar code types</b>	GS1-128 / EAN 128, UPC / GTIN / EAN, Interleaved 2 of 5, Pharmacode, GS1 DataBar, Code 39, Code 128, Codabar, Code 32, Code 93
<b>2D code types</b>	Data Matrix ECC200, GS1 Data-Matrix, PDF417, QR code, PDF417 Truncated

<b>Code qualification</b>	On the basis of ISO/IEC 16022, ISO/IEC 15415, ISO/IEC 18004, ISO TR 29158/AIM DPM
<b>No. of codes per reading interval</b>	1 ... 50
<b>No. of characters per reading interval</b>	500 (for multiplexer function in CAN operation)
<b>Internal image storage</b>	135 MB
<b>Transport speed</b>	4 m/s

## Interfaces

<b>Ethernet TCP/IP</b>	✓
Function	Host, AUX, OPC DA Server, FTP (image transmission)
Data transmission rate	10/100 MBit/s
<b>PROFINET</b>	✓
Function	PROFINET Single Port, PROFINET Dual Port (optional via external connection module CDF600-2)
Data transmission rate	10/100 MBit/s
<b>EtherNet/IP™</b>	✓
Data transmission rate	10/100 MBit/s
<b>EtherCAT®</b>	✓
Type of fieldbus integration	Optional over external fieldbus module CDF600
<b>Serial</b>	✓, RS-232, RS-422
Function	Host, AUX
Data transmission rate	0.3 kBaud ... 115.2 kBaud, AUX: 57.6 kBaud (RS-232)
<b>CAN</b>	✓
Function	SICK CAN sensor network (Master/Slave, Multiplexer/Server)
Data transmission rate	20 kbit/s ... 1 Mbit/s
<b>CANopen</b>	✓
Data transmission rate	20 kbit/s ... 1 Mbit/s
<b>PROFIBUS DP</b>	✓
Type of fieldbus integration	Optional over external fieldbus module CDF600-2
<b>USB</b>	✓
Remark	USB 2.0
<b>Switching inputs</b>	4 ("Sensor 1", "Sensor 2", 2 inputs via optional parameter storage CMC600 in CDB620/CDM420)
<b>Switching outputs</b>	4 ("Result 1", "Result 2", 2 outputs via CMC and CDB620/CDM420 or "Result 1", "Result 2", "Result 3", "Result 4" when using the 17-wire cable with open cable end)
<b>Reading pulse</b>	Switching inputs, non-powered, serial interface, Ethernet, CAN, auto pulse, presentation mode
<b>Optical indicators</b>	16 LEDs (5 x status display, 10 x LED bar graph, 1 green feedback spot)
<b>Acoustic indicators</b>	Beeper/buzzer (can be switched off, can be assigned a function to signal a result)
<b>Operating elements</b>	2 buttons (choose and start/stop functions)
<b>Configuration software</b>	SOPAS ET
<b>Memory card</b>	Micro SD memory card (flash card) max. 32 GB, optional
<b>Data storage and retrieval</b>	Image and data storage via microSD memory card, internal storage and external FTP
<b>Maximum encoder frequency</b>	300 Hz
<b>External illumination control</b>	Via digital output (max. 24 V trigger)

## Mechanics/electronics

<b>Electrical connection</b>	1 x M12, 17-pin male connector 1 x M12, 4-pin Ethernet female connector
<b>Operating voltage</b>	10 V DC ... 30 V DC
<b>Power consumption</b>	Typ. 3 W
<b>Output current</b>	≤ 100 mA
<b>Housing</b>	Aluminum die cast
<b>Housing color</b>	Light blue (RAL 5012)
<b>Enclosure rating</b>	IP65 (EN 60529 (1991-10), EN 60529/A2 (2002-02))
<b>Protection class</b>	III
<b>Electrical safety</b>	EN 60950-1 (2006-04) / EN 60950-1/A11 (2009-03)
<b>Weight</b>	170 g
<b>Dimensions (L x W x H)</b>	71 mm x 43 mm x 35.6 mm <sup>1)</sup>
<b>Lens</b>	12 mm, integrated

<sup>1)</sup> Swivel connector is 17.8 mm longer.

## Ambient data

<b>Electromagnetic compatibility (EMC)</b>	EN 61000-6-2 (2006-03) / EN 61000-6-2 (2009-05)
<b>Vibration resistance</b>	EN 60068-2-6 (2008-02)
<b>Shock resistance</b>	EN 60068-2-27 (2009-05)
<b>Ambient operating temperature</b>	0 °C ... +50 °C
<b>Storage temperature</b>	-20 °C ... +70 °C
<b>Permissible relative humidity</b>	90 %, Non-condensing
<b>Ambient light immunity</b>	2,000 lx, on code

## Classifications

<b>ECl@ss 5.0</b>	27280103
<b>ECl@ss 5.1.4</b>	27280103
<b>ECl@ss 6.0</b>	27280103
<b>ECl@ss 6.2</b>	27280103
<b>ECl@ss 7.0</b>	27280103
<b>ECl@ss 8.0</b>	27280103
<b>ECl@ss 8.1</b>	27280103
<b>ECl@ss 9.0</b>	27280103
<b>ETIM 5.0</b>	EC002550
<b>ETIM 6.0</b>	EC002550
<b>UNSPSC 16.0901</b>	43211701

Dimensional drawing (Dimensions in mm (inch))

Lector62x Professional

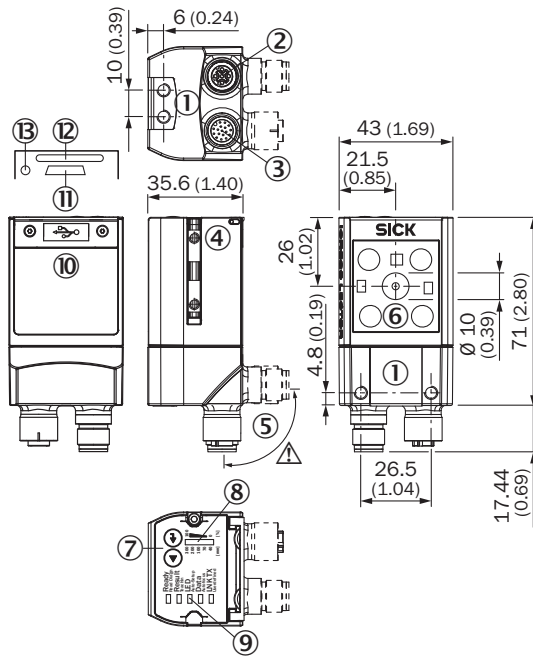

- ① M5 blind tapped holes, 5 mm deep (4 x), for mounting the sensor
- ② Ethernet connection
- ③ "Power/Serial Data/CAN/I/O" connection
- ④ Sliding nut M5, 5 mm deep (2 x), for mounting (as alternative)
- ⑤ Swivel connector unit
- ⑥ Reading field
- ⑦ Function button (2 x)
- ⑧ Bar graph display
- ⑨ LEDs for status display (2 levels), 5 x
- ⑩ Cover (flap)
- ⑪ "Micro USB" connection
- ⑫ Slot for microSD memory card
- ⑬ LED for microSD memory card

Reading field diagram

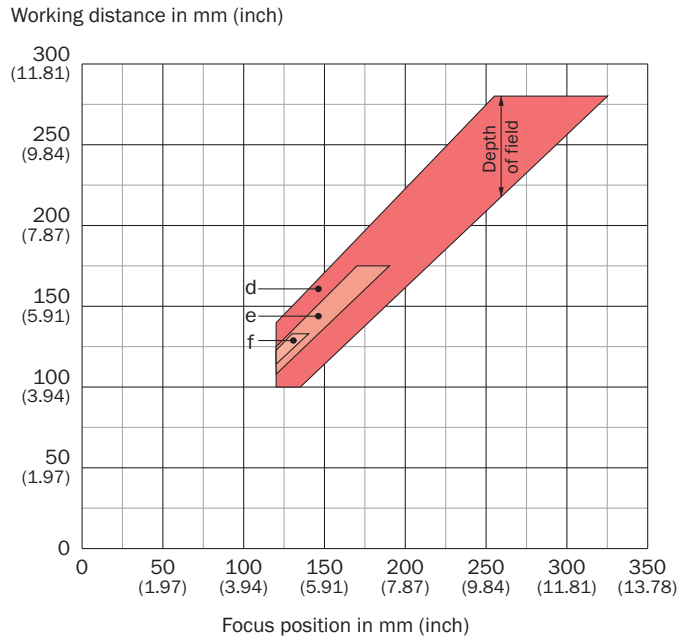
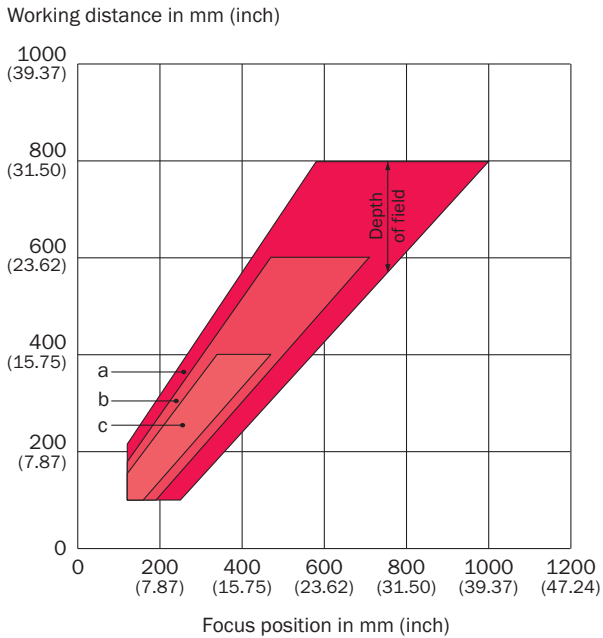

Field of view

Field of view in mm<sup>2</sup> (sq inch)

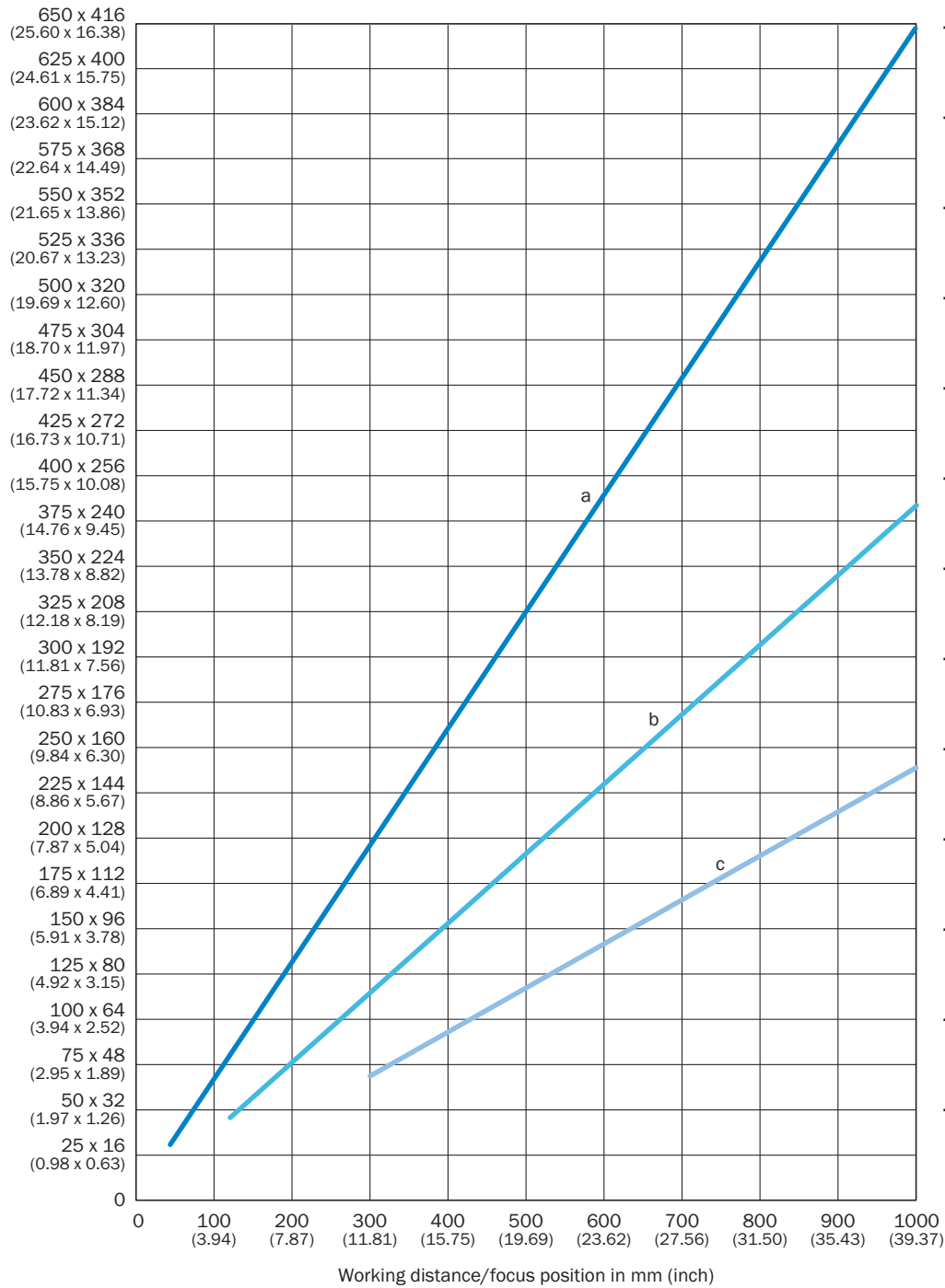



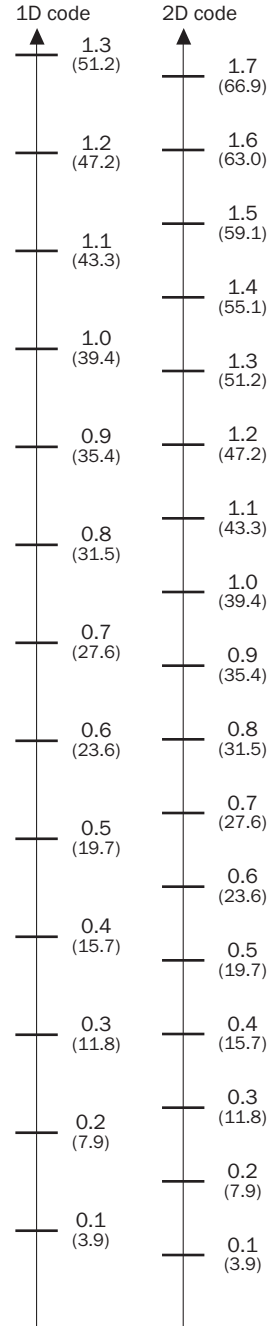

Min. resolution in mm (mil)



- a: f = 7 mm (ICR620E-H12013, ICR620S-T11503, ICR620S-T11504)
- b: f = 12 mm (ICR620D-T31503)
- c: f = 18 mm (ICR620D-T51503)

### Recommended accessories

Other models and accessories → [www.sick.com/Lector62x](http://www.sick.com/Lector62x)

	Brief description	Type	Part no.
<b>Mounting brackets and plates</b>			
	Bracket with adapter board	Mounting bracket	2042902
<b>Modules</b>			
	Small connection module for one sensor, 4 cable glands, base for CMC600	CDB620-001	1042256
	Fieldbus proxy/gateway for connecting identification sensors to PROFIBUS-DP networks (PROFIBUS interface: 2 x M12, male connector/female connector, 5-pin)	CDF600-2100	1058965
	Fieldbus proxy/gateway for connecting identification sensors to PROFIBUS-DP networks (PROFIBUS interface: 1 x D-Sub, female connector, 9-pin)	CDF600-2103	1058966
<b>Plug connectors and cables</b>			
	Head A: female connector, M12, 17-pin, straight Head B: male connector, D-Sub-HD, 15-pin, straight Cable: Power, serial, CAN, digital I/Os, shielded, 2 m	Connection cable (male connector - female connector)	2055419
	Head A: male connector, M12, 4-pin, D-coded Head B: male connector, M12, 4-pin, D-coded Cable: Ethernet, PUR, shielded, 2 m	SSL-1204-G02ME	6034420
	Head A: male connector, M12, 4-pin, straight, D-coded Head B: male connector, RJ45, 8-pin, straight Cable: Ethernet, drag chain use, PUR, shielded, 2 m	SSL-2J04-G02ME	6034414
	Head A: male connector, USB-A Head B: male connector, Micro-B Cable: USB 2.0, unshielded, 2 m	USB cable	6036106



## SICK AT A GLANCE

SICK is one of the leading manufacturers of intelligent sensors and sensor solutions for industrial applications. A unique range of products and services creates the perfect basis for controlling processes securely and efficiently, protecting individuals from accidents and preventing damage to the environment.

We have extensive experience in a wide range of industries and understand their processes and requirements. With intelligent sensors, we can deliver exactly what our customers need. In application centers in Europe, Asia and North America, system solutions are tested and optimized in accordance with customer specifications. All this makes us a reliable supplier and development partner.

Comprehensive services complete our offering: SICK LifeTime Services provide support throughout the machine life cycle and ensure safety and productivity.

For us, that is “Sensor Intelligence.”

## WORLDWIDE PRESENCE:

Contacts and other locations –[www.sick.com](http://www.sick.com)